

## STELLA-FRESNEL

~25° beam for warehouse and outdoor lighting.  
Compatible with up to 30 mm LES size COBs.

### TECHNICAL SPECIFICATIONS:

Dimensions	Ø 90.0 mm
Height	23 mm
Fastening	screw
Colour	black
Box size	480 x 280 x 300 mm
Box weight	4 kg
Quantity in Box	80 pcs
ROHS compliant	yes ⓘ



### MATERIAL SPECIFICATIONS:

Component	Type	Material	Colour
STELLA-FRESNEL	Single lens	Silicone	clear
STELLA-FRAME	Holder	PA66	black

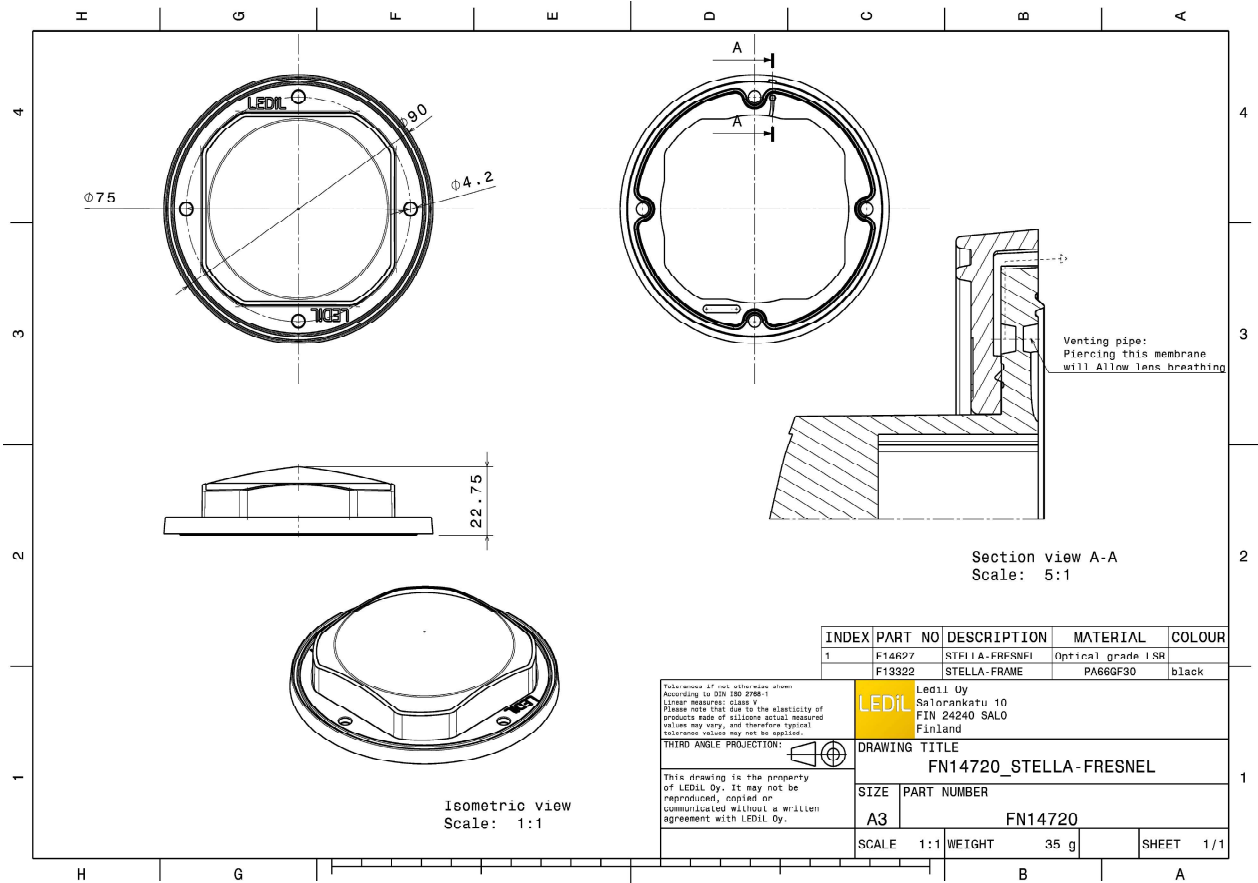

#### PHOTOMETRIC DATA (MEASURED):



LED CMA3090  
 FWHM 35.0°  
 Efficiency 88 %  
 Peak intensity 1.200 cd/lm  
 LEDs/each optic 1  
 Light colour White  
 Required components:

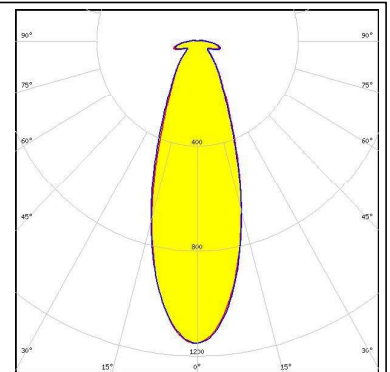
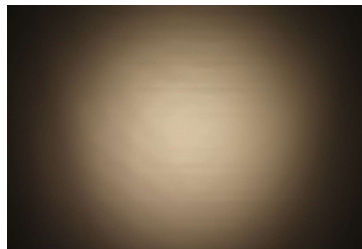

LED CXA/B 1816 & CXA/B 1820 & CXA 1850  
 FWHM 24.0°  
 Efficiency 84 %  
 Peak intensity 1.900 cd/lm  
 LEDs/each optic 1  
 Light colour White  
 Required components:

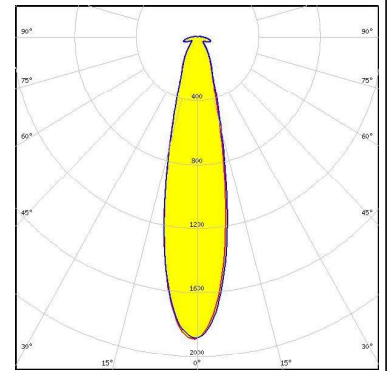
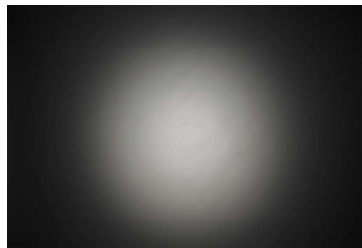

LED CXA/B 1830  
 FWHM 26.0°  
 Efficiency 85 %  
 Peak intensity 1.600 cd/lm  
 LEDs/each optic 1  
 Light colour White  
 Required components:  
 C14305\_STELLA-CLAMP-CXA15-18

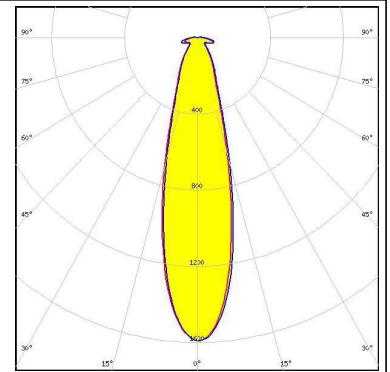
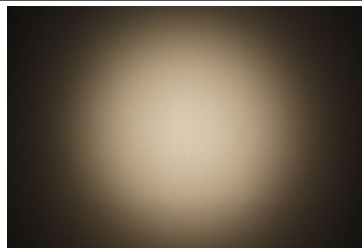

LED CXA/B 25xx  
 FWHM 32.0°  
 Efficiency 85 %  
 Peak intensity 1.200 cd/lm  
 LEDs/each optic 1  
 Light colour White  
 Required components:  
 Bender Wirth: 439 Typ L3

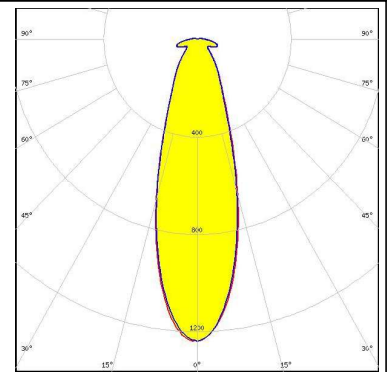
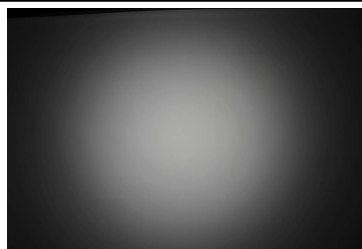

#### PHOTOMETRIC DATA (MEASURED):



LED CXA/B 25xx  
 FWHM 33.0°  
 Efficiency 84 %  
 Peak intensity 1.000 cd/lm  
 LEDs/each optic 1  
 Light colour White  
 Required components:

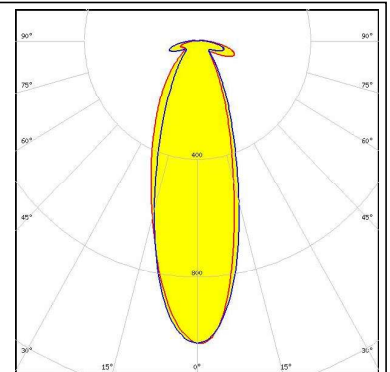
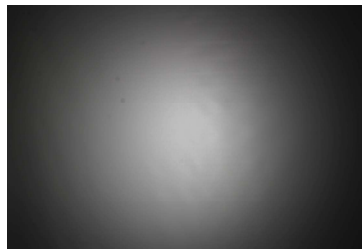

LED CXA/B 25xx  
 FWHM 31.0°  
 Efficiency 86 %  
 Peak intensity 1.200 cd/lm  
 LEDs/each optic 1  
 Light colour White  
 Required components:

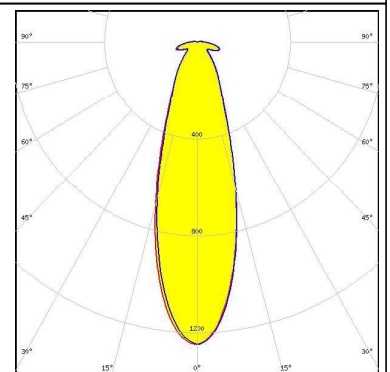
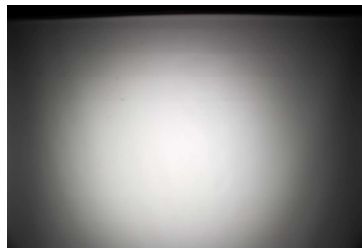

LED CXA/B 30xx  
 FWHM 37.0°  
 Efficiency 88 %  
 Peak intensity 1.000 cd/lm  
 LEDs/each optic 1  
 Light colour White  
 Required components:  
 BJB: 47.319.2151

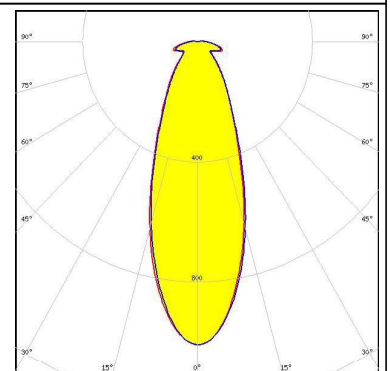
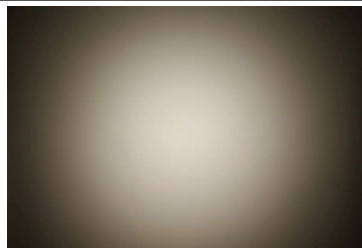

LED LUXEON CoB 1211  
 FWHM 33.0°  
 Efficiency 85 %  
 Peak intensity 1.100 cd/lm  
 LEDs/each optic 1  
 Light colour White  
 Required components:  
 Bender Wirth: 431 Typ L3

