



RoHS

Specification

规格书

Customer Name:

客户名称: _____

Customer P/N:

客户品号: _____

Factory P/N:

公司品号: HL-633U22YD-R

Sending Date:

送样日期: _____

Client approval 客户审核			Hongli approval 鸿利智汇审核		
Approval 核准	Audit 确认	Confirmation 制作	Approval 核准	Audit 确认	Confirmation 制作
<input type="checkbox"/> Qualified 接受		<input type="checkbox"/> Disqualified 不接受	DATE: 日期:		

Address : Dangui Road NO. 1 Dantu Area Zhenjiang City Jiangsu Province

地址 : 江苏省镇江市丹徒区丹桂路 1 号

Tel/电话 : 0511-88786599 Fax/传真 : 0511-88786599 Web/网址 : www.goozo.com.cn

注:

- 1.此规格书以中英文方式书写,若有冲突以中文版本为准文本.
- 2.此规格书的最终解释权归属江苏鸿利国泽光电科技有限公司



ATTENTION

OBSERVE PRECAUTIONS
FOR HANDLING
ELECTROSTATIC
DISCHARGE
SENSITIVE
DEVICES

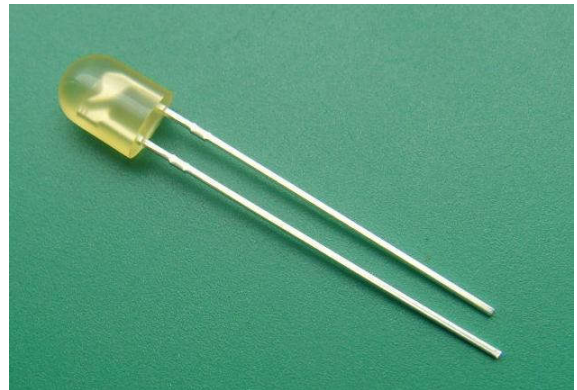

Features

- $\phi 5$ OVAL TUPE LAMP LED
- LOW POWER CONSUMPTION.
- WIDE VIEWING ANGLE.
- IDEAL FOR BACKLIGHT AND INDICATOR.
- PACKAGE: 1000PCS / BAG.

Package Dimensions

Description

This devices are made with TS AlGaInP.

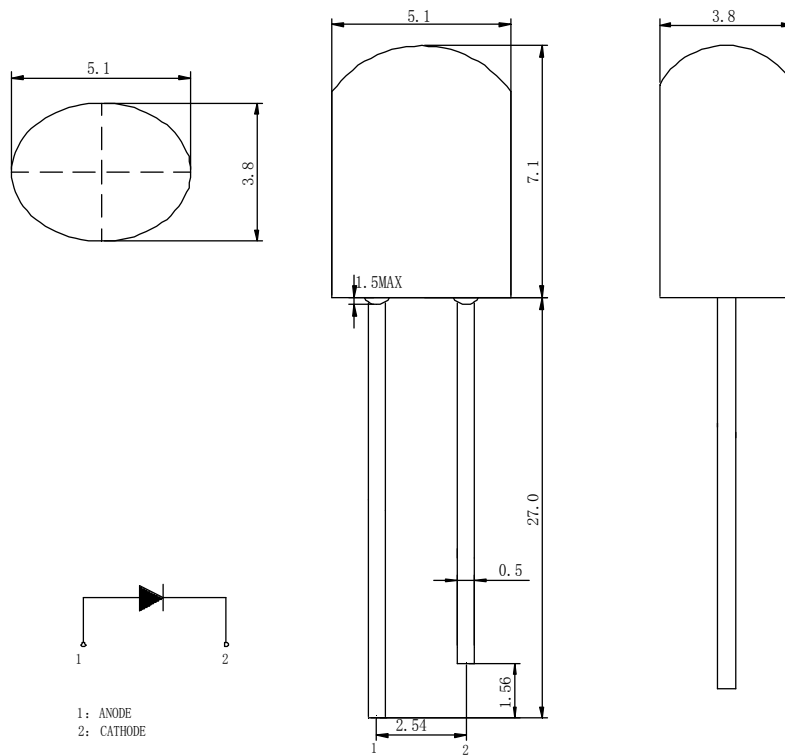

Tolerance Grade	Dimension Tolerance (UNIT:mm)			
	0.5~3	3~6	6~30	30~120
	± 0.1	± 0.2	± 0.3	± 0.5
Chip		Lens Color		
Material	Emitting Color	Color Diffused		
AlGaInP	Yellow			



■ Absolute Maximum Rating

Item	Symbol	Value	Unit
Forward Current	I _F	30	mA
Peak Forward Current*	I _{FP}	120	mA
Reverse Voltage	V _R	5	V
Power Dissipation	P _D	80	mW
Electrostatic discharge	E _{SD}	1000	V
Operation Temperature	T _{opr}	-30~+80	°C
Storage Temperature	T _{stg}	-40~+80	°C
Lead Soldering Temperature*	T _{sol}	Max. 260°C for 5sec Max.	

*I_{FP} Conditions: Pulse Width ≤ 10msec

*T_{sol} Conditions: 3mm from the base of the epoxy bulb

■ Typical Optical/ Electrical Characteristics Ta=25°C

Item	Symbol	Condition	Rank	Min.	Typ.	Max.	Unit
Luminous Intensity	I _v	I _F =20mA	S	1015		1320	mcd
			T	1320		1715	mcd
			U	1715		2230	mcd
Forward Voltage	V _F			1.8	2.2	2.6	V
Viewing Angle	2θ 1/2			--	100/50	--	deg
Dominant Wavelength	λ _D			585	--	595	nm
Recommend Forward Current	I _{F(rec)}	--		--	--	20	mA
Reverse Current	I _R	V _r =5V		--	--	10	uA

Notes:

Tolerance : V_F ± 0.1V, λ_d ± 2 nm, I_v(φ V) ± 15%, 2θ 1/2 ± 15%



■ Reliability Performance
Test Items And Result

Test Classification	Test Item	Test Conditions	Test Duration	Sample Size	AC/RE
Life Test	Room Temperature DC Operating Life Test	Ta=25°C±5°C, IF=20mA	1000 hrs	22 pcs	0/1
Environment Test	Thermal Shock Test	100°C±5°C 5min ↑↓ -40°C±5°C 5min.	100 cycles	22 pcs	0/1
	Temperature Cycle Test	100°C±5°C 30min ↑↓5min -40°C±5°C 30min.	100 cycles	22 pcs	0/1
	High Temperature & High Humidity Test	85°C±5°C/85% RH IF=5mA	1000 hrs	22 pcs	0/1
	High Temperature Storage	Ta=100°C±5°C	1000 hrs	22 pcs	0/1
	Low Temperature Storage	Ta=-40°C±5°C	1000 hrs	22 pcs	0/1
Mechanical Test	Resistance to Soldering Heat	Temp=260°Cmax T=5sec max	1times	22 pcs	0/1
	Lead Integrity	Load 2.5N(0.25kgf) 0° ~ 90° ~0°	3times	22 pcs	0/1

Forward Current vs. Ambient Temperature

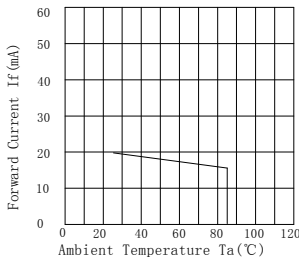

Relative Intensity vs. Ambient Temperature

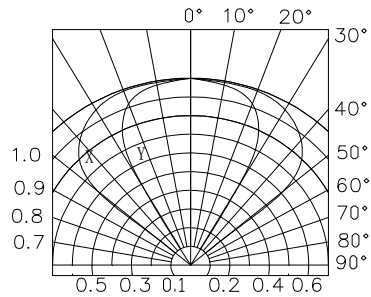
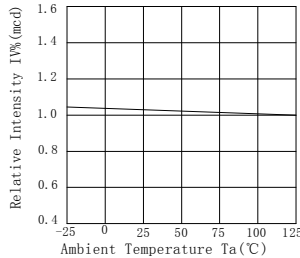

Forward Current vs. Forward Voltage

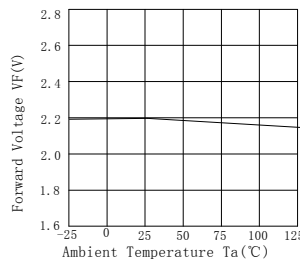
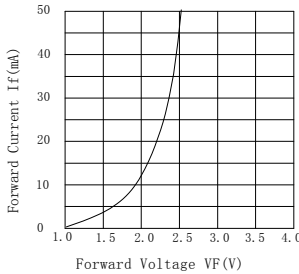

Luminous Spectrum (Ta=25°C) SPECTRAL RADIANCE

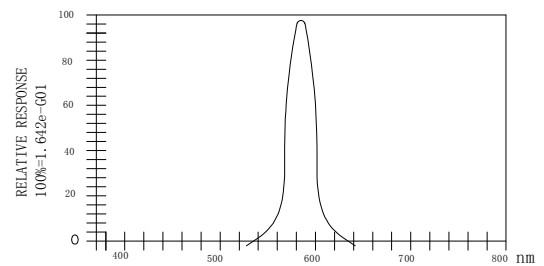



Soldering:

1. Manual Of Soldering

The temperature of the iron tip should not be higher than 300°C and Soldering within 3 seconds per solder-land is to be observed.

2. DIP soldering (Wave Soldering):

Preheating: 120°C~150°C, within 120~180 sec.

Operation heating: 245°C ± 5°C within 5 sec. 260°C (Max)

Gradual Cooling (Avoid quenching).

