



PC35A25 V0 Product Specification

Approval Sheet

PC35A25

Product Specification



Product	Yellow SMD LED
Part Number	PC35A25 V0
Issue Date	2021/07/14

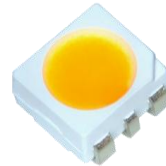

■ Features

- ✓ Yellow SMD LED (L x W x H) of 3.4 x 3.3 x 1.9 mm
- ✓ AEC-Q101 Rev. D and IEC 60810 qualification
- ✓ Dice Technology : InGaN
- ✓ Qualified according to JEDEC moisture sensitivity Level 2
- ✓ Cu Alloy with Gold plated lead frame
- ✓ Environmental friendly ; RoHS compliance
- ✓ ESD protection
- ✓ Packing : 500 pcs/reel

■ Applications

- ✓ Signaling
- ✓ Indicator light
- ✓ Exterior Automotive Lighting
- ✓ Automotive Interior Lighting

Outline Dimension

PC35A25

Product Specification

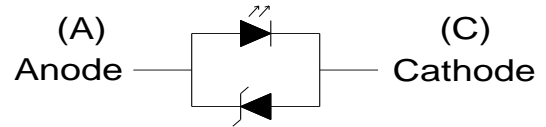
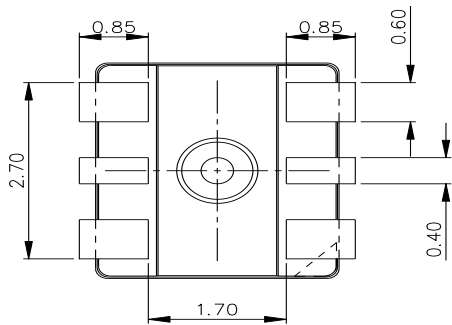
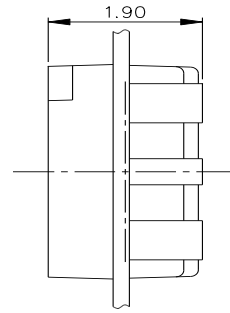
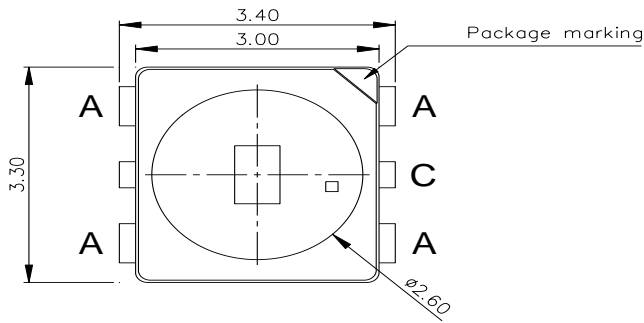

Package Dimension

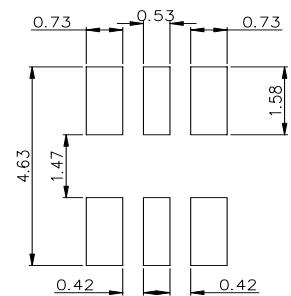
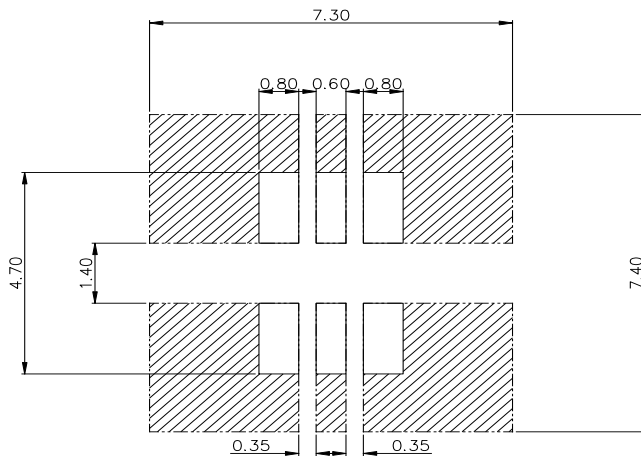

Unit: mm, Tolerance: $\pm 0.1\text{mm}$

Recommended Soldering Pad



-  Exposed Cu for soldering
-  Cu area with solder mask for heat dissipation

Performance

PC35A25

Product Specification

■ Electro-Optical Characteristics (Ta=25°C)

Parameter	Symbol	Condition	Min.	Typ.	Max.	Unit
Forward Voltage	V_F	$I_F = 140 \text{ mA}$	2.8	3.15	3.4	V
Luminous Flux	I_v		20.1	31	42.2	lm
Color	CIE		(0.575, 0.415)			-
View Angle	θ		120			deg
Thermal Resistance	R_{th}		50			°C/W

* The Forward Voltage tolerance is $\pm 0.05\text{V}$

* The luminous intensity tolerance is $\pm 8\%$

* Tolerance of measurements of the Chromaticity Coordinate is ± 0.005 .

■ Absolute Maximum Ratings

Parameter	Symbol	value	Unit
DC Forward Current	I_F	250	mA
Power Dissipation	P_D	0.85	W
Pulse Forward Current ⁽¹⁾	I_{FP}	600	mA
Storage Temperature	T_{stg}	-40 ~ +125	°C
Operating Temperature	T_{opr}	-40 ~ +115	°C
Junction Temperature	T_J	125	°C
Junction Temperature for short time applications ⁽²⁾	T_J	150	°C
ESD (HBM)	ESD_{HBM}	8000	V
Assembly Temperature	T_{sld}	260	°C

(1) IFP Condition: $t < 10 \mu\text{s}$; $D = 0.005$; $T_S = 25 \text{ }^\circ\text{C}$

(2) The median lifetime (L70/B50) for $T_j = 150^\circ\text{C}$ is 100h.

Binning

PC35A25

Product Specification

Chromaticity Coordinates

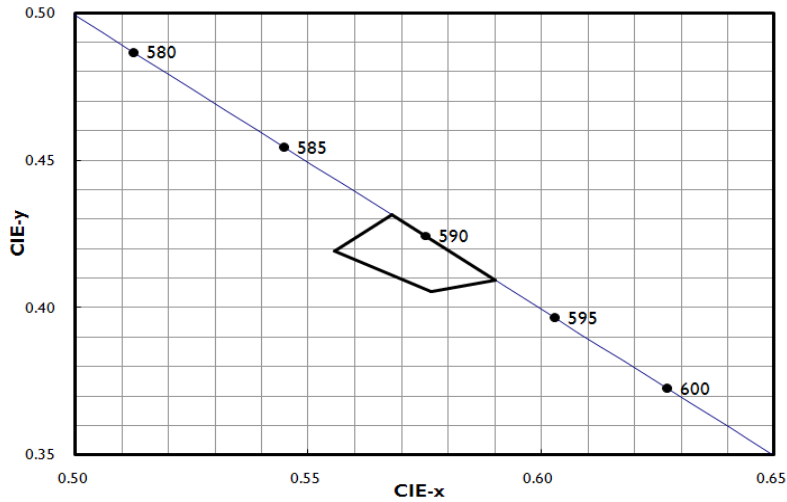

Bin code definition

V _F Rank	Luminous Flux Rank	CIE Rank
A	A8	A2000

V _F Rank	Condition	Min. (V)	Max. (V)
A	I _F = 140 mA T _j = 25°C	2.8	3.0
B		3.0	3.2
C		3.2	3.4

Luminous Flux Rank	Condition	Min. I _v (lm)	Max. I _v (lm)
A6	I _F = 140 mA T _j = 25°C	20.1	23.1
A7		23.1	26.6
A8		26.6	30.6
A9		30.6	35.2
AA		35.2	42.2

* The Forward Voltage tolerance is ±0.05V

* The luminous intensity tolerance is ± 8%

* Tolerance of measurements of the Chromaticity Coordinate is ±0.005.

CIE Rank

CIE Rank	x1	y1	x2	y2	x3	y3	x4	y4
A2000	0.5680	0.4315	0.5901	0.4094	0.5763	0.4054	0.5557	0.4192

Characteristics

PC35A25

Product Specification

■ Color Spectrum, $I_F=140\text{mA}$, $T_a=25^\circ\text{C}$

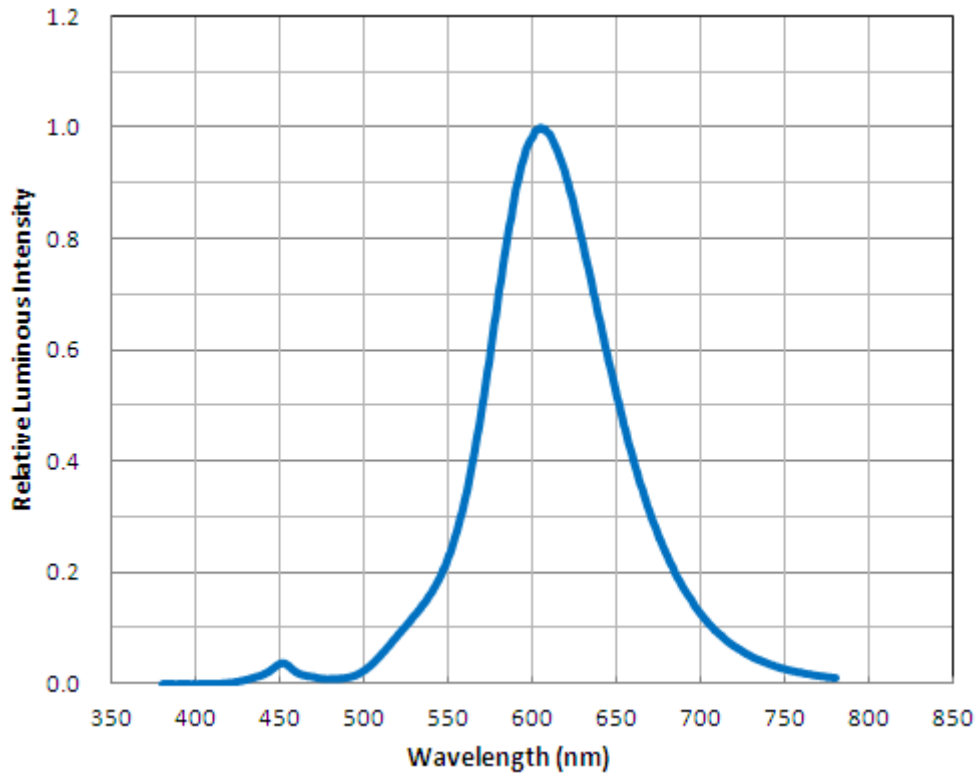

■ Viewing Angle Distribution, $I_F=140\text{mA}$, $T_a=25^\circ\text{C}$

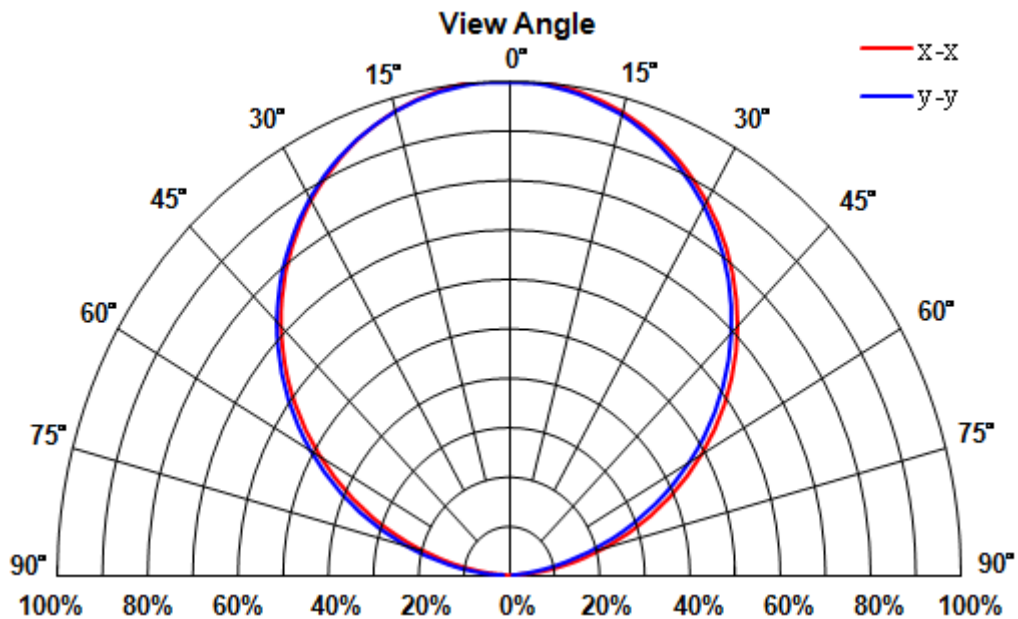

■ Forward Voltage vs. Forward Current, Ta=25°C

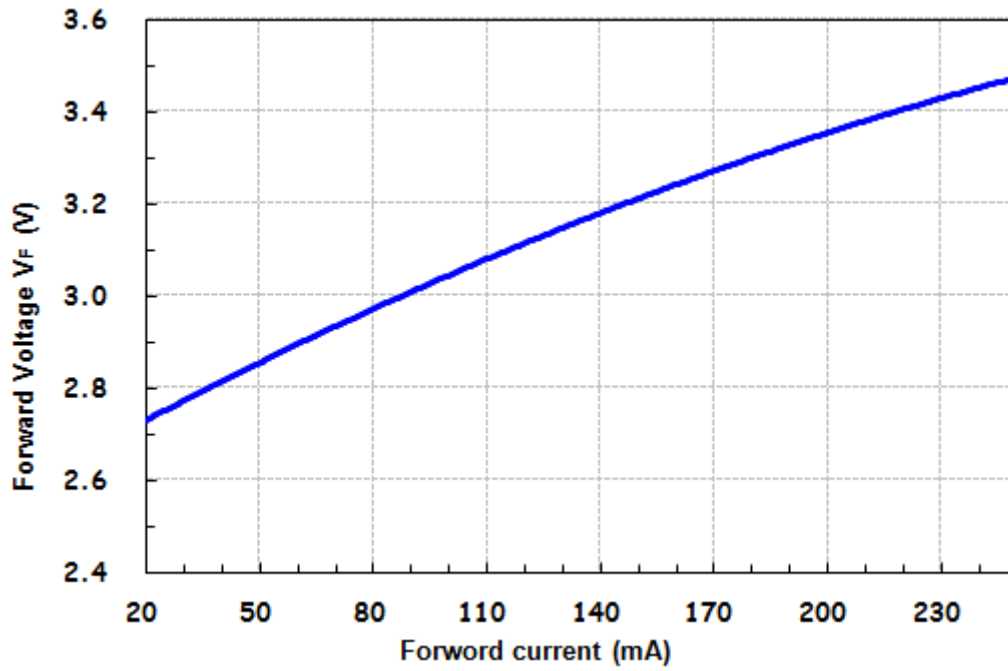

■ Forward Current vs. Relative Luminosity Intensity, Ta=25°C

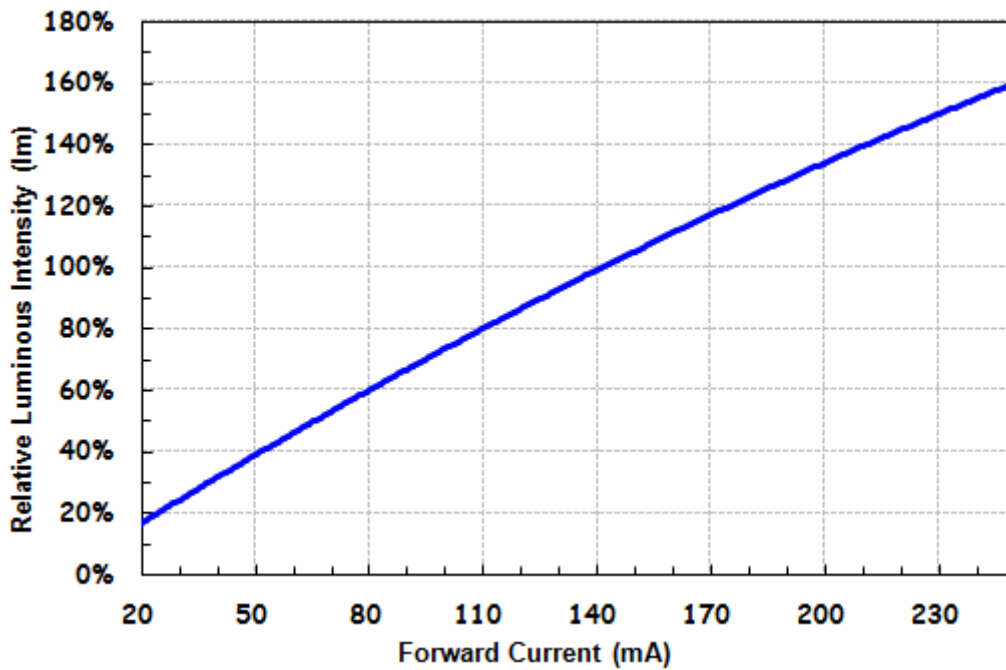

■ **Forward Current vs. CIE X, Y Shift, $T_a=25^\circ\text{C}$**

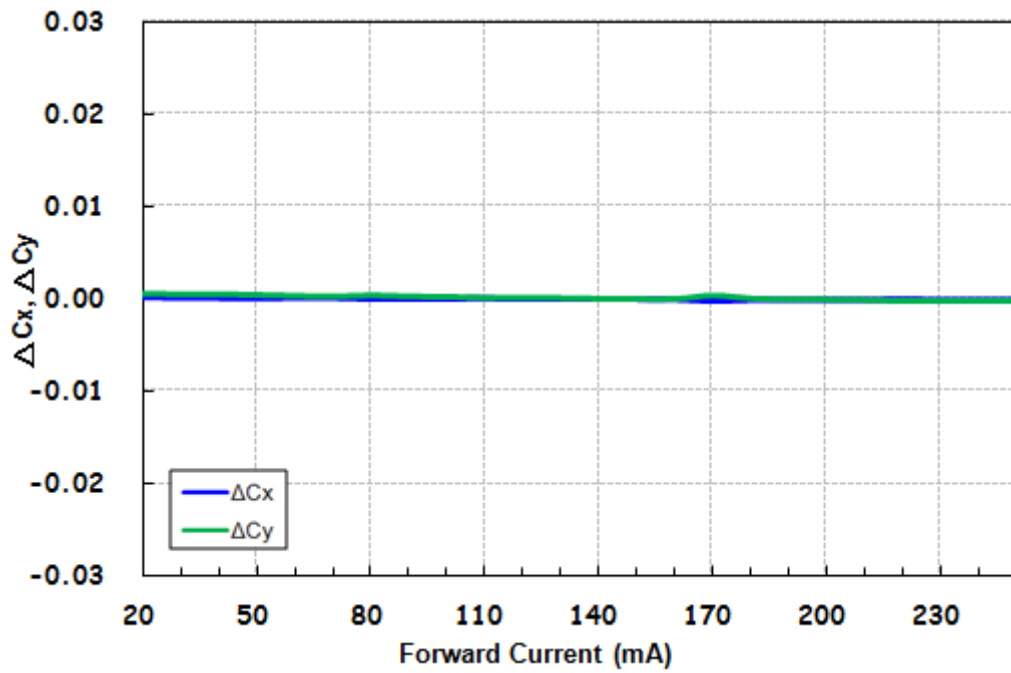

■ **Soldering Temperature vs. Relative Luminance, $I_F=140\text{mA}$**

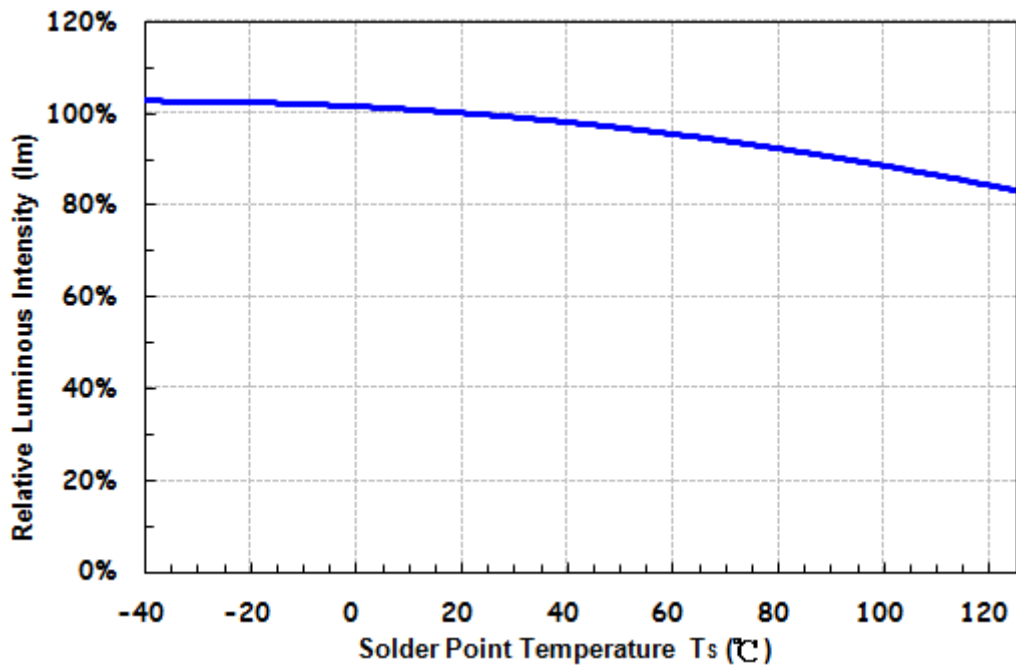

■ Soldering Temperature vs. Forward Voltage Shift, $I_F=140\text{mA}$

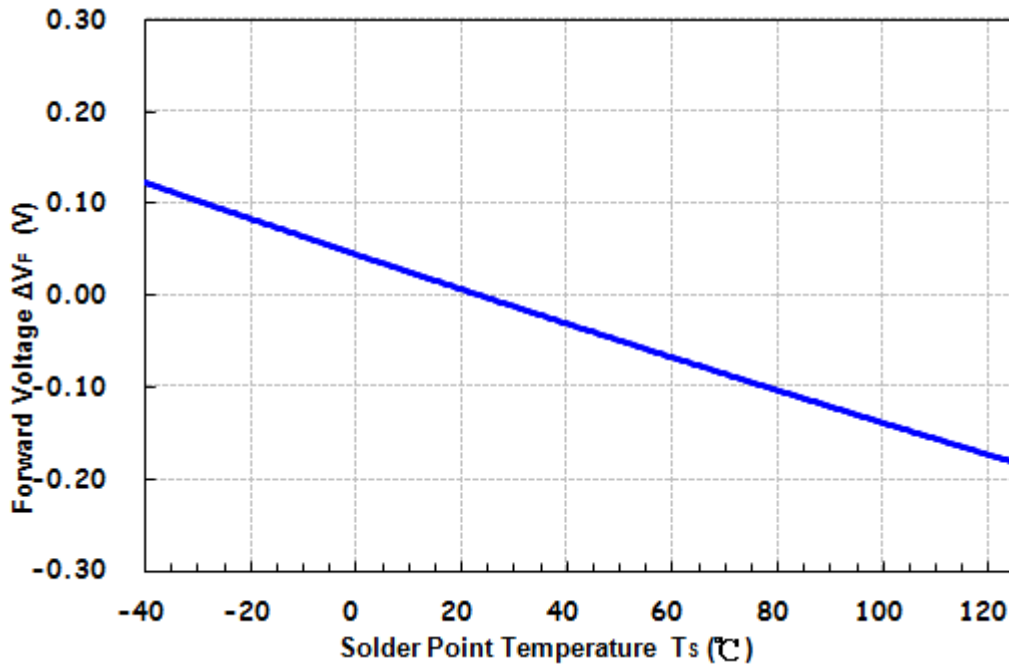

■ Chromaticity Coordinate vs. Soldering Temperature, $I_F=140\text{mA}$

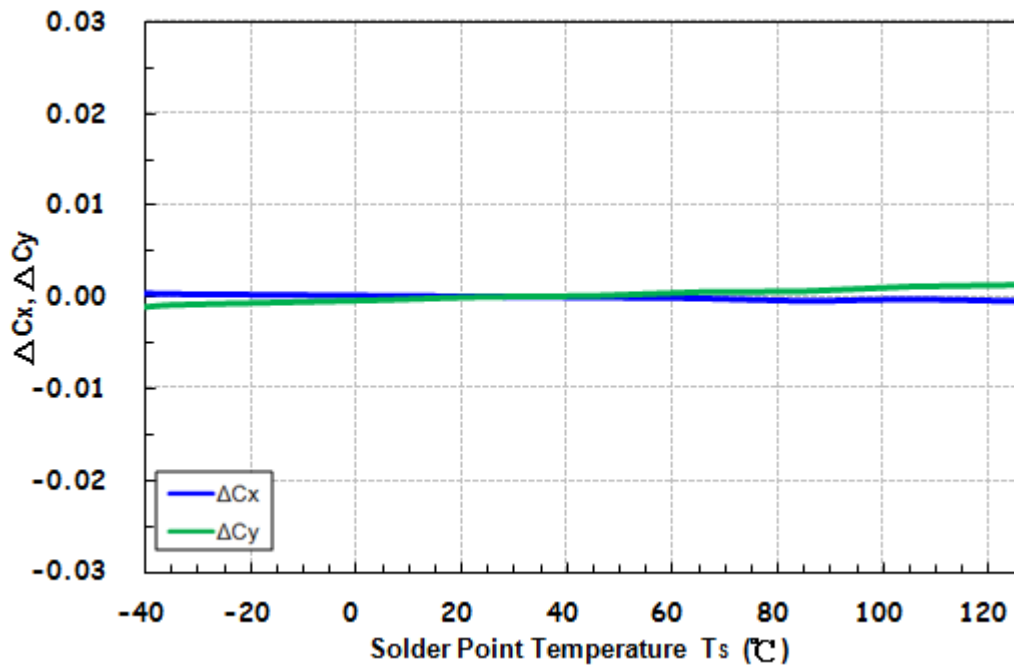

■ De-rating Curve

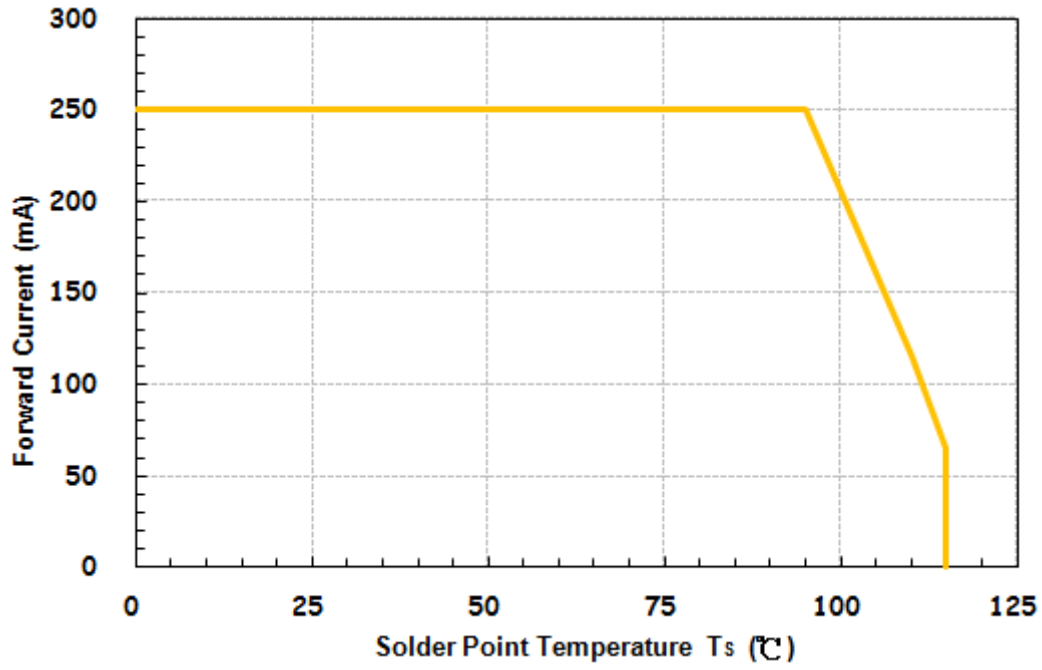

Reliability

PC35A25

Product Specification

Reliability test

	Item	Reference Standard	Condition	Time/Cycle
1	Thermal shock	JESD22-A106	-40°C to 100 °C, 20 mins dwell, 5 min transfer time	1000 Cycles
2	Temperature Cycle	AEC-Q101 Rev. D	-45°C to 125 °C 15 mins dwell at each high and low temperature extreme	1000 cycles
3	Power and Temperature Cycle	AEC-Q101 Rev. D	-40 °C~ 85 °C, IF=250mA, Dwell/transfer time = 10 mins, 20 mins 1,000 cycles , on/off 15,000 cycles	15,000 cycles
4	MSL Level 2	J-STD-020	85°C / 60% RH	168 hours
5	High Temperature Storage	JESD22-A103	TA=105°C, 1000h	1000 hours
6	Low Temperature Storage	JESD22-A119	TA=-40°C, 1000h	1000 hours
7	High Temperature Operating Life	AEC-Q101 Rev. D	TA=105°C, IF=250mA	1000 hours
8	Low Temperature Operating Life	JESD22-A108	TA=-40°C, IF=250mA	1000 hours
9	Temperature Humidity Operating Life	AEC-Q101 Rev. D	85°C, RH=85%, 1000h, IF=250mA	1000 hours
10	Electrostatic Discharges	AEC-Q101 Rev. D	HBM 8 KV, 1.5KΩ, 100pF, 3 pulses, alternately positive or negative	

Item	Reference Standard	Condition	Time
Corrosion robustness:	IEC 60068-2-43	(H2S) [25°C / 75 %RH / 10 ppm H2S]	336 hours
	EN60068-2-60	[25 °C / 75 %RH / 200 ppb SO ₂ , 200 ppb NO ₂ ,10 ppb Cl ₂]	504 hours

Judgment Criteria

Item	Symbol	Test Condition	Judgment Criteria
Forward Voltage	V _f	140 mA	ΔV _f < 10 %
Luminous Flux	I _v	140 mA	ΔI _v < 20 %
Delta CIE	CIE-x ,CIE-y	140mA	Δx,y <0.01

Packing

PC35A25

Product Specification

Label



Carrier Taping

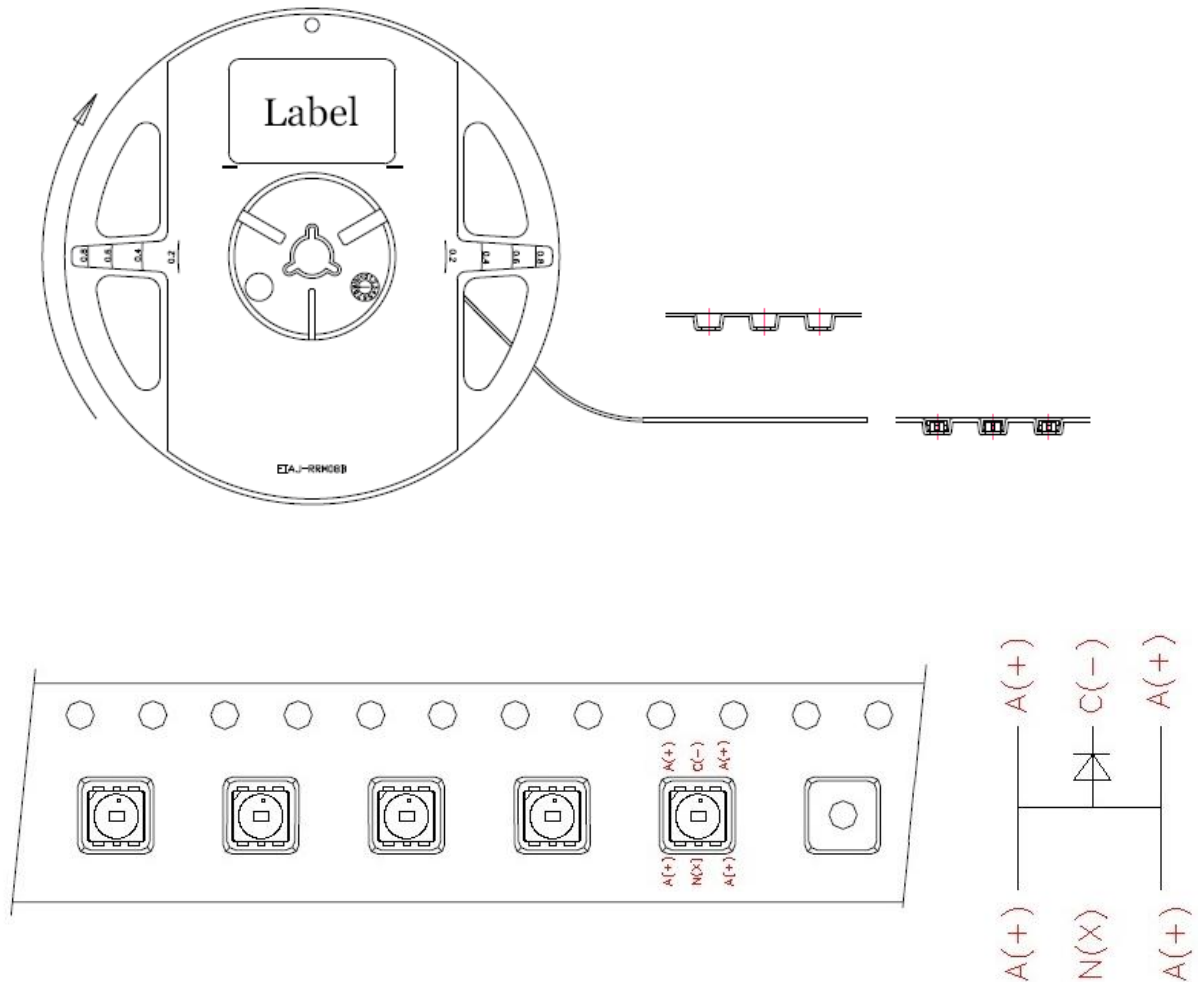

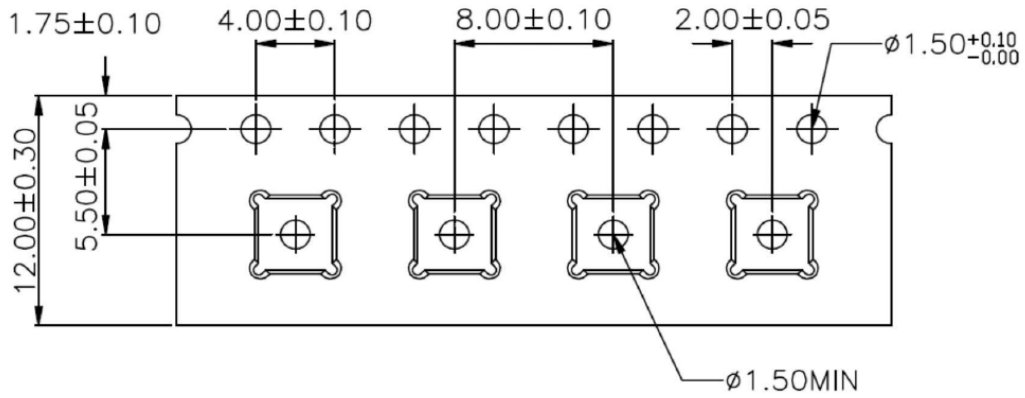

(Unit : mm)

■ Shield Bag Taping

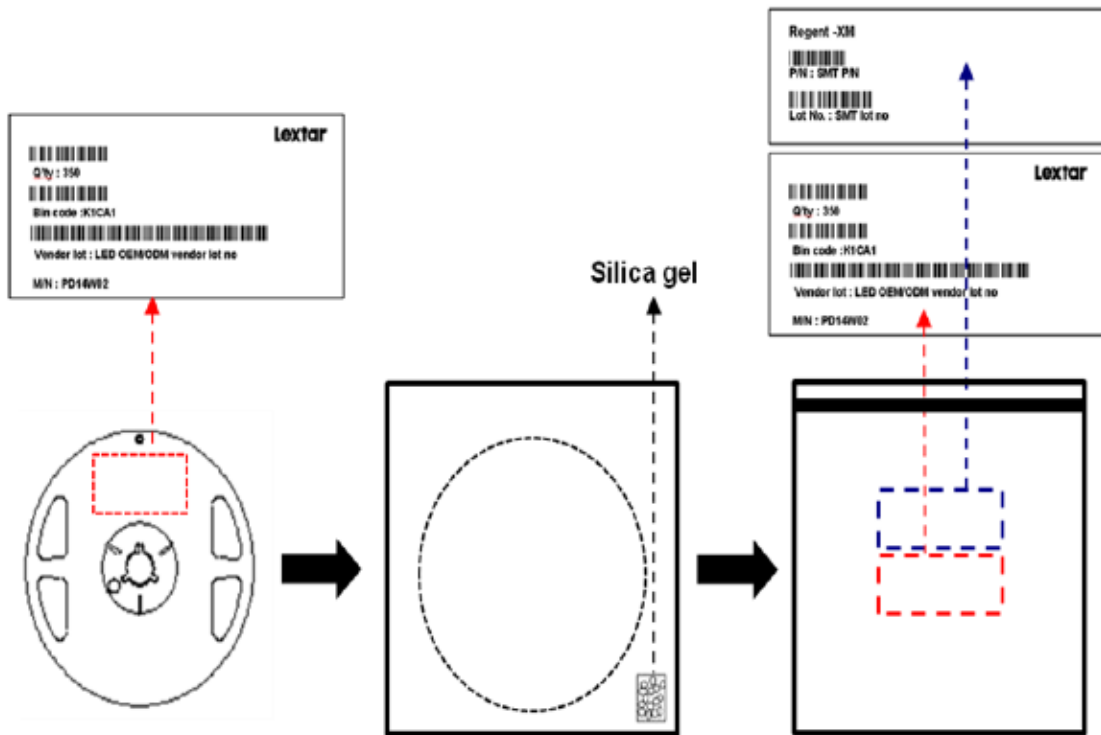

■ Packing Box

Type	Large Box		Medium Box		Small Box	
Dimension	541X511X276mm		385X303X260mm		283X235x70mm	
Maximum Reels	7"X12mm Reel	64/R	7"X12mm Reel	21/R	7"X12mm Reel	4/R
Minimum Reels	7"X12mm Reel	32/R	7"X12mm Reel	9/R	7"X12mm Reel	1/R

■ **Small Box**

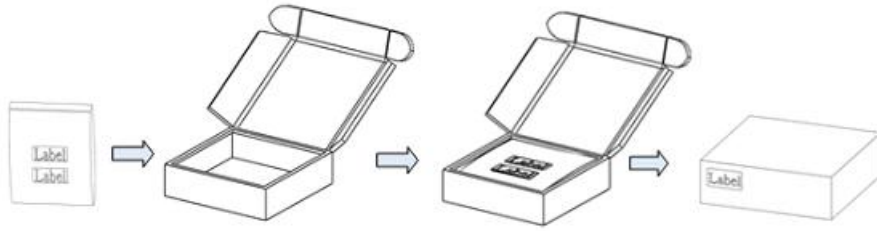

■ **Medium Box**

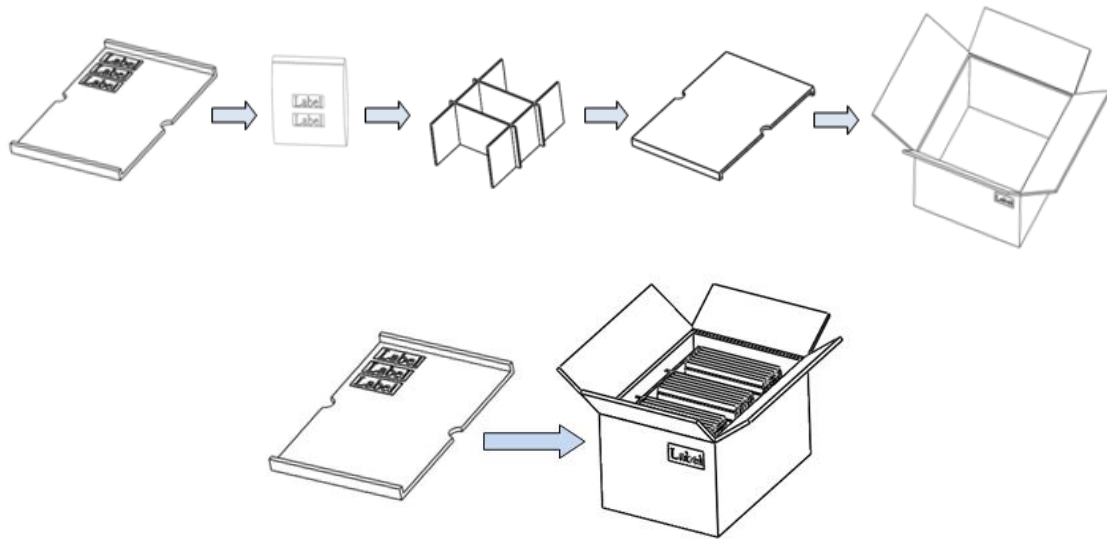

■ **Large Box**

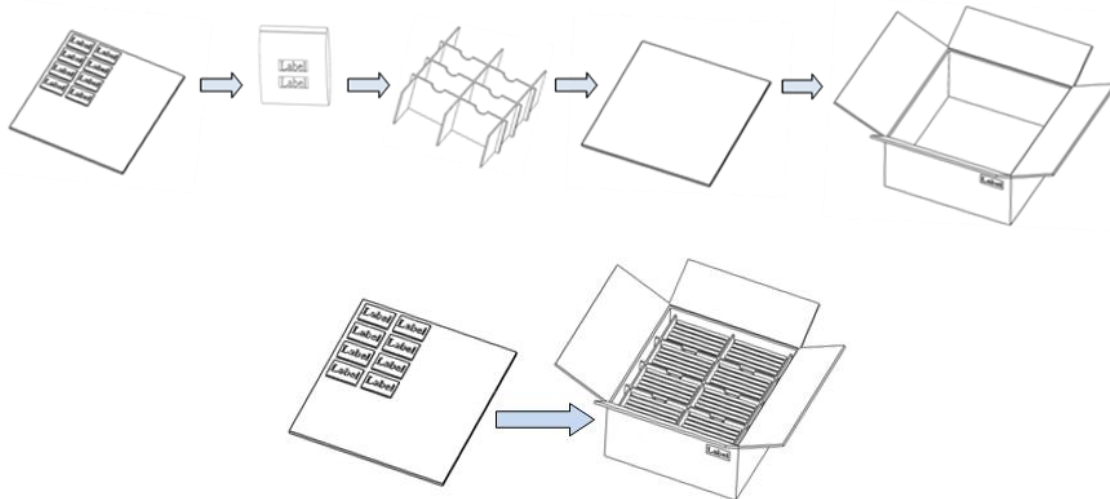

Precautions

PC35A25

Product Specification

■ Safety Precautions

- The LED light output is too strong for human eyes without shield. Prevent eye contact directly more than seconds.
- Ensure operating under maximum rating.

■ Storage

- Before opening the package, the LEDs should be kept at 40°C, 90% RH environment or less , and should be used within one year.
- After opening the package bag,
The LEDs should be kept at 30°C, 60% RH environment or less.
The LEDs should be soldered within 12 months (1 year).
If unused LEDs remain, they should be stored in moisture proof packages, such as sealed containers with packages of moisture absorbent material (silica gel).
- If the package is over storage time, the LEDs should be pre-bake 65 ± 5 °C / 12 hrs before use. (One time only).

■ Soldering Notice and Conditions

When soldering LEDs,

- Do not solder/reflow the same LED over two times.
- Reflow temperature profile as below: (lead-free solder)

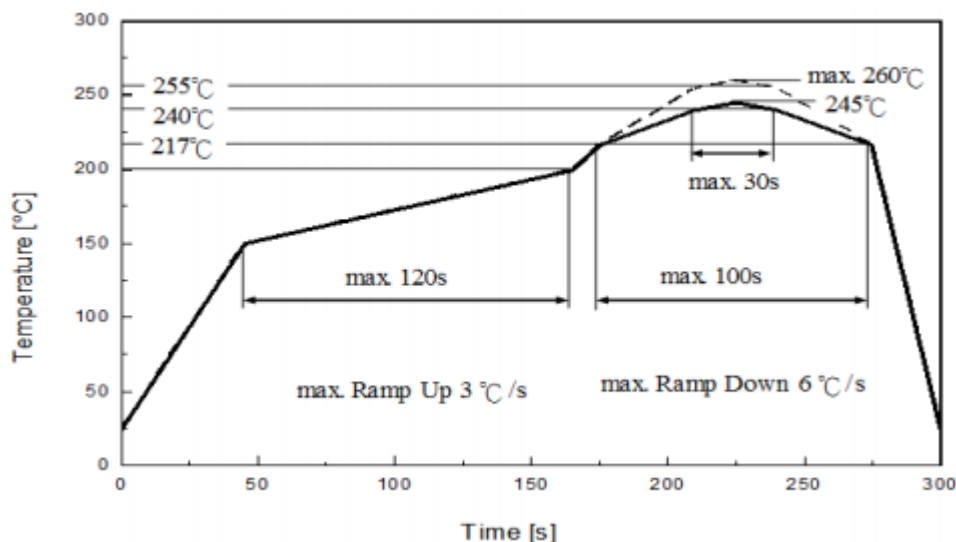

Classification Reflow Profile (JEDEC J-STD-020D)

- When soldering, don't put stress on the LEDs
- After LEDs have been soldered, strongly recommend not to repair to keep the LEDs performance.

■ Static Electricity

- LED package is extremely sensitive to static electricity. It's recommended that anti-electrostatic glove and wrist band is necessary when handling the LEDs. All devices are also be grounded properly as well.
- Protection devices design should be considered in the LED driving circuit.

■ Cleaning

- If washing is required, recommend to use alcohol as a solvent.
- Recommend to avoid cleaning the LEDs by ultrasonic. If necessary, pre-test the LED is necessary to confirm whether any damage occur after the process.

Revision History

PC33A25

Product Specification

Date	Contents	Writer	Approved
2017.02.20	Preliminary version	SK	Rex
2017.07.20	Update Carrier Taping	Kelly	Bemore
2017.08.07	1. Update Reliability test – P.10 2. Soldering Notice and Conditions – P.14	Kelly	Bemore
2017.09.11	Add Recommended Soldering Pad Polarity – P.3	Kelly	Bemore
2018.01.10	Add Rth – P.4	Kelly	Bemore
2018.07.11	Add De-rating curve – P.10 LED placed into carrier tape definition – P.12	Ray	Bemore
2018.12.25	Official version	Ray	Bemore
2020.02.14	Update carrier taping – P.13	Rick	Bemore
2021.07.19	Update Packing reel Q'ty – P.2	Rick	Bemore

Smart Lighting Amazing Life

Lextar Electronics Corp. is the leading LED (Light Emitting Diode) maker integrating upper stream epitaxial, middle stream chip, and downstream package, SMT and LED lighting applications. Founded in May, 2008, Lextar is a subsidiary of AU Optronics, the leading TFT-LCD and solar PV manufacturer. Lextar's product applications include lighting and LCD backlight. Lextar's manufacturing sites include Hsinchu and Chunan in Taiwan, and Suzhou in China. The company turnover in 2010 is 266 million USD.