



■ Features

- Constant Voltage + Constant Current mode output
- Wide input range 110-305VAC with PFC function
- Compliance with BS EN/EN61347 regulation
- Class 2/ II power unit (Except for 12V)
- Slim and Linear housing Design
- No load power consumption <0.5W
- 3 years warranty

■ Applications

- Panel lighting
- Strip lighting
- Decoration lighting
- Troffer lighting
- Signage and display
- Cove lighting

■ Description

SLD-80 series is a 80W AC/DC LED driver featuring the dual modes constant voltage and constant current output. SLD-80 operates from 110~305VAC and offers models with different rated voltage ranging between 12V and 56V. Thanks to the high efficiency up to 92%, with the fanless design, the entire series is able to operate for -20°C ~ +90°C case temperature under free air convection. SLD-80 design with low profile and linear housing which is good for signage and linear luminaire applications.

■ Model Encoding

SLD - 80 - 24

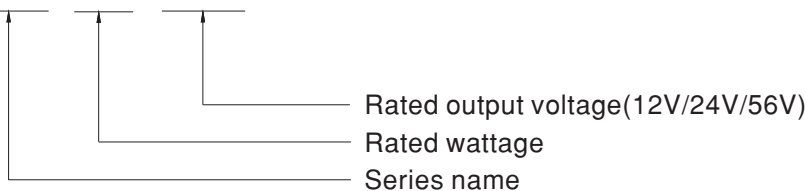

SPECIFICATION

| MODEL | SLD-80-12 | SLD-80-24 | | |
|---------------------------|--|---|---|-------------------|
| OUTPUT | DC VOLTAGE | 12V | 24V | |
| | CONSTANT CURRENT REGION <small>Note.2</small> | 8.4~12V | 16.8 ~24V | |
| | RATED CURRENT | 6.6A | 3.3A | |
| | RATED POWER <small>Note.5</small> | 79.2W | 79.2W | |
| | RIPPLE & NOISE (max.) <small>Note.3</small> | 150mVp-p | 240mVp-p | |
| | VOLTAGE TOLERANCE <small>Note.4</small> | ±4.0% | ±3.0% | |
| | LINE REGULATION | ±0.5% | ±0.5% | |
| | LOAD REGULATION | ±1.5% | ±0.5% | |
| | SETUP, RISE TIME <small>Note.6</small> | 500ms, 80ms 115VAC / 230VAC | | |
| HOLD UP TIME (Typ.) | 10ms/230VAC 10ms/115VAC | | | |
| INPUT | VOLTAGE RANGE <small>Note.5</small> | 110~ 305VAC 155~ 431VDC (Please refer to "STATIC CHARACTERISTIC" section) | | |
| | FREQUENCY RANGE | 47 ~ 63Hz | | |
| | POWER FACTOR | PF ≥ 0.97/115VAC, PF ≥ 0.95/230VAC, PF ≥ 0.92/277VAC@full load (Please refer to "POWER FACTOR (PF) CHARACTERISTIC" section) | | |
| | TOTAL HARMONIC DISTORTION | THD< 10%(@load≥60%/115VAC, 230VAC; @load≥75%/277VAC) (Please refer to "TOTAL HARMONIC DISTORTION(THD)" section) | | |
| | EFFICIENCY (Typ.) | 90.5% | 91.5% | |
| | AC CURRENT | 0.9A / 115VAC 0.45A / 230VAC 0.38A/277VAC | | |
| | INRUSH CURRENT(Typ.) | COLD START 50A(twidth=270μs measured at 50% Ipeak) at 230VAC; Per NEMA 410 | | |
| | MAX. No. of PSUs on 16A CIRCUIT BREAKER | 8 units (circuit breaker of type B) / 16 units (circuit breaker of type C) at 230VAC | | |
| | LEAKAGE CURRENT | <0.25mA / 277VAC | | |
| NO LOAD POWER CONSUMPTION | <0.5W | | | |
| PROTECTION | OVER CURRENT | 95 ~ 108% Constant current limiting or Hiccup mode, recovers automatically after fault condition is removed | | |
| | SHORT CIRCUIT | Hiccup mode, recovers automatically after fault condition is removed | | |
| | OVER VOLTAGE | 14 ~ 17V | 28 ~ 34V | |
| | OVER TEMPERATURE | Shut down output voltage, re-power on to recovery | | |
| ENVIRONMENT | WORKING TEMP. | Tcase=-20 ~ +90℃ (Please refer to " OUTPUT LOAD vs TEMPERATURE" section) | | |
| | MAX. CASE TEMP. | Tcase=+90℃ | | |
| | WORKING HUMIDITY | 20 ~ 95% RH non-condensing | | |
| | STORAGE TEMP. | -40 ~ +80℃ | | |
| | TEMP. COEFFICIENT | ±0.03%/℃ (0 ~ 50℃) | | |
| | VIBRATION | 10 ~ 500Hz, 2G 12min./1cycle, period for 72min. each along X, Y, Z axes | | |
| SAFETY & EMC | SAFETY STANDARDS <small>Note.8</small> | UL8750, CSA C22.2 No. 250.13-12, ENEC BS EN/EN61347-1, BS EN/EN61347-2-13 independent, BS EN/EN62384, EAC TP TC 004, GB19510.1, GB19510.14, IS15885(Part2/Sec13) approved | | |
| | WITHSTAND VOLTAGE | I/P-O/P:3.75KVAC | | |
| | ISOLATION RESISTANCE | I/P-O/P:100M Ohms / 500VDC / 25℃ / 70% RH | | |
| | EMC EMISSION <small>Note.8</small> | Parameter | Standard | Test Level/Note |
| | | Conducted | BS EN/EN55015(CISPR15) ,GB/T17743 | ----- |
| | | Radiated | BS EN/EN55015(CISPR15) ,GB/T17743 | ----- |
| | | Harmonic Current | BS EN/EN61000-3-2 ,GB/T17625.1 | Class C @load≥60% |
| | EMC IMMUNITY | Voltage Flicker | BS EN/EN61000-3-3 | ----- |
| | | BS EN/EN61547 | | |
| | | Parameter | Standard | Test Level/Note |
| ESD | | BS EN/EN61000-4-2 | Level 3, 8KV air ; Level 2, 4KV contact | |
| Radiated | | BS EN/EN61000-4-3 | Level 2 | |
| EFT/Burst | | BS EN/EN61000-4-4 | Level 2 | |
| Surge | | BS EN/EN61000-4-5 | 1KV/Line-Line | |
| OTHERS | MTBF | 867.33K hrs min. Telcordia SR-332 (Bellcore) ; 260.96K hrs min. MIL-HDBK-217F (25℃) | | |
| | DIMENSION | 320*30*16.8mm (L*W*H) | | |
| | PACKING | 0.206 Kg; 64pcs / 14.184Kg / 0.75CUFT | | |
| NOTE | 1. All parameters NOT specially mentioned are measured at 230VAC input, rated current and 25℃ of ambient temperature. 2. Please refer to "DRIVING METHODS OF LED MODULE". 3. Ripple & noise are measured at 20MHz of bandwidth by using a 12" twisted pair-wire terminated with a 0.1uf & 47uf parallel capacitor. 4. Tolerance : includes set up tolerance, line regulation and load regulation. 5. De-rating may be needed under low input voltages. Please refer to "STATIC CHARACTERISTIC" sections for details. 6. Length of set up time is measured at first cold start. Turning ON/OFF the driver may lead to increase of the set up time. 7. The driver is considered as a component that will be operated in combination with final equipment. Since EMC performance will be affected by the complete installation, the final equipment manufacturers must re-qualify EMC Directive on the complete installation again. 8. This series meets the typical life expectancy of 30000 hours of operation when Tcase, particularly (Tc) point (or TMP, per DLC), is about 75℃ or less. 9. Please refer to the warranty statement on MEAN WELL's website at http://www.meanwell.com 10. The ambient temperature derating of 3.5℃/1000m with fanless models and of 5℃/1000m with fan models for operating altitude higher than 2000m(6500ft). ※ Product Liability Disclaimer : For detailed information, please refer to https://www.meanwell.com/serviceDisclaimer.aspx | | | |

SPECIFICATION

| | | | | | |
|-------------------------|--|---|--|---|--|
| MODEL | | SLD-80-56 | | | |
| OUTPUT | RATED CURRENT | 1400mA | | | |
| | RATED POWER <small>Note.2</small> | 78.4W | | | |
| | CONSTANT CURRENT REGION <small>Note.3</small> | 30 ~56V | | | |
| | FULL POWER CURRENT RANGE | 1400~2100mA | | | |
| | OPEN CIRCUIT VOLTAGE (max.) | 60V | | | |
| | CURRENT ADJ. RANGE | 700~2100mA | | | |
| | CURRENT RIPPLE | 5.0%(@rated current) | | | |
| | CURRENT TOLERANCE | ±5% | | | |
| | SET UP TIME <small>Note.5</small> | 500ms/230VAC, 1200ms/115VAC | | | |
| INPUT | VOLTAGE RANGE <small>Note.2</small> | 110 ~ 305VAC 155VDC ~ 431VDC (Please refer to "STATIC CHARACTERISTIC" and "DRIVING METHODS OF LED MODULE" section) | | | |
| | FREQUENCY RANGE | 47 ~ 63Hz | | | |
| | POWER FACTOR (Typ.) | PF ≥ 0.97 / 115VAC, PF ≥ 0.95 / 230VAC, PF ≥ 0.92 / 277VAC at full load (Please refer to "Power Factor Characteristic" section) | | | |
| | TOTAL HARMONIC DISTORTION | THD < 10% (@ load ≥ 60% at 115VAC/230VAC, @load ≥ 75% at 277VAC) Please refer to "TOTAL HARMONIC DISTORTION (THD)" section | | | |
| | EFFICIENCY (Typ.) | 92.0% | | | |
| | AC CURRENT (Typ.) | 0.9A / 115VAC 0.45A / 230VAC 0.38A / 277VAC | | | |
| | INRUSH CURRENT(Typ.) | COLD START 50A(twidth=270µs measured at 50% I _{peak}) at 230VAC; Per NEMA 410 | | | |
| | MAX. NO. of PSUs on 16A CIRCUIT BREAKER | 8 unit(circuit breaker of type B) / 16 units(circuit breaker of type C) at 230VAC | | | |
| | LEAKAGE CURRENT | <0.25mA / 277VAC | | | |
| | NO LOAD POWER CONSUMPTION | <0.5W | | | |
| PROTECTION | OVER POWER | 110 ~ 150% Hiccup mode, recovers automatically after fault condition is removed | | | |
| | SHORT CIRCUIT | Hiccup mode, recovers automatically after fault condition is removed | | | |
| | OVER VOLTAGE | 60 ~ 70V Shut down output voltage, re-power on to recovery | | | |
| | OVER TEMPERATURE | Shut down output voltage, re-power on to recovery | | | |
| ENVIRONMENT | WORKING TEMP. | T _{case} = -20 ~ +90°C (Please refer to "OUTPUT LOAD vs TEMPERATURE" section) | | | |
| | MAX. CASE TEMP. | T _{case} = +90°C | | | |
| | WORKING HUMIDITY | 20 ~ 95% RH non-condensing | | | |
| | STORAGE TEMP. | -40 ~ +80°C | | | |
| | TEMP. COEFFICIENT | ±0.03%/°C (0 ~ 60°C) | | | |
| | VIBRATION | 10 ~ 500Hz, 2G 12min./1cycle, period for 72min. each along X, Y, Z axes | | | |
| SAFETY & EMC | SAFETY STANDARDS <small>Note.4</small> | UL8750, CSA C22.2 No. 250.13-12, ENEC BS EN/EN61347-1, BS EN/EN61347-2-13 independent, BS EN/EN62384, EAC TP TC 004, GB19510.1, GB19510.14, IS15885(Part2/Sec13) approved | | | |
| | WITHSTAND VOLTAGE | I/P-O/P:3.75KVAC | | | |
| | ISOLATION RESISTANCE | I/P-O/P:100M Ohms / 500VDC / 25°C / 70% RH | | | |
| | EMC EMISSION <small>Note.4</small> | Parameter | Standard | Test Level/Note | |
| | | Conducted | BS EN/EN55015(CISPR15), GB/T17743 | ----- | |
| | | Radiated | BS EN/EN55015(CISPR15), GB/T17743 | ----- | |
| | | Harmonic Current | BS EN/EN61000-3-2, GB/T17625.1 | Class C @load ≥ 60% | |
| | | Voltage Flicker | BS EN/EN61000-3-3 | ----- | |
| | EMC IMMUNITY | BS EN/EN61547 | | | |
| | | Parameter | Standard | Test Level/Note | |
| | | ESD | BS EN/EN61000-4-2 | Level 3, 8KV air ; Level 2, 4KV contact | |
| | | Radiated | BS EN/EN61000-4-3 | Level 2 | |
| | | EFT/Burst | BS EN/EN61000-4-4 | Level 2 | |
| Surge | | BS EN/EN61000-4-5 | 1KV/Line-Line | | |
| Conducted | | BS EN/EN61000-4-6 | Level 2 | | |
| Magnetic Field | | BS EN/EN61000-4-8 | Level 2 | | |
| | Voltage Dips and Interruptions | BS EN/EN61000-4-11 | >95% dip 0.5 periods, 30% dip 25 periods, >95% interruptions 250 periods | | |
| OTHERS | MTBF | 867.33K hrs min. Telcordia SR-332 (Bellcore); 260.96K hrs min. MIL-HDBK-217F (25°C) | | | |
| | DIMENSION | 320*30*16.8mm (L*W*H) | | | |
| | PACKING | 0.206 Kg; 64pcs / 14.184Kg / 0.75CUFT | | | |
| NOTE | <ol style="list-style-type: none"> All parameters NOT specially mentioned are measured at 230VAC input, rated current and 25°C of ambient temperature. De-rating may be needed under low input voltages. Please refer to "STATIC CHARACTERISTIC" sections for details. Please refer to "DRIVING METHODS OF LED MODULE". This series meets the typical life expectancy of 30000 hours of operation when T_{case}, particularly (T_c) point (or TMP, per DLC), is about 75°C or less. Length of set up time is measured at first cold start. Turning ON/OFF the driver may lead to increase of the set up time. The driver is considered as a component that will be operated in combination with final equipment. Since EMC performance will be affected by the complete installation, the final equipment manufacturers must re-qualify EMC Directive on the complete installation again. Ripple & noise are measured at 20MHz of bandwidth by using a 12" twisted pair-wire terminated with a 0.1µf & 47µf parallel capacitor. Please refer to the warranty statement on MEAN WELL's website at http://www.meanwell.com The ambient temperature derating of 3.5°C/1000m with fanless models and of 5°C/1000m with fan models for operating altitude higher than 2000m(6500ft). <p>⊗ Product Liability Disclaimer : For detailed information, please refer to https://www.meanwell.com/serviceDisclaimer.aspx</p> | | | | |

■ BLOCK DIAGRAM

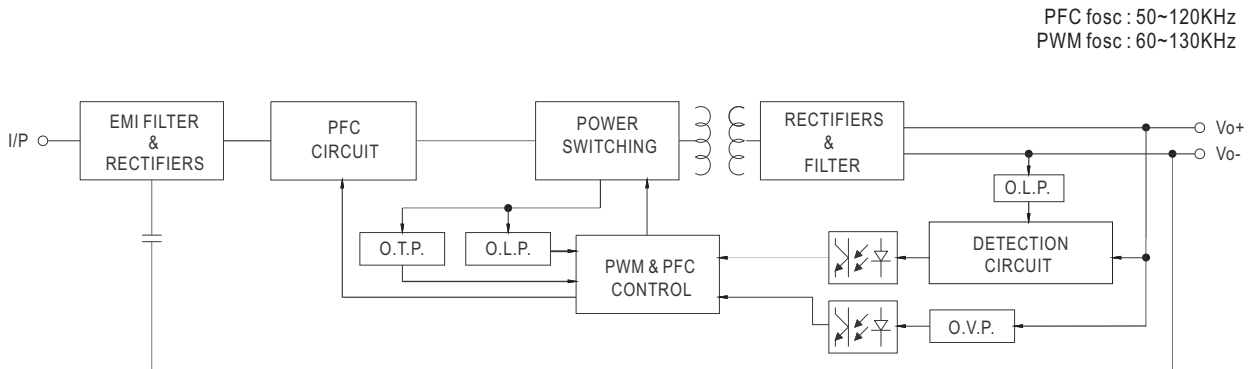

■ DRIVING METHODS OF LED MODULE

◎ SLD-80-12,24

※ This series is able to work in either Constant Current mode (a direct drive way) or Constant Voltage mode (usually through additional DC/DC driver) to drive the LEDs.

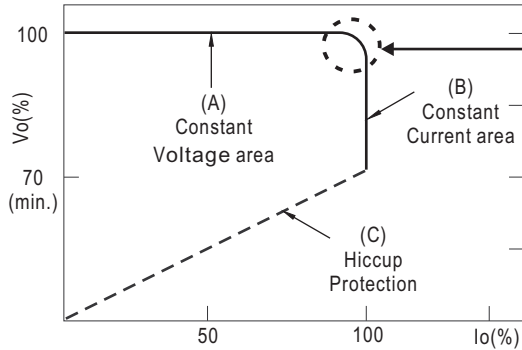

Typical output current normalized by rated current (%)

In the constant current region, the highest voltage at the output of the driver depends on the configuration of the end systems.
Should there be any compatibility issues, please contact MEAN WELL.

◎ SLD-80-56

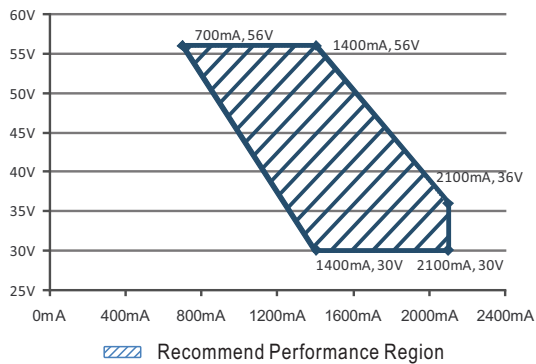

OUTPUT LOAD vs TEMPERATURE

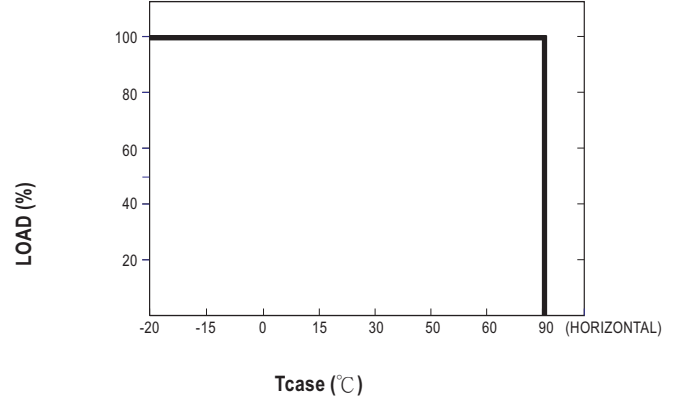
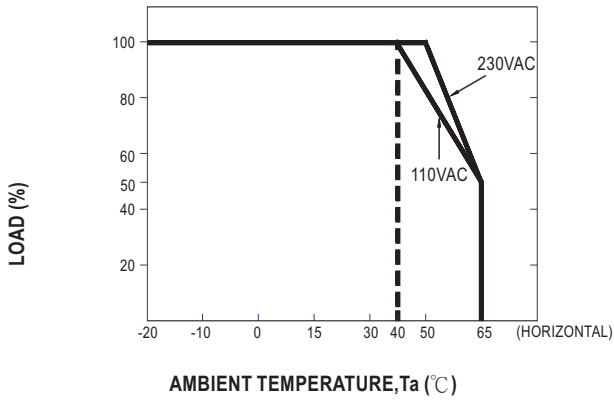

STATIC CHARACTERISTIC

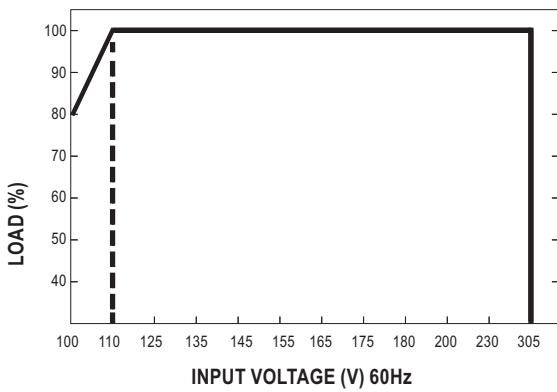

※ De-rating is needed under low input voltage.

POWER FACTOR (PF) CHARACTERISTIC

※ 24V Model, Tcase at 75°C

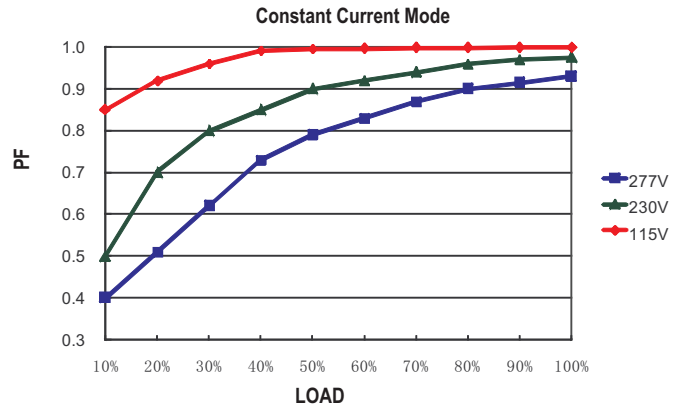

TOTAL HARMONIC DISTORTION (THD)

※ 24V Model, Tcase at 75°C

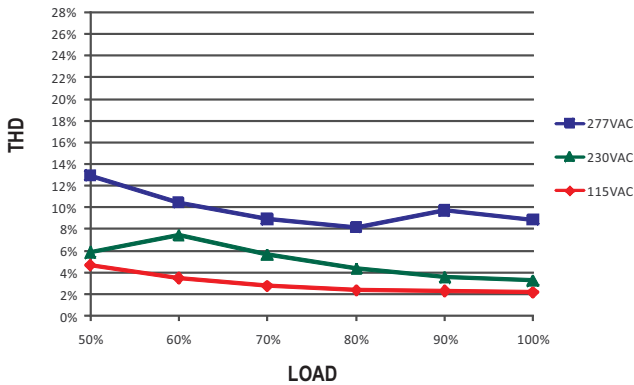

EFFICIENCY vs LOAD

SLD-80 series possess superior working efficiency that up to 91.5% can be reached in field applications.

※ 24V Model, Tcase at 75°C

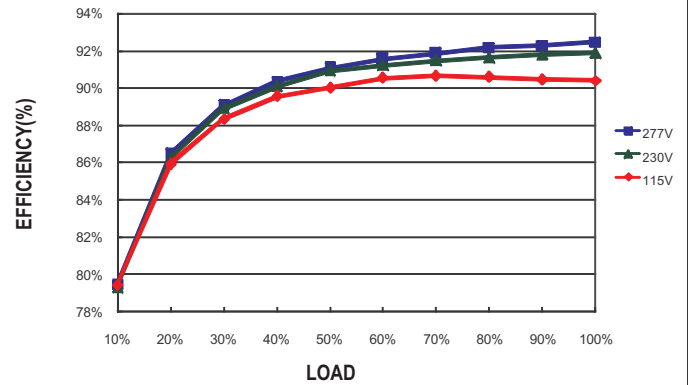

■ LIFE TIME

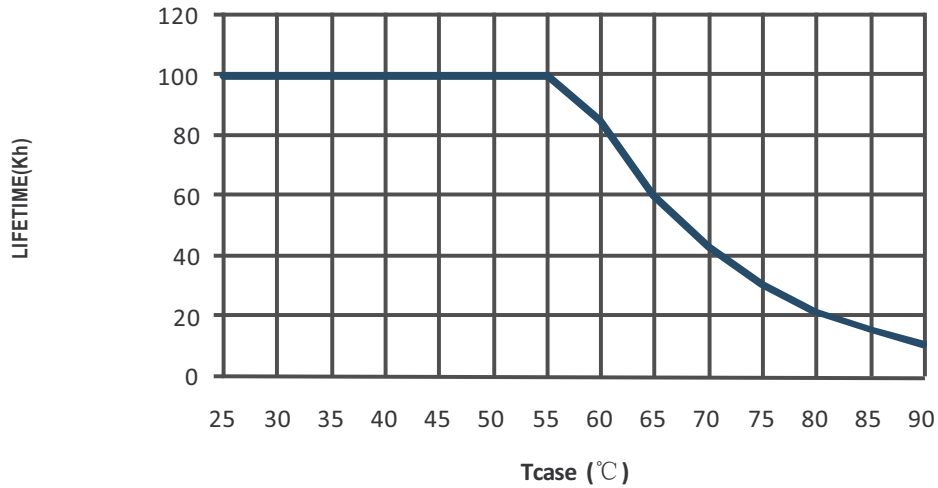

■ Mechanical Specification

Unit:mm

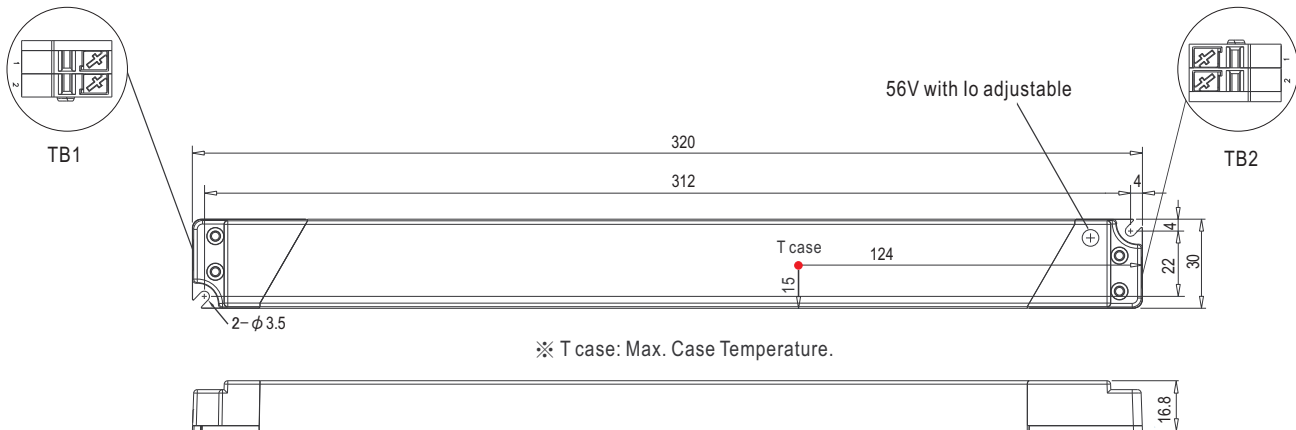

TB1 wiring:

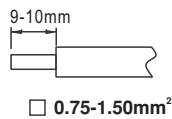

Terminal Pin No. Assignment (TB1) :
DEGSON DG219-3.5(GRAY)

| Pin No. | Assignment |
|---------|------------|
| 1 | AC/L |
| 2 | AC/N |

TB2 wiring:

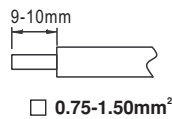

Terminal Pin No. Assignment (TB2) :
DEGSON DG219-3.5(RED/BLACK)

| Pin No. | Assignment |
|---------|------------|
| 1 | +V |
| 2 | -V |

■ INSTALLATION MANUAL

Please refer to : <http://www.meanwell.com/manual.html>