

HEIDI-SS

~15° smooth spot beam

TECHNICAL SPECIFICATIONS:

Dimensions	Ø 21.6 mm
Height	11.7 mm
Fastening	tape, pin
ROHS compliant	yes ⓘ

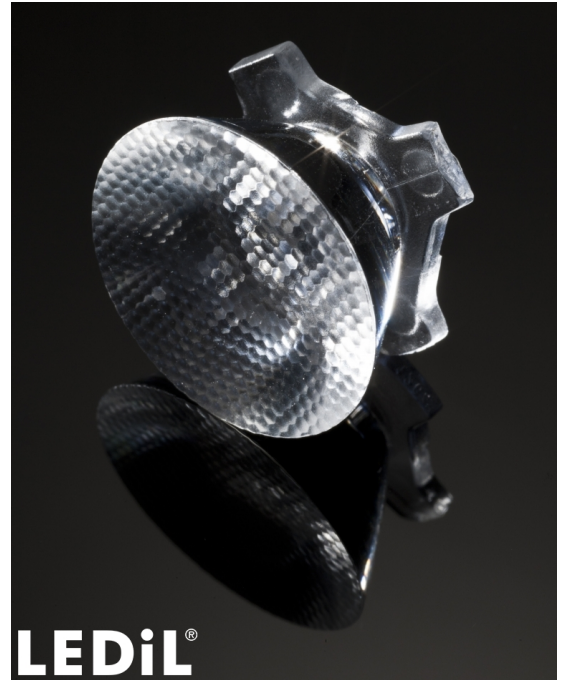

MATERIAL SPECIFICATIONS:

Component	Type	Material	Colour	Finish
HEIDI-SS	Single lens	PMMA	clear	
HEIDI-TAPE	Tape	Acrylic foam	black	





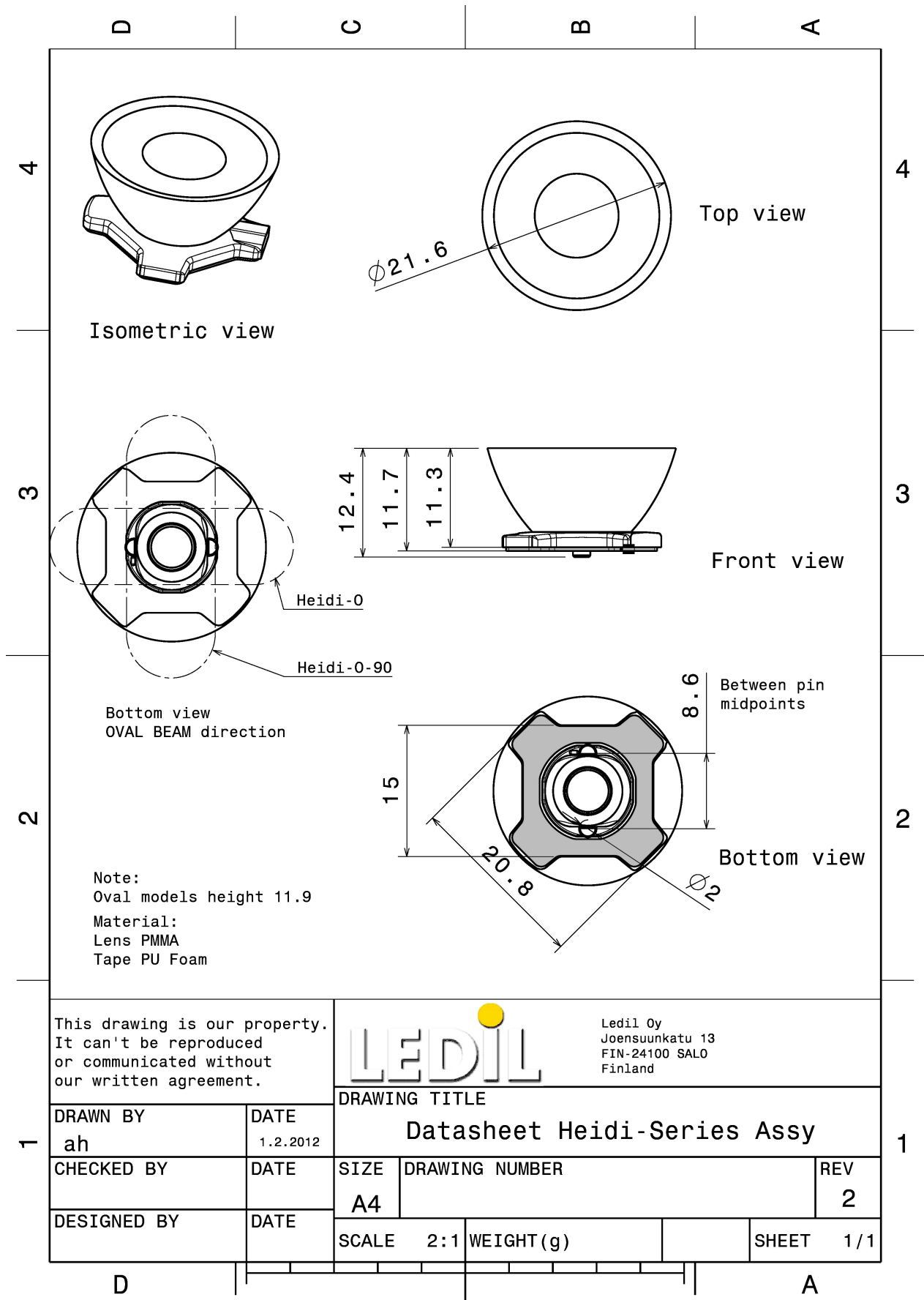

ORDERING INFORMATION:

Component		Qty in box	MOQ	MPQ	Box weight (kg)
CA12242_HEIDI-SS	Single lens	3264	204	204	11.1
» Box size: 480 x 280 x 300 mm					

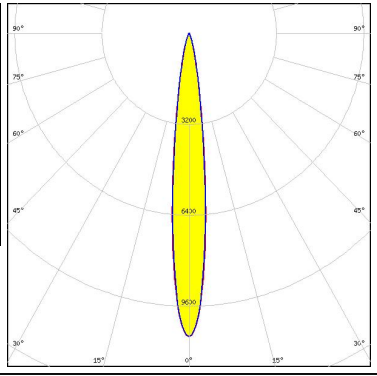

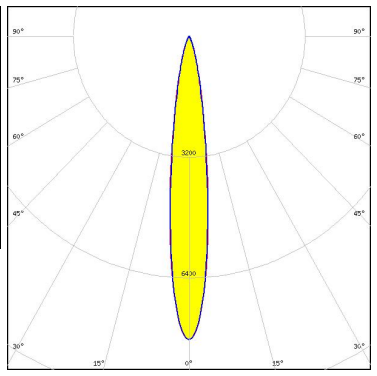
See also our general installation guide: www.ledil.com/installation_guide

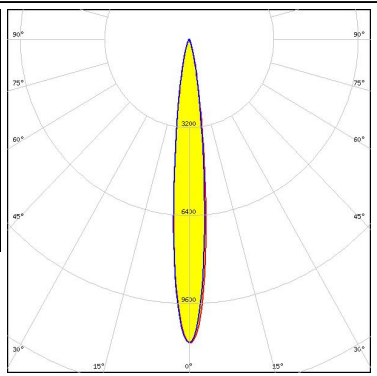
PHOTOMETRIC DATA (MEASURED):

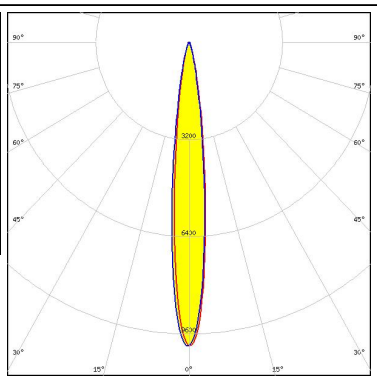
<p>CREE ⇄ LED</p> <p>LED XP-E FWHM / FWTM 13.0° / 28.0° Efficiency 95 % Peak intensity 10.7 cd/lm LEDs/each optic 1 Light colour White Required components:</p>		
<p>CREE ⇄ LED</p> <p>LED XP-G FWHM / FWTM 15.0° / 33.0° Efficiency 95 % Peak intensity 8 cd/lm LEDs/each optic 1 Light colour White Required components:</p>		
<p>CREE ⇄ LED</p> <p>LED XQ-E HD FWHM / FWTM 12.0° / 27.0° Efficiency 94 % Peak intensity 11.1 cd/lm LEDs/each optic 1 Light colour White Required components:</p>		
<p>CREE ⇄ LED</p> <p>LED XQ-E HI FWHM / FWTM 12.0° / 28.0° Efficiency 92 % Peak intensity 10 cd/lm LEDs/each optic 1 Light colour White Required components:</p>		

PHOTOMETRIC DATA (MEASURED):

LUMILEDS

LED LUXEON C
 FWHM / FWTM 13.0° / 28.0°
 Efficiency 87 %
 Peak intensity 9.8 cd/m
 LEDs/each optic 1
 Light colour White
 Required components:

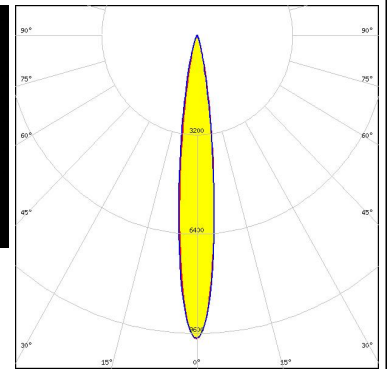
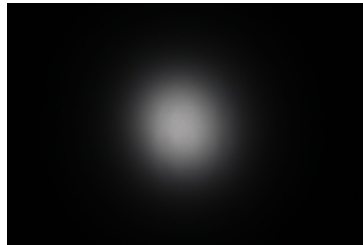

LUMILEDS

LED LUXEON T
 FWHM / FWTM 15.0° / 33.0°
 Efficiency 87 %
 Peak intensity 7.3 cd/m
 LEDs/each optic 1
 Light colour White
 Required components:

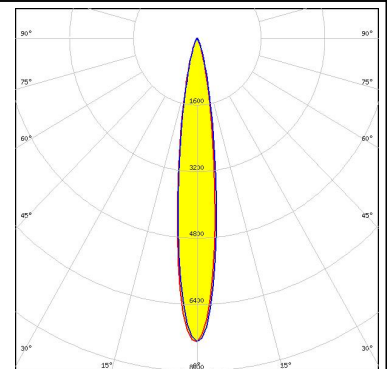

LUMILEDS

LED LUXEON TX
 FWHM / FWTM 16.0° / 34.0°
 Efficiency 86 %
 Peak intensity 7.8 cd/m
 LEDs/each optic 1
 Light colour White
 Required components:

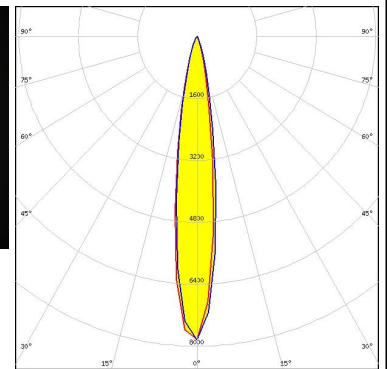
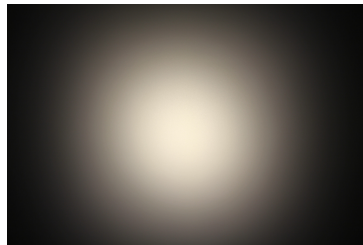

NICHIA

LED NCSxx19A
 FWHM / FWTM 14.0° / 31.0°
 Efficiency 95 %
 Peak intensity 8.8 cd/m
 LEDs/each optic 1
 Light colour White
 Required components:

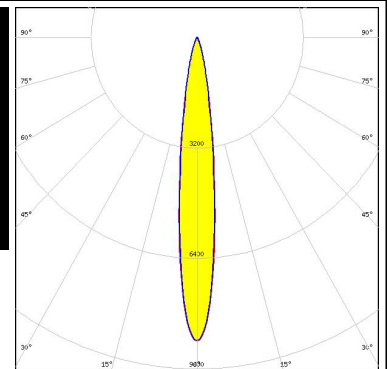

PHOTOMETRIC DATA (MEASURED):



LED NCSxx19B
 FWHM / FWTM 15.0° / 32.0°
 Efficiency 86 %
 Peak intensity 8.5 cd/lm
 LEDs/each optic 1
 Light colour White
 Required components:

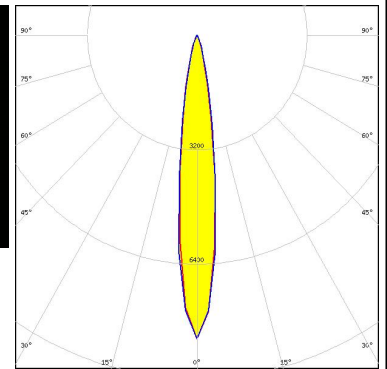
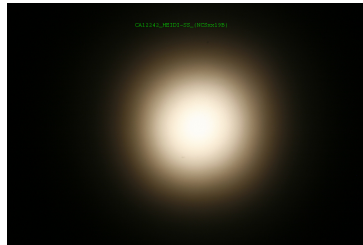

LED NVSxx19A
 FWHM / FWTM 15.0° / 34.0°
 Efficiency 95 %
 Peak intensity 7.3 cd/lm
 LEDs/each optic 1
 Light colour White
 Required components:

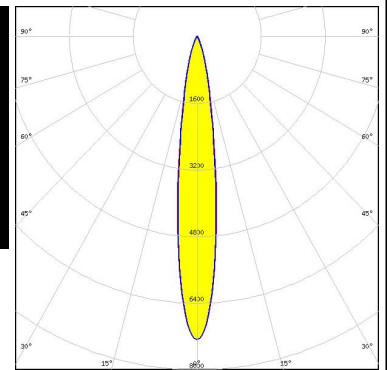



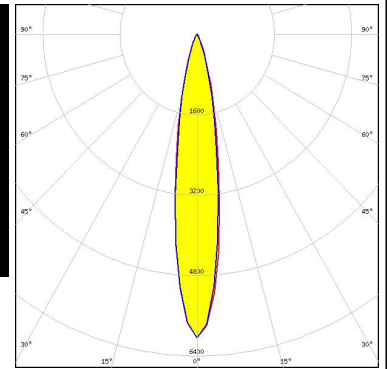

LED NVSxx19B/NVSxx19C
 FWHM / FWTM 18.0° / 38.0°
 Efficiency 87 %
 Peak intensity 6 cd/lm
 LEDs/each optic 1
 Light colour White
 Required components:

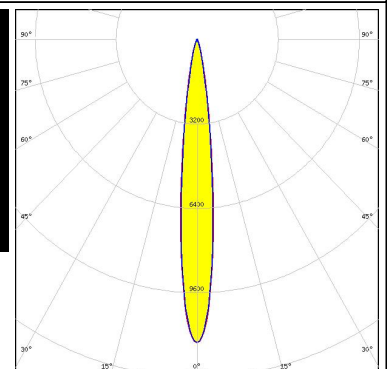

LED OSLON SSL 150
 FWHM / FWTM 13.0° / 26.0°
 Efficiency 96 %
 Peak intensity 11.5 cd/lm
 LEDs/each optic 1
 Light colour White
 Required components:

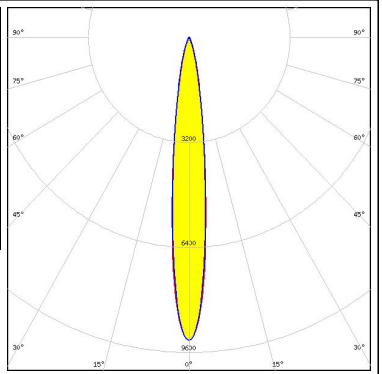

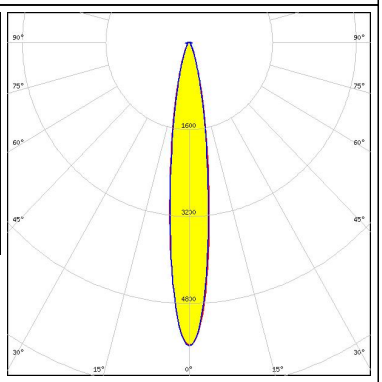
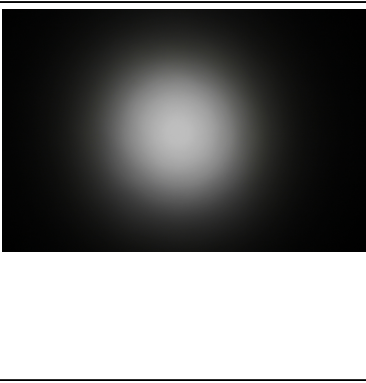
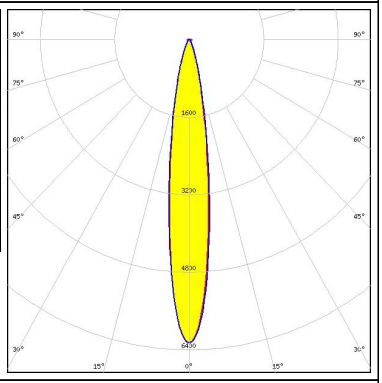
PHOTOMETRIC DATA (MEASURED):

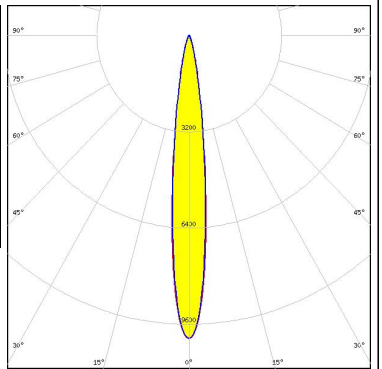
<p>OSRAM Opto Semiconductors</p> <p>LED OSLON SSL 80</p> <p>FWHM / FWTM 13.0° / 30.0°</p> <p>Efficiency 95 %</p> <p>Peak intensity 9.3 cd/lm</p> <p>LEDs/each optic 1</p> <p>Light colour White</p> <p>Required components:</p>		
<p>SAMSUNG</p> <p>LED LH181A</p> <p>FWHM / FWTM 15.0° / 36.0°</p> <p>Efficiency 88 %</p> <p>Peak intensity 5.6 cd/lm</p> <p>LEDs/each optic 1</p> <p>Light colour White</p> <p>Required components:</p>		
<p>SAMSUNG</p> <p>LED LH181B</p> <p>FWHM / FWTM 15.0° / 36.0°</p> <p>Efficiency 93 %</p> <p>Peak intensity 6.3 cd/lm</p> <p>LEDs/each optic 1</p> <p>Light colour White</p> <p>Required components:</p>		
<p>SEOUL SEOUL SEMICONDUCTOR</p> <p>LED Z5</p> <p>FWHM / FWTM 13.0° / 28.0°</p> <p>Efficiency 95 %</p> <p>Peak intensity 10.1 cd/lm</p> <p>LEDs/each optic 1</p> <p>Light colour White</p> <p>Required components:</p>		

PHOTOMETRIC DATA (MEASURED):

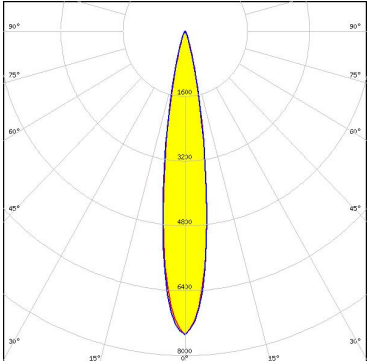
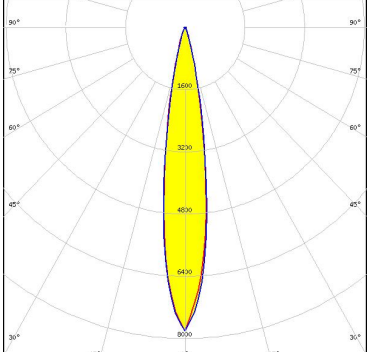
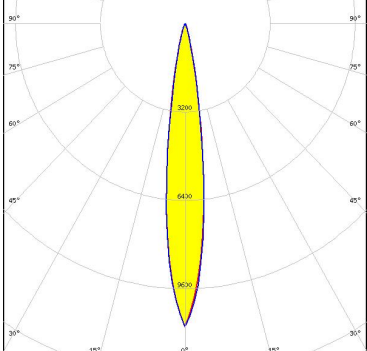
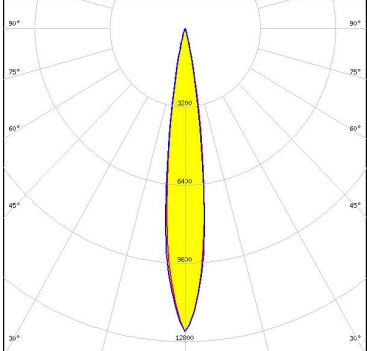

PHOTOMETRIC DATA (SIMULATED):

<p>CREE LED</p> <p>LED: XP-G2 HE FWHM / FWTM: 16.0° / 32.0° Efficiency: 94 % Peak intensity: 7.5 cd/lm LEDs/each optic: 1 Light colour: White Required components:</p>	
<p>CREE LED</p> <p>LED: XP-G3 FWHM / FWTM: 17.0° / 32.0° Efficiency: 94 % Peak intensity: 7.8 cd/lm LEDs/each optic: 1 Light colour: White Required components:</p>	
<p>LUMILEDS</p> <p>LED: LUXEON 3030 HE Plus FWHM / FWTM: 14.0° / 28.0° Efficiency: 95 % Peak intensity: 11 cd/lm LEDs/each optic: 1 Light colour: White Required components:</p>	
<p>LUMILEDS</p> <p>LED: LUXEON SunPlus 20 Line (120 deg) FWHM / FWTM: 14.0° / 26.0° Efficiency: 96 % Peak intensity: 12.4 cd/lm LEDs/each optic: 1 Light colour: White Required components:</p>	

PHOTOMETRIC DATA (SIMULATED):

<p>LUMILEDS</p> <p>LED LUXEON SunPlus 20 Line (150 deg)</p> <p>FWHM / FWTM 14.0° / 26.0°</p> <p>Efficiency 92 %</p> <p>Peak intensity 12.3 cd/lm</p> <p>LEDs/each optic 1</p> <p>Light colour White</p> <p>Required components:</p>	
<p>LUMILEDS</p> <p>LED LUXEON Z ES</p> <p>FWHM / FWTM 13.0° / 24.0°</p> <p>Efficiency 94 %</p> <p>Peak intensity 14.9 cd/lm</p> <p>LEDs/each optic 1</p> <p>Light colour White</p> <p>Required components:</p>	
<p>NICHIA</p> <p>LED NVSxE21A</p> <p>FWHM / FWTM 14.0° / 28.0°</p> <p>Efficiency 95 %</p> <p>Peak intensity 10.8 cd/lm</p> <p>LEDs/each optic 1</p> <p>Light colour White</p> <p>Required components:</p>	
<p>OSRAM Opto Semiconductors</p> <p>LED OSCONIQ S 3030</p> <p>FWHM / FWTM 15.0° / 28.0°</p> <p>Efficiency 95 %</p> <p>Peak intensity 11.2 cd/lm</p> <p>LEDs/each optic 1</p> <p>Light colour White</p> <p>Required components:</p>	

PHOTOMETRIC DATA (SIMULATED):

OSRAM Opto Semiconductors

LED OSLON Square CSSRM2/CSSRM3
 FWHM / FWTM 17.0° / 33.0°
 Efficiency 94 %
 Peak intensity 8.3 cd/lm
 LEDs/each optic 1
 Light colour White
 Required components:

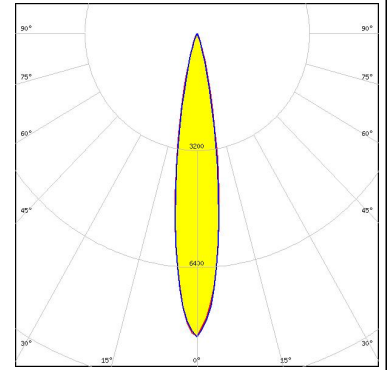

OSRAM Opto Semiconductors

LED OSLON Square CSSRM2/CSSRM3
 FWHM / FWTM 15.0° / 29.0°
 Efficiency 95 %
 Peak intensity 10.4 cd/lm
 LEDs/each optic 1
 Light colour White
 Required components:

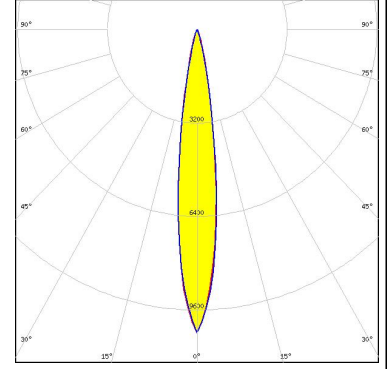

OSRAM Opto Semiconductors

LED SFH 4170S
 FWHM / FWTM 15.0° / 23.0°
 Efficiency 88 %
 LEDs/each optic 1
 Light colour IR
 Required components:

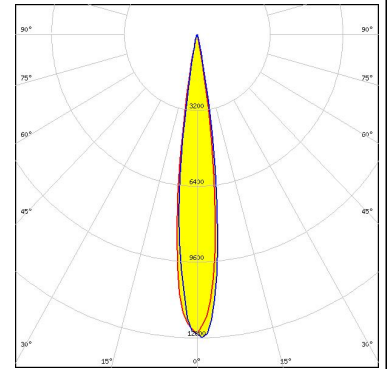

OSRAM Opto Semiconductors

LED SFH 4170S
 FWHM / FWTM 14.0° / 24.0°
 Efficiency 88 %
 LEDs/each optic 1
 Light colour IR
 Required components:

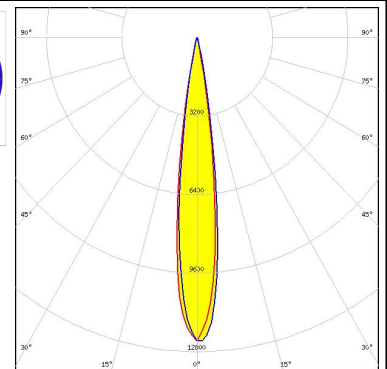
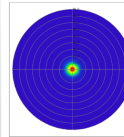
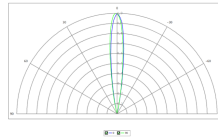

GENERAL INFORMATION:

NOTE: The typical beam angle will be changed by different color, chip size and chip position tolerance. The typical total beam angle is the full angle measured where the luminous intensity is half of the peak value.

MATERIALS:

As part of our continuous research and improvement processes, and to ensure the best possible quality and availability of our products, LEDiL reserves the right to change material grades without notice.

PRODUCT DATA USER AGREEMENT AND DISCLAIMER:

The measured data in the provided downloadable LEDiL Product Datasheets and Mechanical 2D-Drawings is rounded and provided as reference for planning. LEDiL Oy's optical specifications have been verified by conducting performance testing of the products in accordance with the company's quality system. The reported data are averaged results of multiple measurements with typical variation. LEDiL Oy reserves the right to without prior notification make changes and improvements to its products.

LEDiL Oy assumes neither warranty, nor guarantee nor any other liability of any kind for the contents and correctness of the provided data. The provided data has been generated with highest diligence but the provided data may in reality not represent the complete possible variation range of all intrinsic parameters. Therefore, in certain cases a deviation from the provided data could occur.

LEDiL Oy reserves the right to undertake technical changes of its products without further notification which could lead to changes in the provided data. LEDiL Oy assumes no liability of any kind for the possible deviation from any provided data or any other damage resulting from the usage of the provided data.

The user agrees to this disclaimer and user agreement with the download or usage of the provided files.

LEDiL Oy

Joensuunkatu 13
FI-24240 SALO
Finland

LEDiL Inc.

228 West Page Street
Suite D
Sycamore IL 60178
USA

Ledil Optics Technology (Shenzhen) Co., Ltd.

405 , Block B
Casic Motor Building
Shenzhen 518057
P.R.CHINA

Local sales and technical support

[www.ledil.com/
where_to_buy](http://www.ledil.com/where_to_buy)

Shipping locations

Salo, Finland
Hong Kong, China

Distribution Partners

[www.ledil.com/
where_to_buy](http://www.ledil.com/where_to_buy)