

DLC Display Co., Limited

德爾西顯示器有限公司



MODEL No: DLC0139BQOG

TEL: 86-755-86029824

FAX: 86-755-86029827

E-MAIL: sales@dlcdisplay.com

WEB: www.dlcdisplay.com



Record of Revision

Date	Revision No.	Summary
2018-04-28	1.0	Rev 1.0 was issued
2018-05-29	1.1	Add 8.4 Power IC Application Circuit 8.5 Display Initial Setting

1. Scope

This data sheet is to introduce the specification of DLC0139BQOG, AMOLED display module. It is composed of an AMOLED panel, driver IC and FPC. The 1.39" display area contains 400 (RGB) x 400 pixels.

2. Application

Digital equipments which need display, instrumentation, remote control, electronic product.

3. General Information

Item	Contents	Unit
Size	1.39	inch
Display Technology	AMOLED	/
Resolution	400(RGB)x400	/
Display Color	16.7M	/
Interface	MIPI	/
Outline Dimension	38.6 x 40.5 x 0.7	mm
Active Area	Φ35.4	mm
Driver IC	RAYDIUM RM67160	/
Operating Temperature	-20℃ ~ +60℃	/
Storage Temperature	-30℃ ~ +70℃	/

4. Outline Drawing

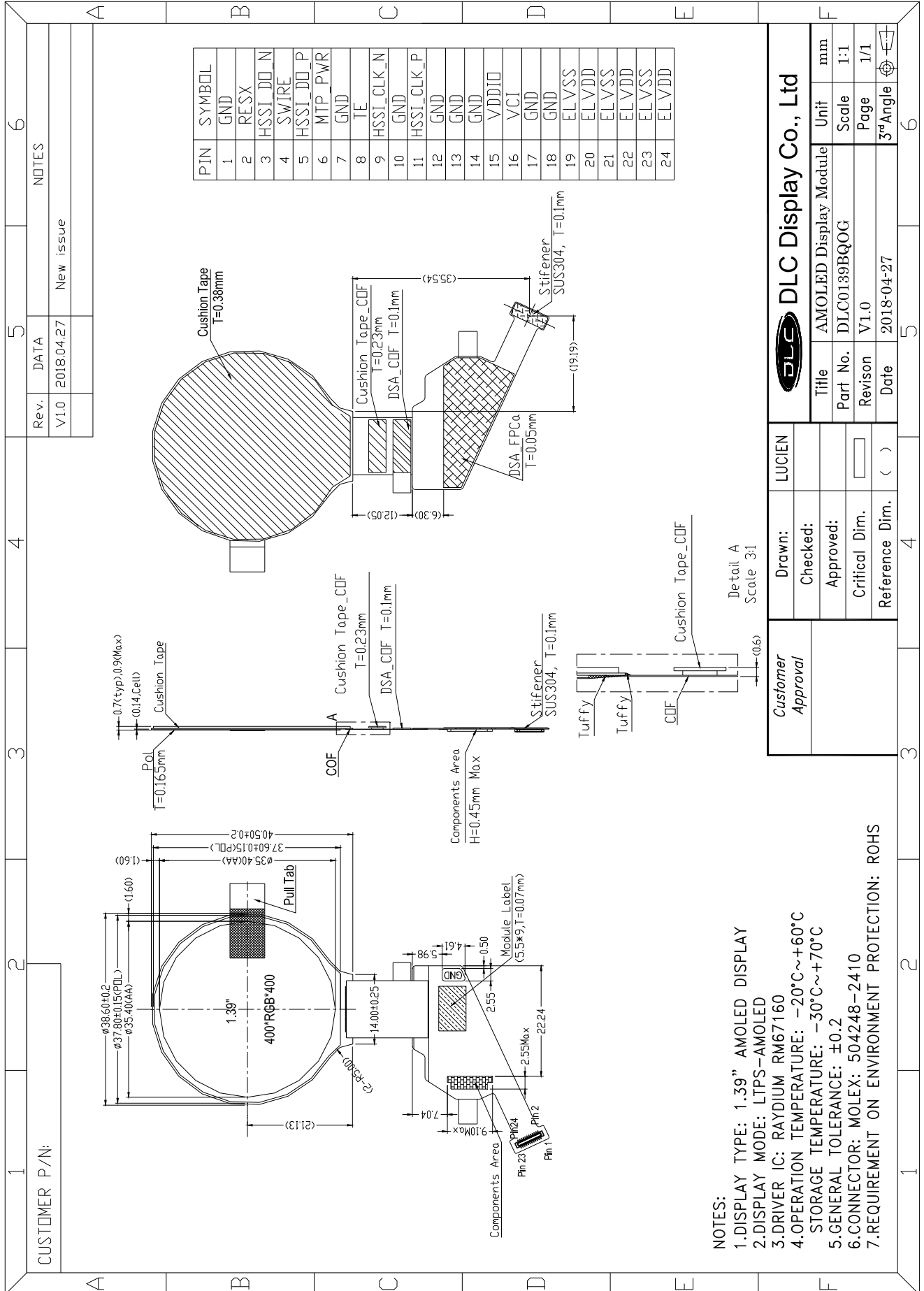

5. Interface signals

PIN NO.	PIN NAME	DESCRIPTION
1	GND	Power ground
2	RESX	Device reset signal (0: Enable; 1: Disable)
3	HSSI_D0_N	MIPI data negative signal
4	SWIRE	SWIRE signal for PWR IC control
5	HSSI_D0_P	MIPI data positive signal
6	MTP_PWR	MTP (need to indicate to connect GND or NC)
7	GND	Power ground
8	TE	Vsync(vertical sync) signal output from panel to avoid tearing effect
9	HSSI_CLK_N	MIPI negative clock signal
10	GND	Power ground
11	HSSI_CLK_P	MIPI positive clock signal
12	GND	Power ground
13	GND	Power ground
14	GND	Power ground
15	VDDIO	Power supply for interface system
16	VCI	Power supply for analog
17	GND	Power ground
18	GND	Power ground
19	ELVSS	AMOLED power negative
20	ELVDD	AMOLED power positive
21	ELVSS	AMOLED power negative
22	ELVDD	AMOLED power positive
23	ELVSS	AMOLED power negative
24	ELVDD	AMOLED power positive

FPCA recommended connector: 504248-2410 (Molex)

Main board recommended connector: 504208-2410 (Molex)

6. Environment Conditions

6.1 Electrical Absolute max. ratings

Parameter	Symbol	MIN	MAX	Unit	Remark
Supply voltage	VCI	-0.3	5.5	V	Power for digital circuit
	VDDIO	-0.3	5.5	V	Power for interface circuit
	ELVDD	-	5.0	V	Power for OLED
	ELVSS	-5.0	-	V	Power for OLED

Note1: All of the voltages listed above are with respective to GND= 0V.

Note2: Device is subject to be damaged permanently if stresses beyond those absolute maximum ratings listed above.

6.2 Environment Conditions

Item	Symbol	MIN	MAX	Unit	Remark
Operating Temperature	TOPR	-20	60	°C	
Storage Temperature	TSTG	-30	70	°C	

7. Electrical Specifications

7.1 Electrical characteristics

Item	Symbol	MIN	TYP	MAX	Unit	Remark
Supply voltage	VCI	2.7	2.8	3.6	V	
	VDDIO	1.65	1.8	3.3	V	
	ELVDD	4.55	4.60	4.65	V	
	ELVSS	-2.35	-2.4	-2.45	V	
Input voltage	"H" level	VIH	0.8*VDDIO	-	VDDIO	VDDIO= 1.65V~3.3V
	"L" level	VIL	0	-	0.2*VDDIO	
Output voltage	"H" level	VOH	0.8*VDDIO	-	VDDIO	
	"L" level	VOL	0	-	0.2*VDDIO	

Note: The operation is guaranteed under the recommended operating conditions only. The operation is not guaranteed if a quick voltage change occurs during the operation. To prevent the noise, a bypass capacitor must be inserted into the line closed to the power pin.

7.2 Power Consumption

Display Mode	Item	Symbol	Typ	Max
			Current(mA)	Current(mA)
100% Pixel On (Normal mode)	Current of VDDIO	IVDDIO	3.0	-
	Current of VCI	IVCI	6.1	-
	Current of ELVSS	IELVSS	20.5	-
50% Pixel On (Normal mode)	Current of VDDIO	IVDDIO	3.0	-
	Current of VCI	IVCI	6.1	-
	Current of ELVSS	IELVSS	10.3	-
ALL Pixel Off (Normal mode)	Current of VDDIO	IVDDIO	3.0	-
	Current of VCI	IVCI	6.0	-
	Current of ELVSS	IELVSS	0.0	-
ALL Pixel Off (Standby mode)	Current of VDDIO	IVDDIO	-	0.0
	Current of VCI	IVCI	-	<2uA
	Current of ELVSS	IELVSS	-	0

Note1: Power supply: VDDIO=1.8V , VCI=2.8V.

Note2: Frame frequency: Frame=60Hz@25degC, Brightness 300nits MIPI CMD mode.

Display Mode	Item	Symbol	Typ	Max
			Current(mA)	Current(mA)
10% Pixel On (Idle mode)	Current of VDDIO	IVDDIO	0.6	-
	Current of VCI	IVCI	2.6	-
	Current of ELVSS	IELVSS	0.2	-

Note1: Power supply: VDDIO=1.8V , VCI=2.8V.

Note2: Frame frequency: Frame=15Hz@25degC, Brightness 30nits MIPI CMD mode.

8. Command/AC Timing

8.1.MIPI Interface Characteristics

HS Data Transmission Burst

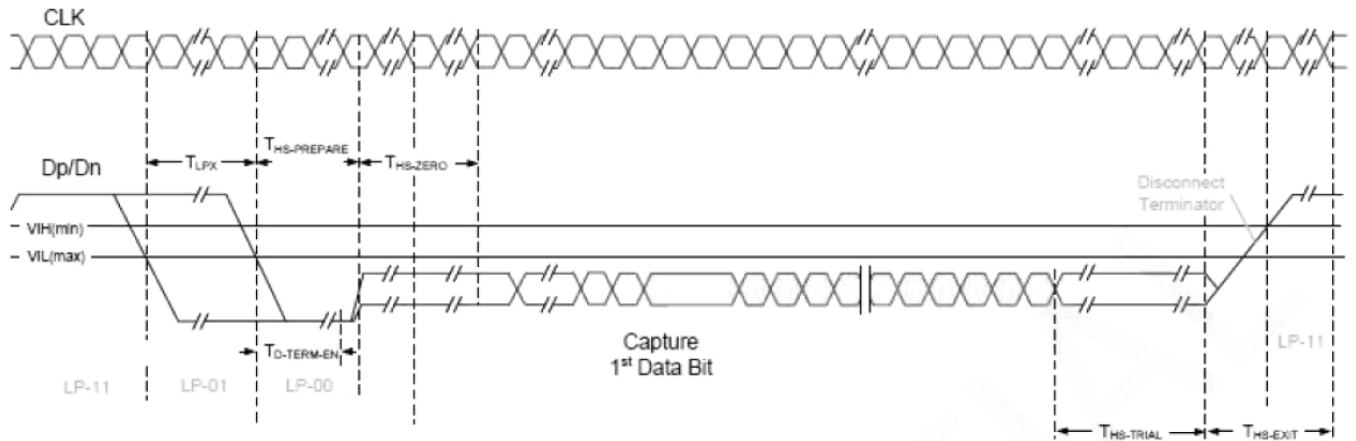

➤ HS clock transmission

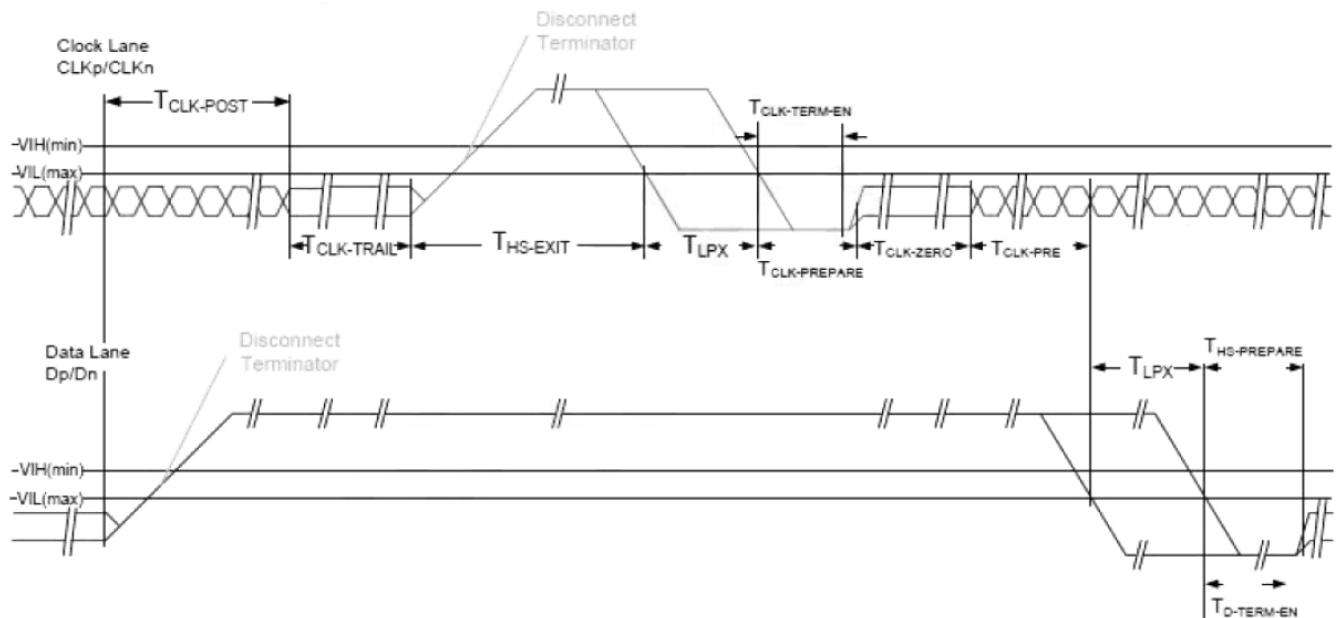

Turnaround Procedure

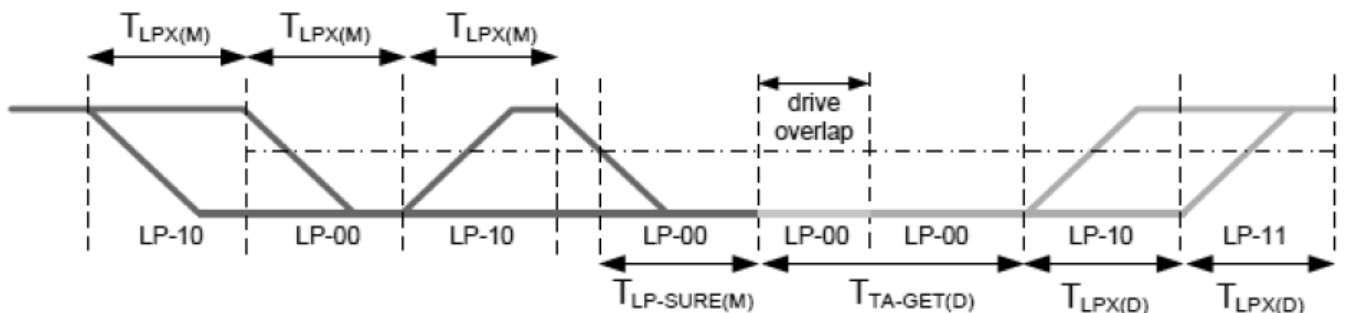



Timing Parameters: Parameter	Description	Min	Typ	Max	Unit
TCLK-POST	Time that the transmitter continues to send HS clock after the last associated Data Lane has transitioned to LP Mode. Interval is defined as the period from the end of THS-TRAIL to the beginning of TCLK-TRAIL .	60ns + 52*UI	-	-	ns
TCLK-TRAIL	Time that the transmitter drives the HS-0 state after the last payload clock bit of a HS transmission burst.	60	-	-	ns
THS-EXIT	Time that the transmitter drives LP-11 following a HS burst.	300	-	-	ns
TCLK-TERM-EN	Time for the Clock Lane receiver to enable the HS line termination, starting from the time point when Dn crosses VIL,MAX .	Time for Dn to reach VTERM-EN	-	38	ns
TCLK-PREPARE	Time that the transmitter drives the Clock Lane LP-00 Line state immediately before the HS-0 Line state starting the HS transmission.	38	-	95	ns
TCLK-PRE	Time that the HS clock shall be driven by the transmitter prior to any associated Data Lane beginning the transition from LP to HS mode.	8	-	-	UI
TCLK-PREPARE + TCLK-ZERO	TCLK-PREPARE + time that the transmitter drives the HS-0 state prior to starting the Clock.	300	-	-	ns
TD-TERM-EN	Time for the Data Lane receiver to enable the HS line termination, starting from the time point when Dn crosses VIL,MAX .	Time for Dn to reach VTERM-EN	-	35 ns +4*UI	ns
THS-PREPARE	Time that the transmitter drives the Data Lane LP-00 Line state immediately before the HS-0 Line state starting the HS transmission	40ns + 4*UI	-	60 ns + 6*UI	ns
THS-PREPARE + THS-ZERO	THS-PREPARE + time that the transmitter drives the HS-0 state prior to transmitting the Sync sequence.	145ns + 10*UI	-	-	ns
THS-TRAIL	Time that the transmitter drives the flipped differential state after last payload data bit of a HS transmission burst	60ns+4*UI	-	-	ns
TLPX(M)	Transmitted length of any Low-Power state period of MCU to display module	50	-	150	ns
TTA-SURE(M)	Time that the display module waits after the LP-10 state before transmitting the Bridge state (LP-00) during a Link Turnaround.	TLPX(M)	-	2*TLPX(M)	ns
TLPX(D)	Transmitted length of any Low-Power state period of display module to MCU	50	-	150	ns
TTA-GET(D)	Time that the display module drives the Bridge state (LP-00) after accepting control during a Link Turnaround.	5*TLPX(D)	-	-	ns
TTA-GO(D)	Time that the display module drives the Bridge state (LP-00) before releasing control during a Link Turnaround.	4*TLPX(D)	-	-	ns
TTA-SURE(D)	Time that the MPU waits after the LP- 10 state before transmitting the Bridge state (LP-00) during a Link Turnaround.	TLPX(D)	-	2*TLPX(D)	ns

8.2 Reset Timing

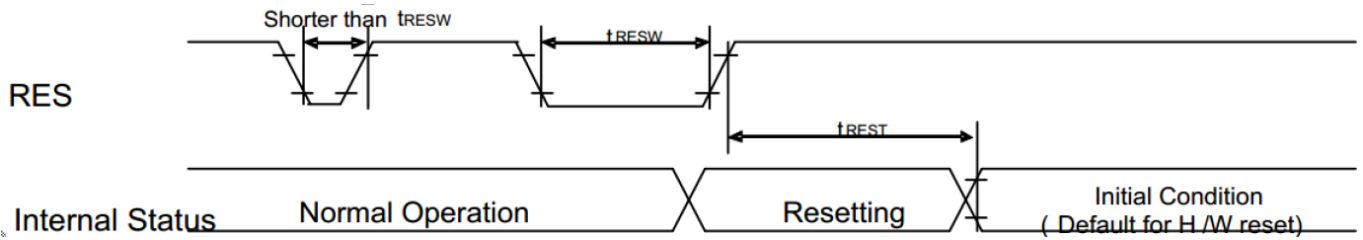

IOVDD=1.65 to 1.95V, VDD=2.8 to 3.1V, AGND=DGND=0V, Ta=-40 to 85°C

Item	Symbol	Related Pins	MIN	TYP	MAX	Unit	Remark
Reset low pulse width	tRESW	RESX	10	-	-	us	
Reset complete time	tREST		-	-	5	ms	When reset applied during Sleep in mod
					120	ms	When reset applied during Sleep out mode

Note 1: Spike due to an electrostatic discharge on RESX line does not cause irregular system reset according to the table below.

RESX Pulse	Action
Shorter than 5s	Reset Rejected
Longer than 10s	Reset
Between 5s and 15s	Reset starts (It depends on voltage and temperature condition)

Note 2: During the resetting period, the display will be blanked (The display is entering blanking sequence, which maximum time is 120 ms, when Reset Starts in Sleep Out –mode. The display remains the blank state in Sleep In –mode) and then return to Default condition for H/W reset.

Note 3: During Reset Complete Time, data in OTP will be latched to internal register during this period. This loading is done every time when there is H/W reset complete time (tREST) within 5ms after a rising edge of RESX.

Note 4: Spike Rejection also applies during a valid reset pulse as shown below:

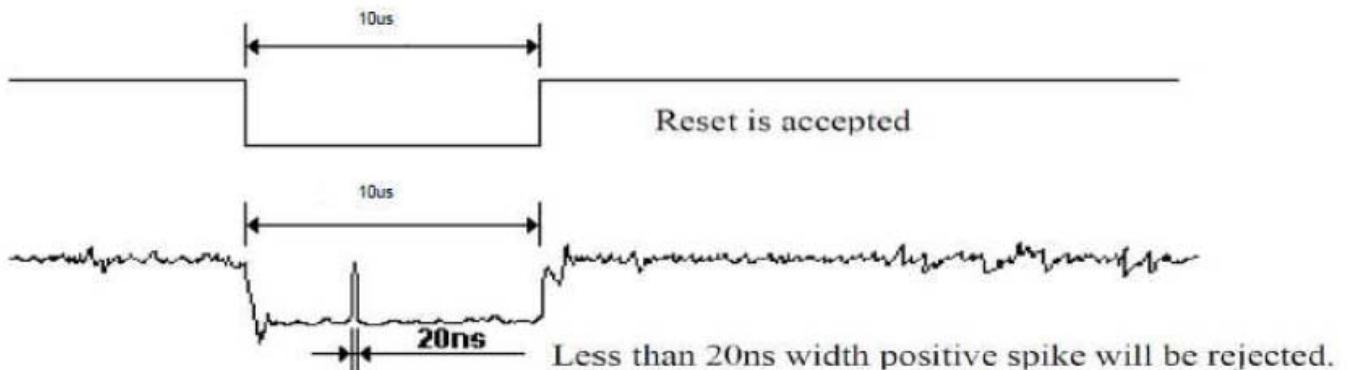

Note 5: It is necessary to wait 5msec after releasing RESX before sending commands. Also Sleep Out command cannot be sent for 120msec.

8.3 Operating Power Sequence

Power on sequence

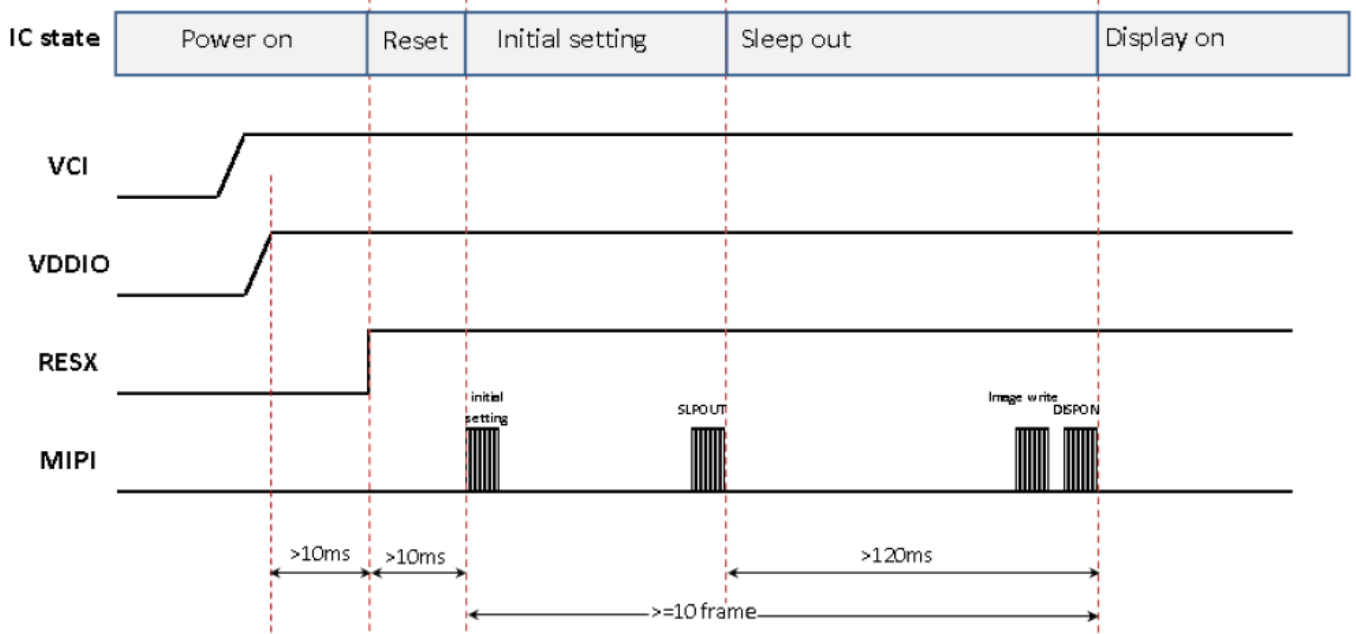

Power off sequence

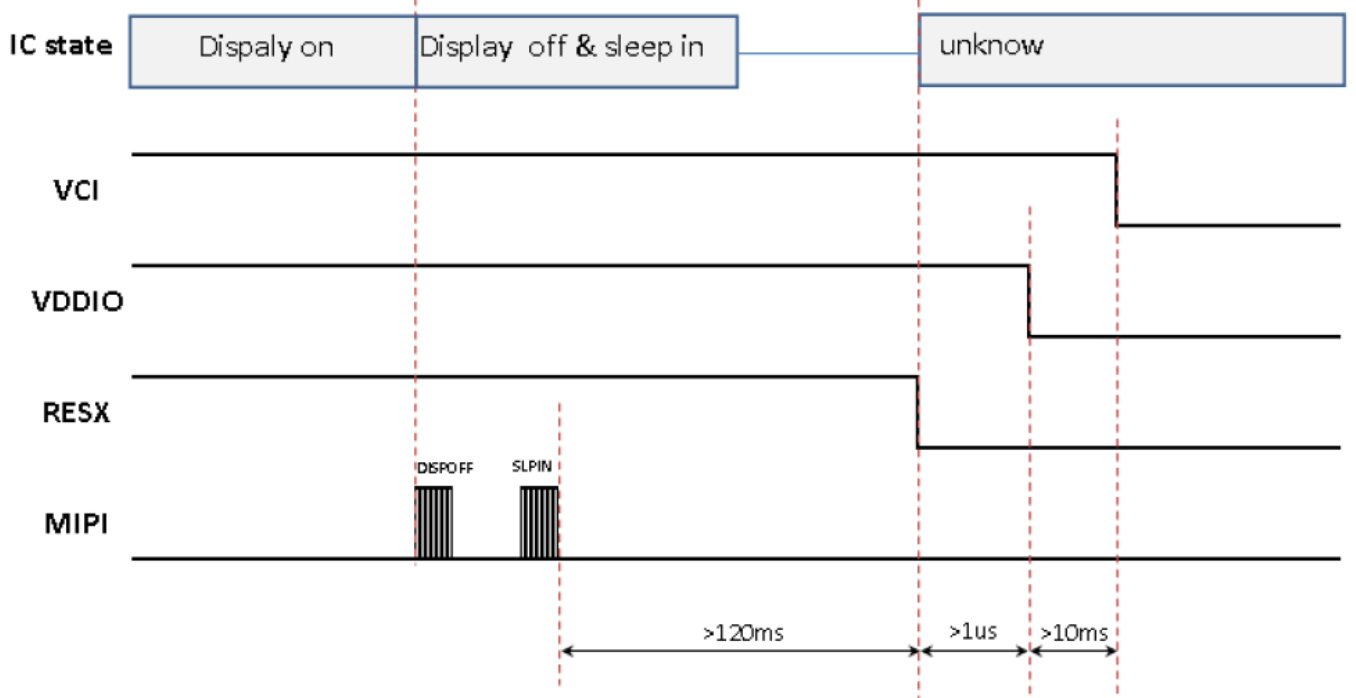

8.4 Power IC Application Circuit

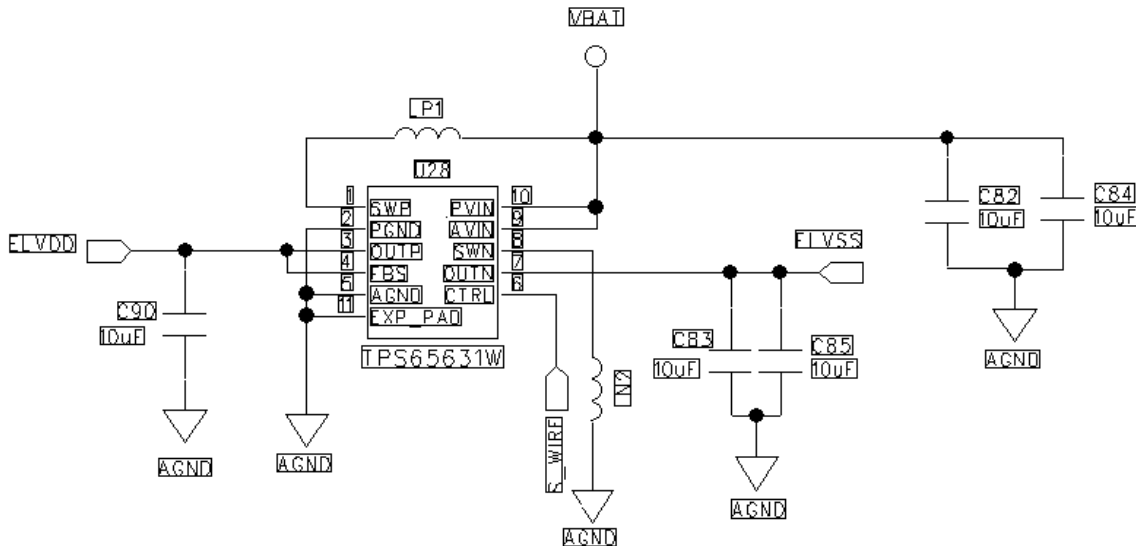

Note: OLED Power IC: TPS65631W
 Input: VBAT (2.9v ~ 4.4v)
 Output: ELVDD, ELVSS

8.5 Display Initial Setting

Recommended power on initial sequence								
Step	Instruction	Delay time	R/W	MIPI Data Type	Address		Data hex.	Description
					MIPI	Others		
1	Turn on VCI							VCI=2.8v
2	Turn on VDDIO							VDDIO=1.8v
3	Delay	No limit						
4	REST pin low	20us						
5	REST pin high							
6	Delay	5ms						
7			W	0x15	FE	FE00	00	
8			W	0x15	35	3500	01	
9	Sleep out		W	0x05	11	1100	00	
10	Delay	300ms						
11	Display on		W	0x05	29	2900	00	

9. Optical Specification

Item	Symbol	Condition	Min	Typ.	Max.	Unit	Remark
Contrast Ratio	CR	$\theta=0^\circ$	-	10,000	-		Note1 Note2
View Angles	θT	Cr \geq 10	80	-	-	Degree	Note 4
	θB		80	-	-		
	θL		80	-	-		
	θR		80	-	-		
Optical Switching Time	(Tr+Tf)/2	25°C	-	<4	-	ms	Note1 Note3
Chromaticity	White	x	Brightness is on	0.27	0.30	0.33	Note5, Note1
		y		0.28	0.31	0.34	
	Red	x		0.64	0.67	0.70	
		y		0.30	0.33	0.36	
	Green	x		0.19	0.24	0.29	
		y		0.65	0.70	0.75	
	Blue	x		0.09	0.13	0.17	
		y		0.025	0.065	0.105	
Luminance	L		250	300	-	cd/m2	Note1 Note6
Luminance Uniformity	-	-	80	-	-	%	Note7
NTSC	-	-	85	100	-	%	
Gamma	-	-	1.9	2.2	2.5		

Note 1: Definition of optical measurement system.

Temperature = 25°C(±3°C)

LED back-light: ON, Environment brightness < 150 lx

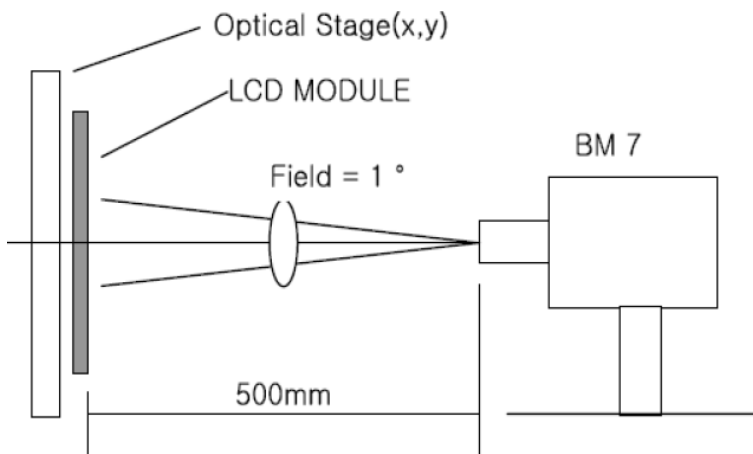

Note 2: Contrast ratio is defined as follow:

$$\text{Contrast Ratio} = \frac{\text{Surface Luminance with all white pixels}}{\text{Surface Luminance with all black pixels}}$$

Note 3: Response time is defined as follow:

Response time is the time required for the display to transition from black to white (Rise Time, T_r) and from white to black(Decay Time, T_f).

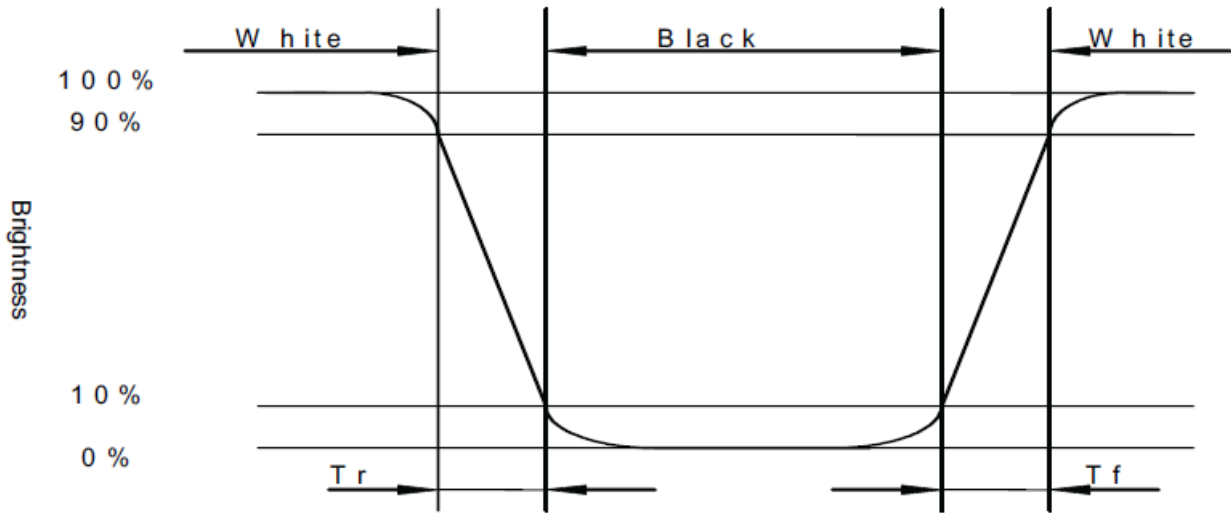

Note 4: Viewing angle range is defined as follow:

Viewing angle is measured at the center point of the LCD.

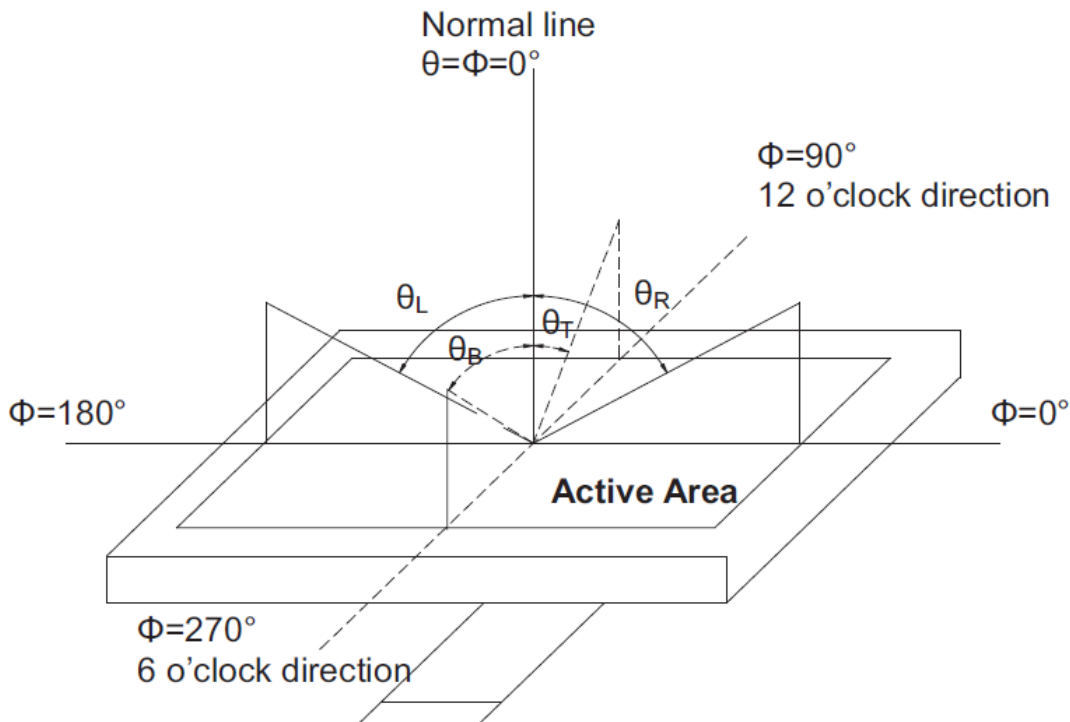

Note 5: Color chromaticity is defined as follow: (CIE1931)

Color coordinates measured at center point of LCD.

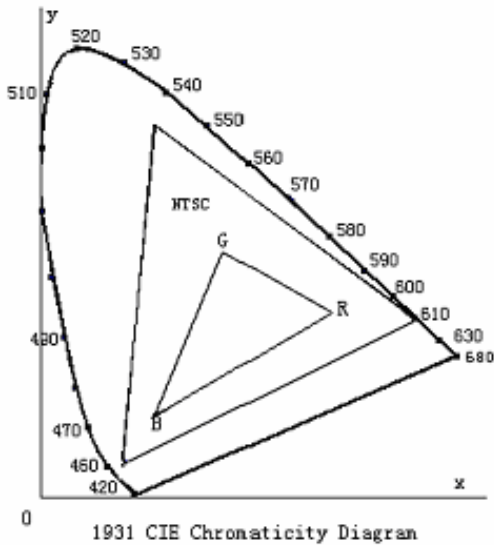

$$S = \frac{\text{area of RGB triangle}}{\text{area of NTSC triangle}} \times 100\%$$

Note 6: Luminance is defined as follow:

Luminance is defined as the brightness of all pixels “White” at the center of display area on optimum contrast.

Note 7: Luminance Uniformity

- Measurement equipment: CS2000 or similar equipment.
- Measuring surroundings: Dark room.
- Measuring temperature: Ta=25°C.
- The data are measured after OLEDs are lighted on for more than 5 minutes and all pixels are fully white.
- The Luminance Uniformity is calculated by using following formula:

$$\text{WHITE} = L_p (\text{Min.}) / L_p (\text{Max.}) \times 100 (\%)$$

Lp (Min.) = Minimum Luminance with all white pixels (P1, P2, P3, P4, P5)

Lp (Max.) = Maximum Luminance with all white pixels (P1, P2, P3, P4, P5)

10. Environmental / Reliability Tests

No	Test Item	Condition	Judgment criteria
1	High Temp Operation	Ts=+60°C, 120hrs	Per table in below
2	Low Temp Operation	Ta=-20°C, 120hrs	Per table in below
3	High Temp Storage	Ta=+70°C, 120hrs	Per table in below
4	Low Temp Storage	Ta=-30°C, 120hrs	Per table in below
5	High Temp & High Humidity Storage	Ta=+60°C, 90% RH 120 hours	Per table in below (polarizer discoloration is excluded)
6	Thermal Shock (Non-operation)	-30°C ~70°C, Dwell for 30 min. 100 cycles	Per table in below
7	ESD (Operation)	Voltage:±8KV, R: 330Ω, C: 150pF Air discharge, 10time	Per table in below
8	Vibration	Frequency : 10Hz~55Hz~10Hz Amplitude: 1.5mm, X, Y, Z direction for total 3hours (Packing condition)	Per table in below
9	Package Drop Test	Drop to the ground from 75cm height, one time, every side of carton. (Packing condition)	Per table in below

INSPECTION	CRITERION(after test)
Appearance	No Crack on the FPC, on the OLED Panel
Alignment of OLED Panel	No Bubbles in the OLED Panel No other Defects of Alignment in Active area
Electrical current	Within device specifications Current consumption: within · 50% of initial value.
Function / Display	No Broken Circuit, No Short Circuit or No Black line No Other Defects of Display

11. Precautions for Use of OLED Modules

11.1 Safety

The liquid crystal in the OLED is poisonous. Do not put it in your mouth. If the liquid crystal touches your skin or clothes, wash it off immediately using soap and water.

11.2 Handling

- A. The OLED and touch panel is made of plate glass. Do not subject the panel to mechanical shock or to excessive force on its surface.
- B. Do not handle the product by holding the flexible pattern portion in order to assure the reliability
- C. Transparency is an important factor for the touch panel. Please wear clear finger sacks, gloves and mask to protect the touch panel from finger print or stain and also hold the portion outside the view area when handling the touch panel.
- D. Provide a space so that the panel does not come into contact with other components.
- E. To protect the product from external force, put a covering lens (acrylic board or similar board) and keep an appropriate gap between them.
- F. Transparent electrodes may be disconnected if the panel is used under environmental conditions where dew condensation occurs.
- G. Property of semiconductor devices may be affected when they are exposed to light, possibly resulting in IC malfunctions.
- H. To prevent such IC malfunctions, your design and mounting layout shall be done in the way that the IC is not exposed to light in actual use.

11.3 Static Electricity

- A. Ground soldering iron tips, tools and testers when they are in operation.
- B. Ground your body when handling the products.
- C. Power on the OLED module before applying the voltage to the input terminals.
- D. Do not apply voltage which exceeds the absolute maximum rating.
- E. Store the products in an anti-electrostatic bag or container.

11.4 Storage

- A. Store the products in a dark place at $+25^{\circ}\text{C}\pm 10^{\circ}\text{C}$ with low humidity (40% RH to 60% RH). Don't expose to sunlight or fluorescent light.
- B. Storage in a clean environment, free from dust, active gas, and solvent.

11.5 Cleaning

- A. Do not wipe the touch panel with dry cloth, as it may cause scratch.
- B. Wipe off the stain on the product by using soft cloth moistened with ethanol. Do not allow ethanol to get in between the upper film and the bottom glass. It may cause peeling issue or defective operation. Do not use any organic solvent or detergent other than ethanol.

11.6 Cautions for installing and assembling

- A. Bezel edge must be positioned in the area between the Active area and View area. The bezel may press the touch screen and cause activation if the edge touches the active area. A gap of approximately 0.5mm is needed between the bezel and the top electrode. It may cause unexpected activation if the gap is too narrow. There is a tolerance of 0.2 to 0.3mm for the outside dimensions of the touch panel and tail. A gap must be made to absorb the tolerance in the case and connector.
- B. In order to make the display assembly stable and firm, DLC recommends to design some supporting at the display backside, especially for the display with tape-attached touch panel, such supporting is important and essential, or else, the display may drop-off from front after some period of time.
- C. Do not display the fixed pattern for a long time because it may develop image sticking due to the LCD structure. If the screen is displayed with fixed pattern, use a screen saver.

