

AHT20 Product manuals

Temperature and Humidity sensor

- Full calibration
- Digital output, I²C interface
- Excellent long-term stability
- SMD package suitable for reflow soldering
- Quick response and strong anti-jamming capability



Product Overview

AHT20, as a new generation of temperature and humidity sensors, has established a new standard in size and intelligence. It is embedded in a double row flat no-lead package suitable for reflow soldering, with a bottom of 3 x 3 mm and a height of 1.0 mm. The sensor outputs calibrated digital signals in standard I²C format. AHT20 is equipped with a newly designed ASIC chip, an improved MEMS semiconductor capacitive humidity sensing element and a standard on-chip temperature sensing element.

As a result, the performance of the new generation of temperature and humidity sensors has greatly improved or even exceeded that of the previous ones with more stability in harsh environments. Each sensor is calibrated and tested, with product batch number printed on the surface of the product. Due to the improvement and miniaturization of the sensor, its cost-effective ratio is higher, and finally all equipment will benefit from the cutting-edge energy-saving operation mode.

Application Scope

HVAC system, dehumidifier, test and inspection equipment, consumer goods, automobiles, automatic control, data recorder, weather station, household appliances, humidity regulation, medical and other related temperature and humidity detection and control.

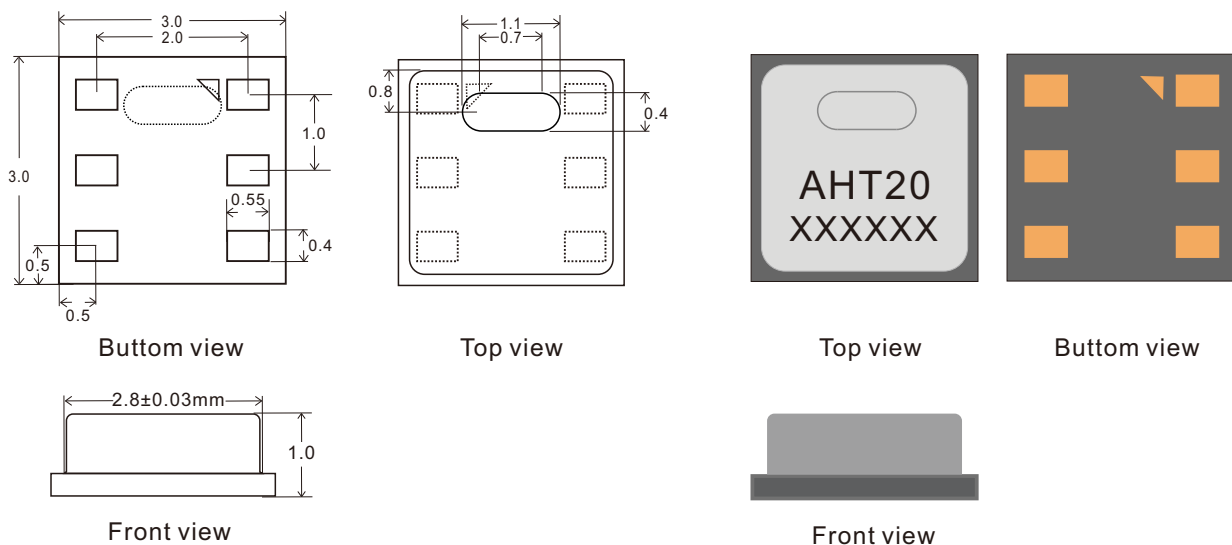

Figure 1: AHT20 Sensor Package Diagram (Unit: mm Tolerance: ±0.1 mm)

Sensor Performance

Relative Humidity

Parameter	Condition	Min	Typical	Max	Unit
resolution ratio	Typical		0.024		%RH
accuracy error ¹	Typical		±2		%RH
	Max	Figure 2			%RH
Repeatability			±0.1		%RH
Hysteresis			±1		%RH
Nonlinear			<0.1		%RH
Response time ²	t 63%		8		S
Scope of work	extended ³	0		100	%RH
Long time drift ⁴	Normal		<1		%RH/yr

Table 1 Humidity Characteristic

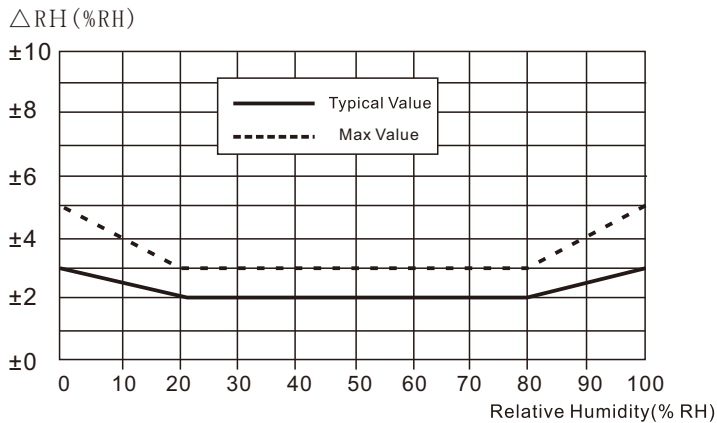

Figure 2 The maximum error of relative humidity at 25°C

Temperature

Parameter	Condition	Min	Typical	Max	Unit
resolution ratio	Typical		0.01		°C
accuracy error ¹	Typical		±0.3		°C
	Max	Figure 3			°C
Repeatability			±0.1		°C
Hysteresis			±0.1		°C
Response time ⁶	t 63%	5		30	S
Scope of work	extended ³	-40		85	°C
Long time drift			<0.1		°C/yr

Table 3 Temperature Characteristic

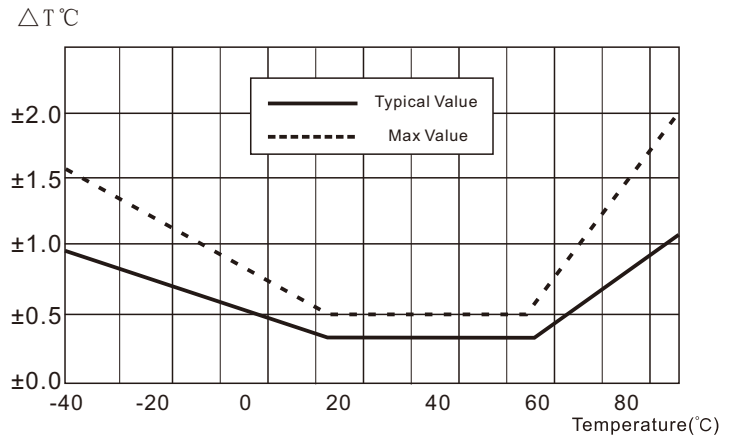

Figure 3 Typical error and maximum error of temperature

Electric Specification

Parameter	Condition	Min	Typical	Max	Unit
Voltage	Typical	2.0	3.3	5.5	V
Current, IDD ⁵	Dormant	-		250	μA
	Measure		320		μA
Power consumption ⁵	Dormant	-		0.9	μW
	Measure		0.07		mW
	Average	-	3.3	-	μW
Communication	Two-line digital interface, standard I ² C protocol				

Table 2 Electric Specification

Package Information

Sensor Model	Package	Quantity
AHT20	Tape package	5000PCS/Roll(MAX)

Table 4 Package

¹This precision is the test precision of the sensor with 3.3V voltage at 25°C excluding hysteresis and nonlinearity, and only suitable for non-condensation conditions.

²The time required to reach 63% of the first-order response under the conditions of 25°C and 1 m/s air flow.

³Normal working scope: 0 - 80% RH. Sensor reading will be deviated if beyond this range, (drift < 3% RH after 200 hours at 90% RH humidity). The working scope is further limited to -40~80°C.

⁴If the sensor is surrounded by volatile solvents, irritating tapes, adhesives and packaging materials, the reading may be higher. For more information, please refer to the relevant documents.

⁵The minimum and maximum of supply current and power consumption are based on the conditions of VDD = 3.3 V and T < 60 °C. The average value is value measured every two seconds.

⁶The response time depends on the thermal conductivity of the sensor substrate.

AHT20 User Guide

1 Expansion of performance

1.1 Working Conditions

The sensor performance is stable in the suggested working scope, as shown in Figure 4. Long-term exposure to abnormal scope, especially when humidity > 80%, may lead to temporary signal drift (drift + 3% RH after 60 hours). When the sensor is restored to normal working conditions, it will slowly restore itself to the correct state. Refer to Recovery Processing in Section 2.3 to speed up the recovery process. Long-term use under abnormal conditions will accelerate the aging of products.

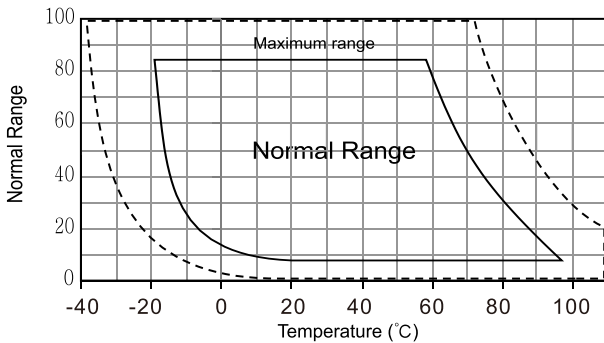

Figure 4 Working Conditions

1.2 RH Accuracy at Different Temperatures

The RH accuracy at 25°C is defined in Fig. 2, and the maximum humidity error at other temperatures is shown in Fig. 5.

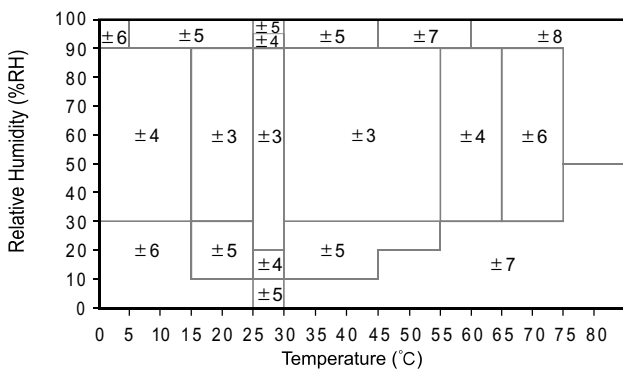

Figure 5 Maximum humidity error between 0~80 °C, unit: (% RH)

Note: Above errors are the tested maximum errors (excluding hysteresis) with the high precision dew-point instrument as reference in instrument. In the norm where the maximum error is ±3% RH, the typical error is ±2%RH; in other ranges, the typical value is 1/2 of the maximum error value.

1.3 Electric Specification

The power consumption given in Table 1 is related to temperature and supply voltage VDD. Estimated power consumption, see Figures 6 and 7. Note that the curves in Figures 6 and 7 are typical natural characteristics and may have deviations.

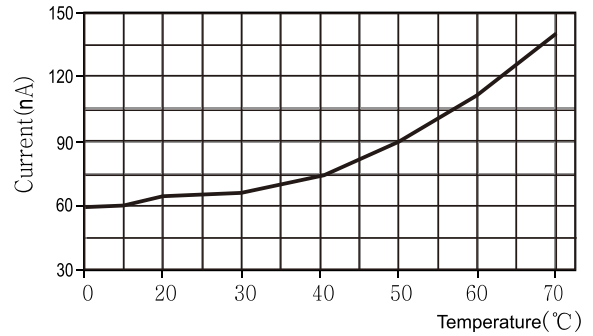

Figure 6 When VDD = 3.3V, the typical relationship between supply current and temperature (dormancy mode). Please note that there is a deviation of about ± 25% with the display value.

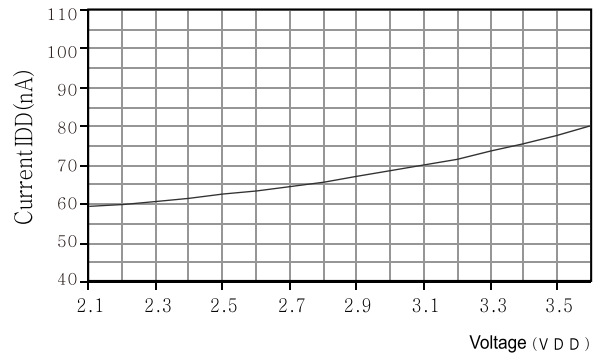

Figure 7 shows the typical relationship between supply current and voltage (dormancy mode) at 25 °C. Please be noted that the deviation between these data and the display value may reach ± 50 % of the display value. At 60 °C, the coefficient is about 15. (Compared with Table 2).

2 Application Information

2.1 Welding Specification

The I/O pads of SMD are made of copper pin frame planar substrates, which are exposed to the outside for mechanical and electrical connections. When used, I/O pads and bare pads need to be welded on PCB. In order to prevent oxidation and optimize welding, the welding joints at the bottom of the sensor are plated with Ni/Au.

On PCB, the length of I/O contact surface should be 0.2 mm longer than that of the I/O package pad of AHT20. The inner part should match the shape of the I/O package pad. The ratio of pin width to SMD package pad width is 1:1. See figure 8.

For screen and solder layer design⁷, it is suggested to use copper foil definition solder (SMD) with the solder layer opening larger than the metal solder plate.

For SMD pads, if the gap between the copper foil pad and the soldering layer is 60m-75m, the opening size of the soldering layer shall be greater than the size of the soldering plate (120 m-150 m).

The circular part of the sealing pad shall match the corresponding circular solder layer opening to ensure that there is enough solder layer area (especially at the corner) to prevent solder from joining.

Each pad shall have its own soldering layer opening, forming a soldering layer network around the adjacent pads.

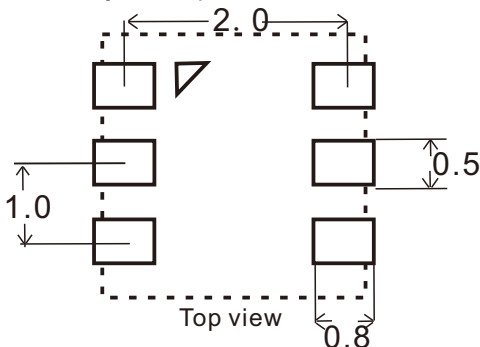

Figure 8 Recommended design size of AHT20 PCB (mm) and the outer part with dotted line is the outer dimension of SMD package.

For solder printing, laser cutting stainless steel mesh with electronic polishing trapezoidal wall is recommended, with recommended thickness of 0.125 mm. The steel mesh size of the pad should be 0.1 mm longer than PCB pad and placed 0.1 mm away from the packaging center. Steel mesh with bare pads must cover 70% - 90% of the pad area - that is, the central position of the heat dissipation area reaches 1.4 mm x 2.3 mm.

Due to the low SMD mounting, it is recommended to use no-cleaning type 3 solders⁸ tin and to purify it with nitrogen during reflux.

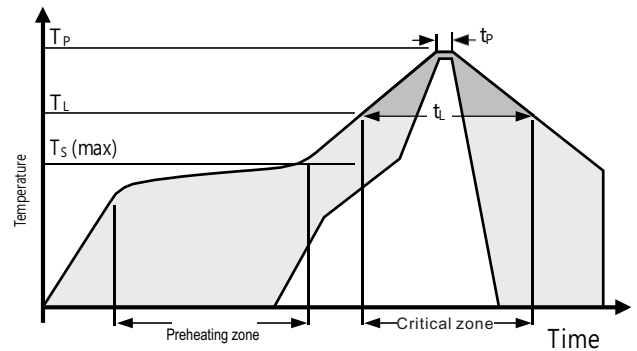

Figure 9 JEDEC Standard welding procedure diagram. $T_p \leq 260^\circ\text{C}$, $t_p < 30$ sec, lead-free welding. $T_L < 220^\circ\text{C}$, $t_i < 150$ sec, The rate of temperature rise and fall during welding shall be $< 5^\circ\text{C}/\text{sec}$.

AHT 20 can be welded through standard reflow furnace. The sensor fully meets the IPC/JEDEC J-STD-020D welding standard. The contact time should be less than 30 seconds at the highest 260°C (see Fig. 9) and the ultimate welding temperature that the sensor can withstand is 260°C , so it is recommended to use low temperature 180°C when reflow soldering.

Note: After reflow welding, the sensor should be stored in the environment of $> 75\%$ RH for at least 12 hours to ensure the re-hydration of the polymer. Otherwise, it will cause sensor reading drift. The sensor can also be placed in a natural environment ($> 40\%$ RH) for more than five days to re-hydrate. Hydration time can be reduced by using low temperature reflow welding (e.g. 180°C).

Don't wash the circuit boards is allowed after welding. Therefore, it is suggested that customers use "wash-free" solder paste. If the sensor is applied to corrosive gases, condensate water may be produced (e.g. in high humidity environment), both pin pads and PCB need to be sealed (e.g. using conformal coating) to avoid poor contact or short circuit.

2.2 Storage conditions and instructions

The humidity sensitivity level (MSL) is 1, according to IPC/JEDEC J-STD-020 standard. Therefore, it is recommended to use it within one year after delivery.

Humidity sensor is not an ordinary electronic component, and it needs careful protection, which users must pay attention to. Long-term exposure to high concentration of chemical vapor will cause the sensor reading to drift.

⁷Contact surface refers to the metal layer on PCB where SMD pads are welded.

⁸The solder mask layer refers to the insulating layer covering the connecting line at the top of the PCB.

⁹The type of solder is related to the size of particles in solder. Type 3 powder in size range of 25-45 μm .

Therefore, it is recommended that the sensor be stored in the original package including sealed ESD bag, and meet the following conditions: temperature range 10~50°C (0~85°C in a limited time), humidity 20~60% RH(no ESD packaged sensor). For sensors that they be stored in antistatic bags made of metal PET/AL/CPE.

During production and transportation, sensors should avoid exposure to high concentration of chemical solvents and prolonged exposure. Avoid exposure to volatile glue, adhesive tape, stickers or volatile packaging materials, such as foamed foil, foam material, etc. The production area should be well ventilated.

2.3 Recovery processing

As mentioned above, if the sensor is exposed to extreme working conditions or chemical vapor, the reading will drift. It can be restored to the calibration state by processing as follows. Drying: Keep for 10 hours at 80~85°C with the humidity of more than 75% RH.

Rehydration: Keep for 12 hours at 20~30°C with the humidity of more than 75% RH.¹⁰

2.4 Temperature influence

The relative humidity of gases depends largely on temperature. Therefore, when measuring humidity, all sensors measuring the same humidity should work at the same temperature as possible. When testing, it is necessary to ensure that the same temperature, and then compare the humidity readings.

If the sensor and the heating-prone electronic components are placed on the same printing circuit board, measures should be taken to minimize the effect of heat transfer as far as possible in the design of the circuit.

For example, to maintain good ventilation of the shell, the copper coating of AHT20 and other parts of the printed circuit board should be as smallest as possible, or leave a gap between them. (See Fig. 10)

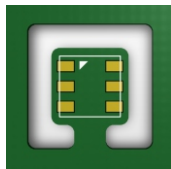

Figure 10 AHT20 top view of printing circuit board. The design of milling slit can minimize heat transfer.

Moreover, when the measurement frequency is too high, the temperature of the sensor itself will rise, which will affect the measurement accuracy. In order to make its temperature rise below 0.1 , the activation time of AHT20 should not exceed 10% of the measurement time - it is recommended to measure data every 1 first.

¹⁰75 % RHIt can be easily generated from saturated Na Cl.

2.5 Product application scenario design

In product design, the sensor has following characteristics:

1) Sensor is in full contact with the outside air

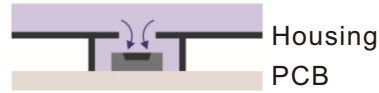

Figure 10: Suitable windows on the enclosure provide good access to environmental measurements and allow for greater air exchange.

2) The sensor is completely isolated from the air inside the housing



Figure 12: The sensor is isolated from the air inside the housing, which minimizes the impact of the air inside the housing on the sensor.

3) Small measurement dead zone around the sensor



Figure 13: Small measurement dead zone helps the sensor to quickly and comprehensively detect environmental changes.

4) The sensor is isolated from the heat

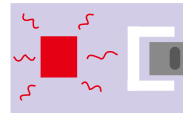

Figure 14: The sensor is isolated from the internal heat source to minimize the effect of internal heat on sensor.

5) The sensor power supply can be controlled

In order to improve the stability of the system, the following two solutions for controlling power supply are provided:

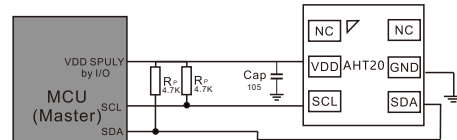

Figure 15-1 Typical application circuit ①, the pull-up voltage and VDD of SCL and SDA are powered by the MCU.

Note: 1. The host MCU supplies AHT20 with a voltage range of 2.0 ~ 5.5V.

2. When the AHT20 is just powered on, the MCU gives priority to the VDD power supply, which can be set after 5ms SCL and SDA are high.

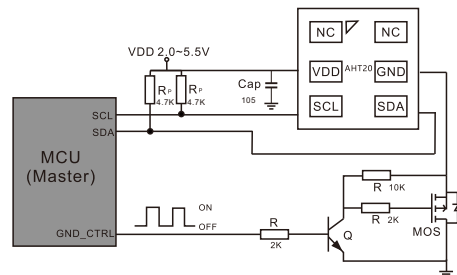

Figure 15-2 Typical application circuit ②, AHT20 operation is controlled by whether GND is grounded.

Note: The user can indirectly control the GND and ground by controlling the switch module composed of transistors, so that the AHT20 is powered off.

2.6 Material used for sealing and encapsulation

Many materials absorb moisture and act as buffer, which will increase response time and hysteresis. Therefore, the material around the sensor should be carefully selected. Recommended materials are: Metal materials, LCP, POM (Delrin), PTFE (Teflon), PE, PEEK, PP, PB, PPS, PSU, PVDF, and PVF. Material for sealing and bonding (conservative recommendation): It is recommended to use method of filling epoxy resin or silicone resin for packaging electronic components. Gases released from these materials may also contaminate AHT20 (see 2.2). Therefore, the sensor should be finally assembled and placed in a well-ventilated place, or dried for 24 hours in an environment of > 50°C, in order to release the contaminated gas before packaging.

2.7 Wiring rules and signal integrity

If the SCL and SDA signal lines are parallel and very close to each other, it may cause signal crosstalk and communication failure. The solution is to place VDD and / or GND between the two signal lines, separate the signal lines, and use shielded cables. In addition, reducing the SCL frequency may also improve the integrity of signal transmission. A 1uF decoupling capacitor must be added between the power supply pins (VDD, GND) for filtering. This capacitor should be as close as possible to the sensor. See the next chapter.

3.2 Serial clock SCL

SCL is used to synchronize the communication between microprocessor and AHT20. Because the interface contains complete static logic, there is no minimum SCL frequency.

3.3 Serial data SDA

SDA pins are used for data input and output of sensors. When sending commands to sensors, SDA is valid at the rising edge of serial clock (SCL), and SDA must remain stable when SCL is high level. After the descending edge of SCL, the SDA value can be changed. To ensure communication safety, the effective time of SDA should be extended to TSU and THO respectively before SCL rising edge and after SCL falling edge-refer to Fig 17. When the data is read from the sensor, SDA is valid (TV) after the SCL decreases and maintains the descent edge of the next SCL.

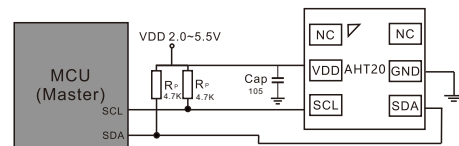

Figure 16 Typical application circuit

- Note: 1. The pull-up voltage of SCL and SDA must be powered by VDD, and the power supply voltage range is 2.0 ~ 5.5V;
- 2. Add 1uF decoupling capacitor between VDD and GND;

3 Interface Definition

Pin	Name	Definition
1	NC	Remain suspended
2	VDD	Power supply voltage
3	SCL	Serial clock
4	SDA	Serial data, bidirectional
5	GND	Power ground
6	NC	Remain suspended

Top view

Table 5 AHT20 Distribution of pins (Top View)

3.1 Power Pins (VDD,GND)

The power supply range of AHT20 is 2.0-5.5V, and the recommended voltage is 3.3V. A decoupling capacitor of 1uF must be added between VDD and GND to play a filtering role. VDD is powered on preferentially or synchronously than SDA and SCL to avoid the leakage current from the signal line (SCL / SDA) sinking in, causing the chip to be in a non-working state after power-on.

4 Electric Specification

4.1 Absolute Maximum Rating

The electric specifications of AHT20 are defined in Table 2. The absolute maximum ratings given in Table 6 are only stress ratings and to provide more information. Under such conditions, it is not advisable for the device to perform functional operation. Exposure to absolute maximum rating or a long time may affect the reliability of the sensor.

Parameters	Min	Max	Unit
VDD to GND	-0.3	5.5	V
Digital I/O pin (SDA, SCL) to GND	-0.3	VDD + 0.3	V
Input current for each pin	-10	10	mA

Table 6 Absolute maximum electric rating

ESD electrostatic discharge conforms to JEDEC JESD22-A114 standard (human body mode $\pm 4kV$) and JEDEC JESD22-A115 (machine mode $\pm 200V$) If the test condition exceeds the nominal limit, the sensor needs additional protection circuit.

4.2 Input/output characteristics

Electric specifications include power consumption, high and low voltage of input and output, voltage of power supply. In order to make the sensor communication smooth, it is important to ensure that the signal design is strictly limited to the range given in tables 7, 8 and 17.

Parameter	Condition	Min	Typic	Max	Unit
Output low voltage VOL	VDD = 3.3 V, -4 mA < IOL < 0mA	0	-	0.4	V
Output high voltage VOH		70% VDD	-	VDD	V
Output sink current IOL		-	-	-4	mA
Input low voltage VIL		0	-	30% VDD	V
Input high voltage VIH		70% VDD	-	VDD	V
Input current	VDD = 5.5 V, VIN = 0 V to 5.5 V	-	-	± 1	μA

Table 7 Direct current characteristics of DIO pads, if without special declaration, VDD = 2.0V to 5.5V, T = -40 °C to 85 °C.

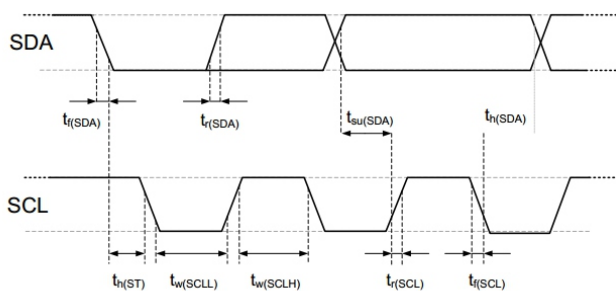

Figure 17 The sequence diagrams and abbreviations of digital input/output are explained in Table 8. Thicker SDA lines are controlled by sensors, and ordinary SDA lines are controlled by single chip computer. Please be noted that the effective read time of SDA is triggered by the drop edge of the previous conversion

Parameter	Mark	I ² C Typical Mode		I ² C High speed mode		Unit
		MIN	MAX	MIN	MAX	
I ² C clock frequency	fSCL	0	100	0	400	KHz
Initial signal time	tHDST A					μs
SCL Clock High Level Width	tHIGH	4.7		1.3		μs
SCL Clock Low Level Width	tLOW	4.0		0.6		μs
Data save time relative to SCL SDA edge	tHDDA T	0.09	3.45	0.02	0.9	μs
Data Setting Time Relative to SCL SDA Edge	tSUDA T	250		100		μs

Note: Both pins are measured from 0.2 VDD and 0.8 VDD.
 Note: The above I²C time serial is determined by the following internal delays:
 (1)The internal SDI input pins are delayed relative to SCK pins with a typical value of 100ns.
 (2)The internal SDI output pin is delayed relative to SCK falling edge with a typical value of 200 ns.

Table 8. I²C Sequence Characteristics of Digital Input/output in fast Mode. The specific meaning is shown in Figure 12. Unless otherwise indicated

5 Sensor Communication

AHT20 adopts standard I²C protocol to communicate. For information on the I²C protocol except the following chapters, please refer to the following website: www.aosong.com for sample reference.

5.1 Start Sensor

Step 1: Make the sensor power on with selected voltage of VDD power supply voltage (ranging from 2.0V to 5.5V). When the sensor is powered on, it takes 20 milliseconds at most (the SCL is high level) to enter idle state, that is, to be ready to receive commands sent by MCU.

5.2 Timing sequence of start/stop

Each transport sequence starts with the Start state and ends with the Stop state, as shown in Figures 18 and 19.

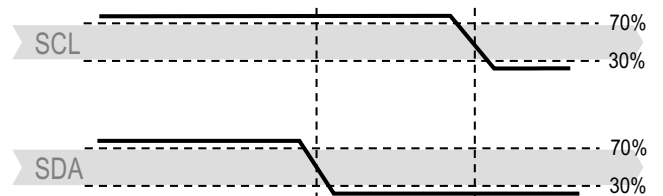

Figure 18 Start Transmit State (S) - When SCL is at high level, SDA is converted from high level to low level. The start state is a special bus state controlled by the main engine, indicating the start of slave machine transit (after Start, BUS is generally considered to be in a busy state).

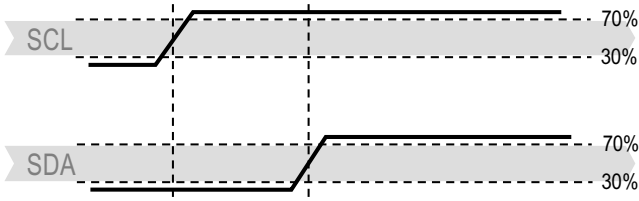
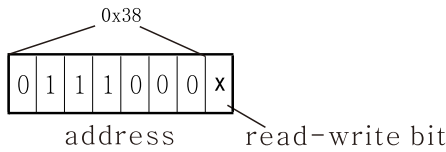

Figure 19 Stop Transmit State (P) - When the SCL is at high level, the SDA line is converted from low level to high level. Stop state is a special bus state controlled by the main engine, indicating the end of slave machine transmit (after Stop, BUS is generally considered to be in idle state).

5.3 Send Command

After the transmission is initiated, the first byte of the subsequent I2C transmission includes the 7-bit I2C device address 0x38 and a SDA direction bit x (read R: '1', write W: '0'). After the falling edge of the 8th SCL clock, the SDA pin (ACK) is pulled low to indicate that the sensor data reception is normal. After issuing the initialization command 0xBE and the measurement command 0xAC, the MCU must wait until the measurement is completed. The basic commands are summarized in Table 9. Table 10 shows the status bits returned from the slave.



Command	Definition	Code
Initialization	Keep main engine	1011'1110(0xBE)
Trigger Measurement	Keep main engine	1010'1100(0xAC)
Soft reset		1011'1010(0xBA)

Table 9 Basic Commands

Bit	Definition	Description
Bit[7]	(Busy indication)	1 -- Busy in measurement 0 -- Free in dormant state
Bit [6:5]	Remained	Remained
Bit [4]	Remained	Remained
Bit [3]	CAL Enable	1--calibrated 0--uncalibrated
Bit [2:0]	Remained	Remained

Table 10 State bit description.

5.4 Sensor reading process

1. Wait 40ms after power-on. Before reading the temperature and humidity values, first check whether the calibration enable bit Bit [3] of the status word is 1 (you can get a byte of status word by sending 0x71). If not 1, need to send 0xbe command (for initialization), this command parameter has two bytes, the first byte is 0x08, the second byte is 0x00, and then wait for 10ms.
2. Send the 0xAC command directly (trigger measurement). The parameter of this command has two bytes, the first byte is 0x33 and the second byte is 0x00.
3. Wait for 80ms to wait for the measurement to be completed. If the read status word Bit [7] is 0, it indicates that the measurement is completed, and then six bytes can be read in a row; otherwise, continue to wait.
4. After receiving six bytes, the next byte is the CRC check data, the user can read it as needed, if the receiving end needs CRC check, then send it after receiving the sixth byte ACK response, otherwise NACK is sent out, CRC initial value is 0xFF, CRC8 check polynomial is:

$$CRC[7:0]=1+x^4+ x^5+ x^8$$

5. Calculate the temperature and humidity values.

Note: The calibration status check in the first step only needs to be checked at power-on. No operation is required during the normal acquisition process.

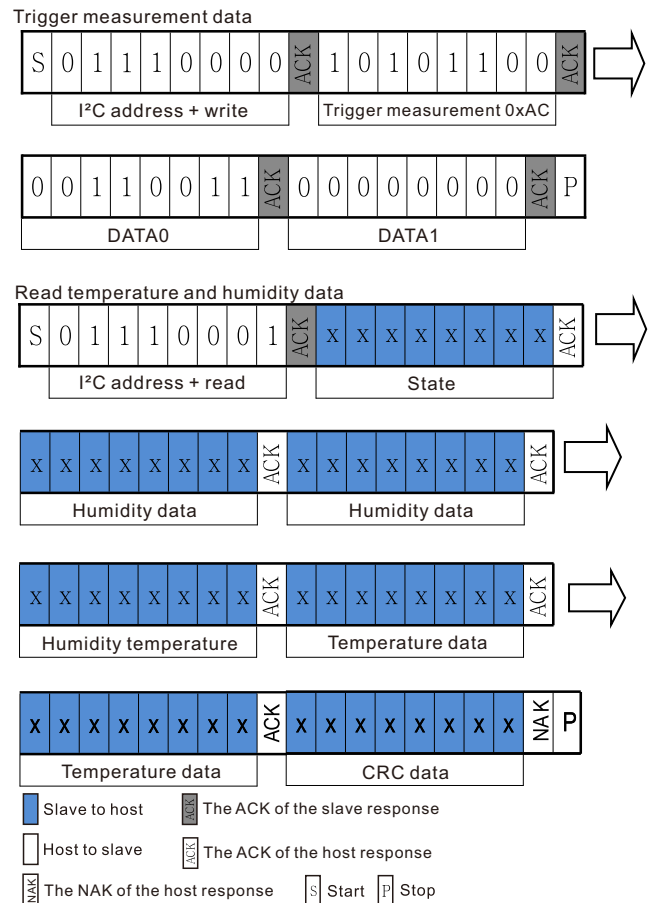

Note: The sensor takes time to collect data. After the host sends out the measurement command (0 x AC), it delays more than 75 milliseconds to read the converted data and judge whether the returned status bits are normal. If the state bit [Bit 7] is 0, the data can be read normally, and 1 represents that the sensor is busy, the host needs to wait for data processing to complete.

5.5 Soft Reset

This command (see Table 11) is used to restart the sensor system without turning the power off and on again. After receiving this command, the sensor system begins to re-initialize and restore the default setting state, and the time required for soft reset does not exceed 20 ms.

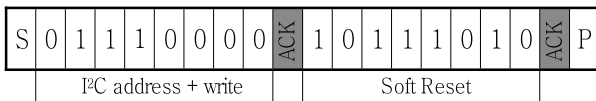

Table 11 Soft Reset– The grey part is controlled by AHT20.

8 Package

AHT20 provides SMD packaging (similar to QFN), which represents a bilateral flat and pin-free package. The sensor chip is made of a copper lead frame coated with Ni/Au. The weight of the sensor is about 19 mg.

8.1 Trace Information

All AHT20 sensors have laser labels on their surfaces. See Figure 20.



Figure 20: Sensor laser label

A label is also attached to the tape, as shown in Figure 21, and other trace information is provided.



Figure 21: Label on the tape

6 Signal Transformation

6.1 Relative humidity transformation

Relative humidity RH can be calculated according to the relative humidity signal SRH output from SDA by the following equation. (The result is expressed in% RH)

$$RH[\%]=\left(\frac{S_{RH}}{2^{20}}\right)*100\%$$

6.2 Temperature transformation

Temperature T can be calculated by substituting the temperature output signal ST into the following formula. (The results are expressed as temperature °C T)

$$T(^{\circ}C)=\left(\frac{S_T}{2^{20}}\right)*200-50$$

7 Environmental stability

If the sensor is used in equipment or machinery, please make sure that it is the same temperature and humidity that the sensor used for measurement and the sensor used for reference that have sensed. If the sensor is placed in the equipment, the reaction time will be prolonged, so it is necessary to ensure that sufficient measurement time is reserved in the programming. The AHT20 sensor is tested according to the enterprise standard of Aosong temperature and humidity sensor. The performance of sensors under other test conditions is not guaranteed and cannot be regarded as a part of sensor performance. Especially for the specific occasions required by users, we do not make any commitments.

8.2 Transport Package

AHT20 is packed in coiled tape and sealed in antistatic ESD bags. The standard packing size is 5000 pieces per roll. For AHT20 packaging, the last 440 mm (55 sensor capacity) and first 200 mm (30 sensor capacity) of each roll are empty packaging.

The package diagram with sensor positioning is shown in Figure 20. The reel is placed in the antistatic pocket.

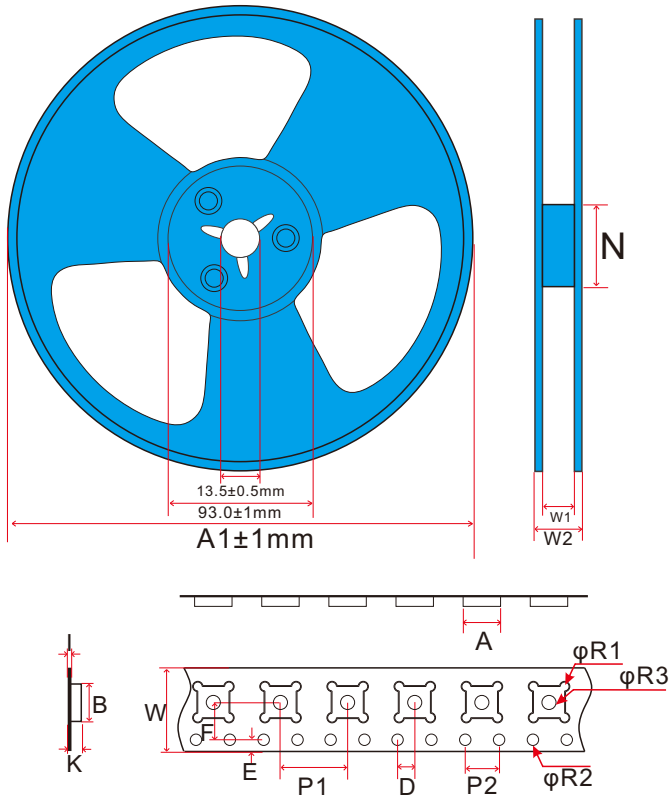

Model	A1	E	W1	W2	N
AHT20	233/330	2	12	16	100

Model	Unit	Tolerance	Quantity	Weight
AHT20	mm	±0.5	5000(AMX)	500/g

Model	A/B	K	W	φR2/φR3	φR1
AHT20	3.25 ^{+0.1} _{-0.0}	1.25 ^{+0.1} _{-0.0}	12.0±0.3	1.50 ^{+0.1} _{-0.0}	0.50 ^{+0.1} _{-0.0}

Model	P1	P2	I	F	E	D
AHT20	8.0±0.1	4.0±0.1	0.3±0.05	5.5±0.1	1.75±0.1	2.0±0.1

Figure 22: Package tape and sensor location diagram

Attention

Warning of personal injury

Do not apply this product to safety protection devices or emergency stop equipment, as well as any other applications that may cause personal injury due to the failure of the product. This product cannot be used unless there is a special purpose or with an authorization to use it. Please refer to the product data sheet and Application guide before installing, processing, using or maintaining the product. Failure to comply with this recommendation may result in death and serious bodily injury.

If the Buyer intends to purchase or use the Aosong products without any application license and authorization, the buyer shall bear all compensation for personal injury and death resulting therefrom, and shall not claim for compensation including various costs, compensation fees, lawyers, etc. Expenses and so on with the managers and employees of Aosong Company, as well as subsidiaries, agents, distributors, etc.

ESD Protection

Due to the inherent component design, it is sensitive to static electricity. In order to prevent the damage and the reduction of the product's performance caused by static electricity, the necessary anti-static measures should be taken when applying this product.

Quality Assurance

Our company provides 12-month (1-year) quality assurance for buyers of its products (calculated from the date of delivery) based on the technical specifications in the data manual of the product published by Aosong. If the product is found to be defective under warranty, our company will provide free maintenance or replacement. Users need to satisfy the following conditions:

- Notify our company in writing within 14 days after the defect is found
- The defect of this product will help to find out the deficiency in design, material and technology of our product.
- The product should be sent back to our company at the buyer's expense.
- The product should be under warranty.

Our company is only responsible for the defective products which are used in the occasions that meet the technical requirements of the product. Our company makes no warranties or written representations regarding the use of its products in special application occasions.

At the same time, the company does not make any commitment to the reliability of the products applied to products or circuits.

Copyright ©2019, ASAIR®