



PARA LIGHT ELECTRONICS CO., LTD.

11F., No. 8, Jiankang Rd., Zhonghe Dist., New Taipei City 235, Taiwan,
Tel: 886-2-2225-3733 Fax: 886-2-2225-4800
E-mail: para@para.com.tw <http://www.para.com.tw>

DATA SHEET

PART NO.: L-C191TBCT

REV: C / 1

CUSTOMER'S APPROVAL : _____

DCC : _____

DRAWING NO. : DS-74-03-0009

DATE : 2016-4-21

PAGE 1 of 14



SURFACE MOUNT DEVICE LED

Part No. : L-C191TBCT

REV:C / 1

● PACKAGE OUTLINE DIMENSIONS

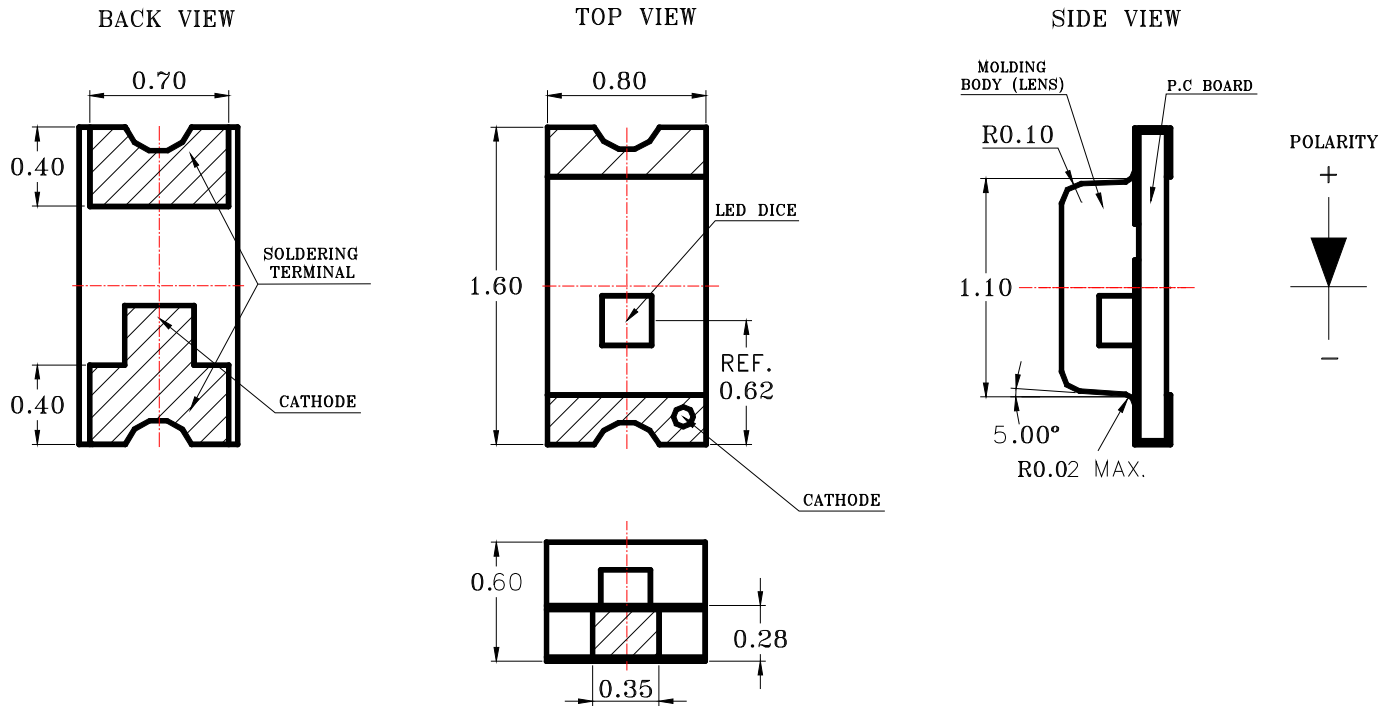

Notes:

1. All dimensions are in millimeters.
2. Tolerance is $\pm 0.1\text{mm}$ (.004") unless otherwise noted.

● Features

- * Top view, wide view angle, single color Chip LED.
- * Package in 8mm tape on 7" diameter reels.
- * Compatible with automatic Pick & Place equipment.
- * Compatible with Infrared and Wave soldering reflow solder processes.
- * EIA STD package.
- * I.C. compatible.
- * Pb free product.
- * Meet RoHS Green Product.



SURFACE MOUNT DEVICE LED

Part No. : L-C191TBCT

REV:C / 1

● CHIP MATERIALS

- * Dice Material : InGaN
- * Light Color : Super Blue
- * Lens Color : Water Clear

● Absolute Maximum Ratings(Ta=25°C)

Symbol	Parameter	Rating	Unit
PD	Power Dissipation	100	mW
IPF	Peak Forward Current (1/10 Duty Cycle, 0.1ms Pulse Width)	100	mA
IF	Continuous Forward Current	25	mA
-	De-rating Linear From 25°C	0.25	mA/°C
VR	Reverse Voltage	5	V
ESD	Electrostatic Discharge Threshold(HBM)Note A	1000	V
Topr	Operating Temperature Range	-40 ~ +85	°C
Tstg	Storage Temperature Range	-40 ~ +85	°C

Note A :

HBM : Human Body Model. Seller gives no other assurances regarding the ability of to withstand ESD.

● Electro-Optical Characteristics(Ta=25°C)

Parameter	Symbol	Min.	Typ.	Max.	Unit	Test Condition
Luminous Intensity	IV	11.2	20		mcd	IF=5mA
Viewing Angle	2 θ 1/2		130		deg	Note 2
Peak Emission Wavelength	λ p		468		nm	Measurement @Peak
Dominant Wavelength	λ d		470		nm	IF=5mA
Spectral Line Half-Width	Δ λ		25		nm	
Forward Voltage	VF		2.8	3.1	V	IF = 5mA
Reverse Current	IR			50	μ A	VR = 5V



SURFACE MOUNT DEVICE LED

Part No. : L-C191TBCT

REV:C / 1

● Bin Code List

Luminous Intensity(IV), Unit:mcd@5mA		
Bin Code	Min	Max
L1	11.2	14
L2	14	18
M1	18	22.4
M2	22.4	28
N1	28	35.5

Forward Voltage(VF), Unit:V@5mA		
Bin Code	Min	Max
J7	2.60	2.75
J8	2.75	2.90
J9	2.90	3.05

Tolerance of each bin are $\pm 15\%$

Tolerance of each bin are ± 0.1 Volt

Dominant Wavelength (Hue),Unit: nm@5mA		
Bin Code	Min	Max
AC	465	470
AD	470	475

Tolerance of each bin are ± 1 nm

Notes:

1. Luminous intensity is measured with a light sensor and filter combination that proximities the CIE eye-response curve.
2. $\theta 1/2$ is the off-axis angle at which the luminous intensity is half the axial luminous intensity.
3. The dominant wavelength λd is derived from the CIE chromaticity diagram and represents the single wavelength which defines the color of the device.
4. Caution in ESD :
Static Electricity and surge damages the LED. It is recommended use a wrist band or anti-electrostatic glove when handling the LED. All devices, equipment and machinery must be properly grounded.
5. Major standard testing equipment by “Instrument System” Model : CAS140B Compact Array Spectrometer and “KEITHLEY” Source Meter Model : 2400.



SURFACE MOUNT DEVICE LED

Part No. : L-C191TBCT

REV:C / 1

● Typical Electro-Optical Characteristics Curves

(25°C Ambient Temperature Unless Otherwise Noted)

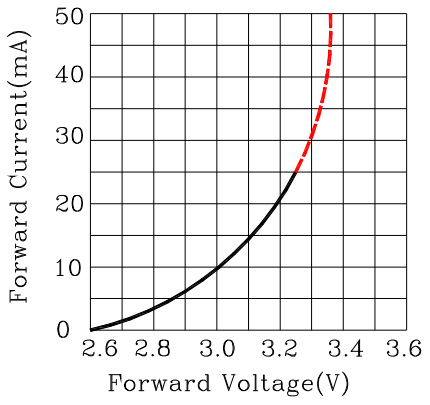

Fig.2 Forward Current vs.Forward Voltage

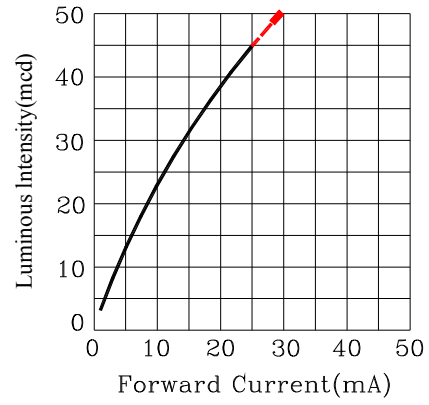

Fig.3 Luminous Intensity vs.Forward Current

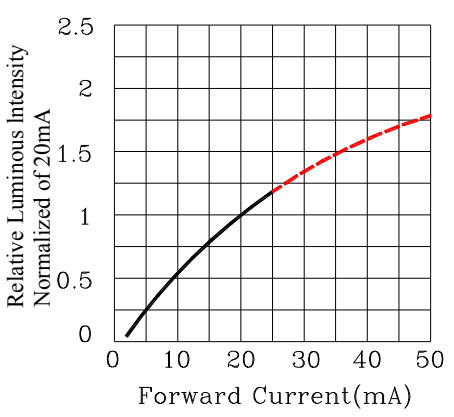

Fig.4 Relative Luminous Intensity vs.Forward Current

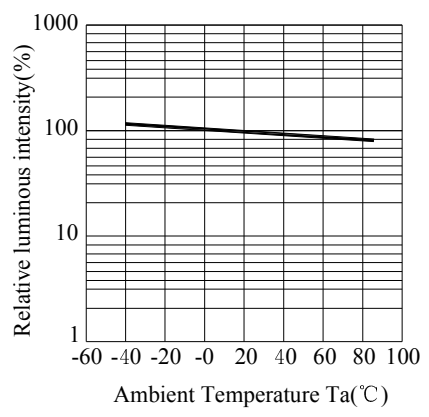

Fig.5 Luminous Intensity vs.Ambient Temperature

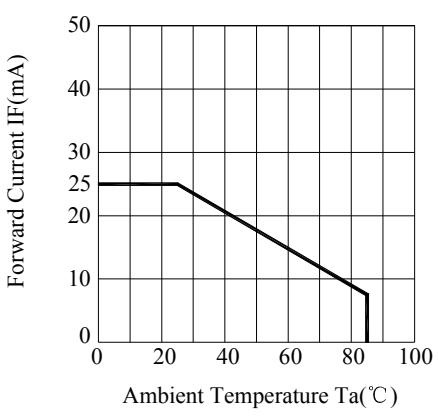

Fig.6 Forward Current Derating Curve

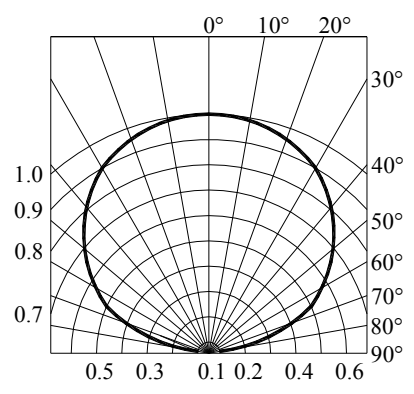

Fig.7 Relative Intensity vs.Angle



SURFACE MOUNT DEVICE LED

Part No. : L-C191TBCT

REV:C / 1

● Label Explanation



ITEM CODE:PARRA LIGHT
PART NO: L-C191TBCT

IV --- Luminous Intensity Code

LOT NO: EM S L 12 09 0110
 A B C D E F

- A---EM: Emos Code
- B---S:SMD
- L---Local
- D---Year
- E---Month
- F---SPEC.

PACKING QUANTITY OF BAG :

- 3000pcs for 150、170、110、155、115 series
- 4000pcs for 191 series
- 5000pcs for 192 series

DATE CODE: 2012 09 10
 G H I

- G--- Year
- H--- Month
- I --- Day



SURFACE MOUNT DEVICE LED

Part No. : L-C191TBCT

REV:C / 1

● Typical Electro-Optical Characteristics Curves

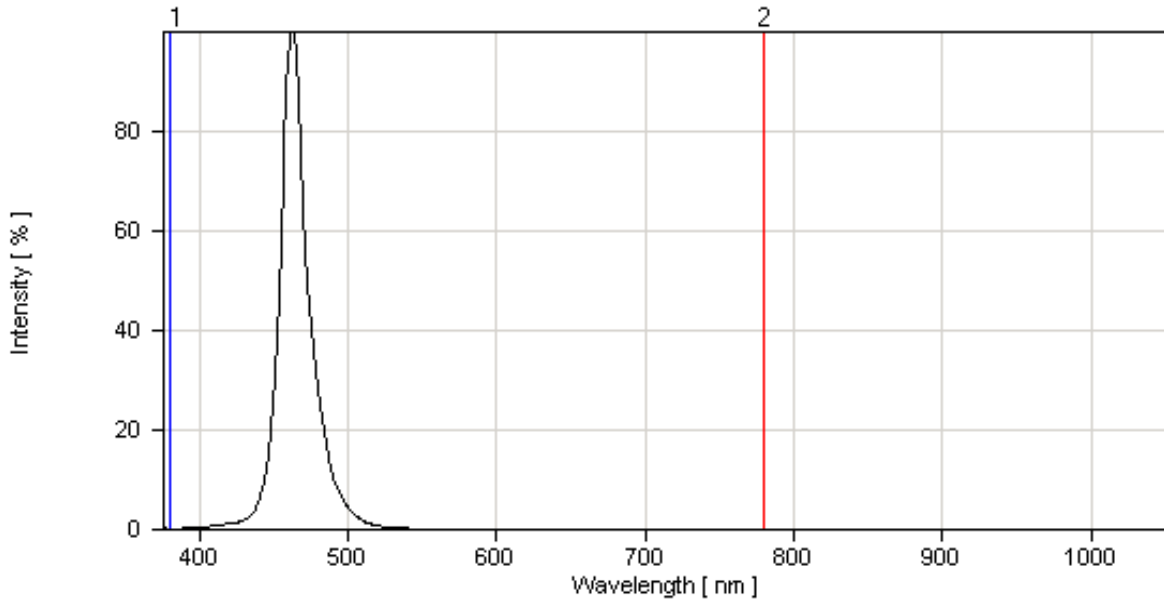
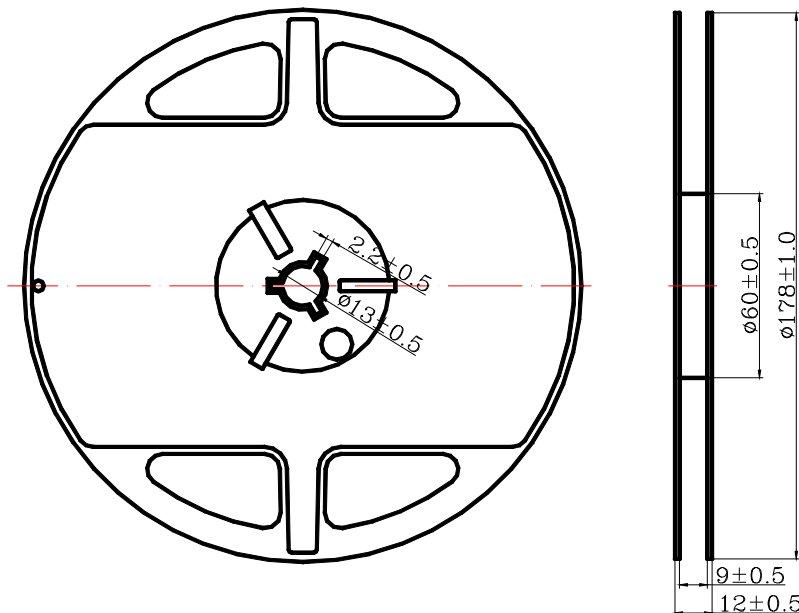

Fig.1 Relative Intensity vs. Wavelength

● Reel Dimensions



Notes:

1. Taping Quantity : 4000pcs max
2. The tolerances unless mentioned is $\pm 0.1\text{mm}$, Angle $\pm 0.5^\circ$, Unit : mm.



SURFACE MOUNT DEVICE LED

Part No. : L-C191TBCT

REV:C / 1

● Package Dimensions Of Tape And Reel

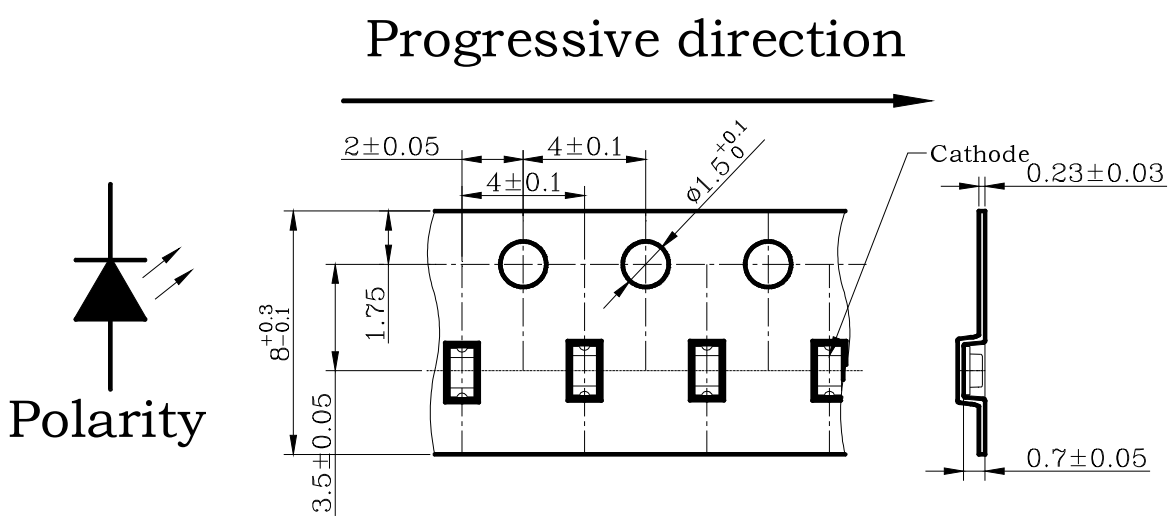

Notes: All dimensions are in millimeters.

Moisture Resistant Packaging

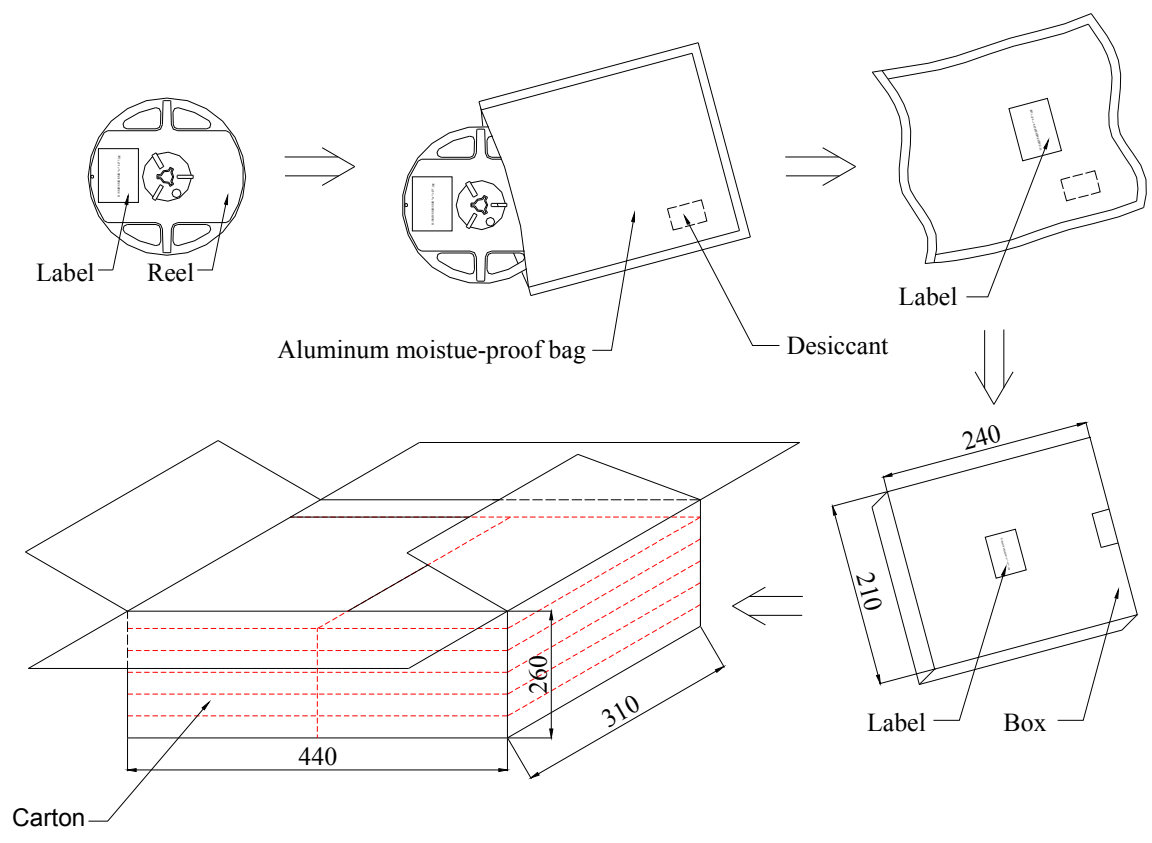

Notes : One reel in a bag, six bag in a inner box, six inner boxes in a carton. Unit : mm.



SURFACE MOUNT DEVICE LED

Part No. : L-C191TBCT

REV:C / 1

● Cleaning

- * If cleaning is required , use the following solutions for less than 1 minute and less than 40°C.
- * Appropriate chemicals: Ethyl alcohol and isopropyl alcohol.
- * Effect of ultrasonic cleaning on the LED resin body differs depending on such factors as the oscillator output, size of PCB and LED mounting method. The use of ultrasonic cleaning should be enforced at proper output after confirming there is no problem.

● Suggest Soldering Pad Dimensions

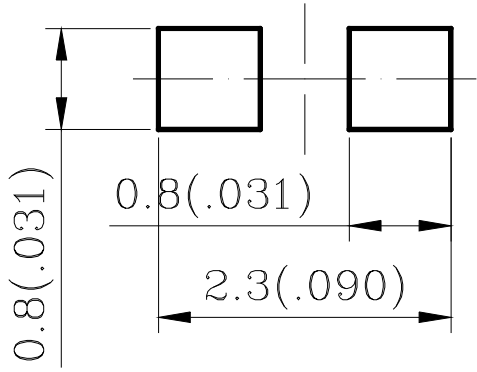

Direction of PWB camber
and go to reflow furnace



SURFACE MOUNT DEVICE LED

Part No. : L-C191TBCT

REV:C / 1

- Suggest Sn/Pb IR Reflow Soldering Profile Condition:

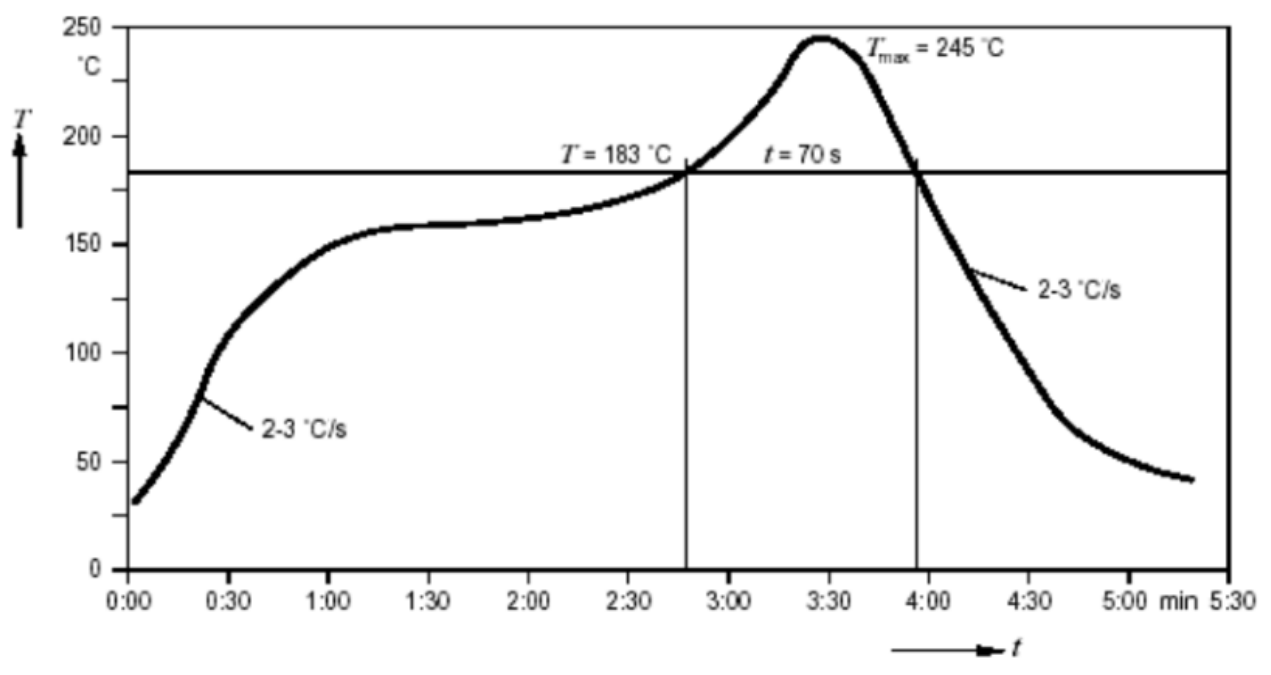

- Suggest Pb-Free IR Reflow Soldering Profile Condition:

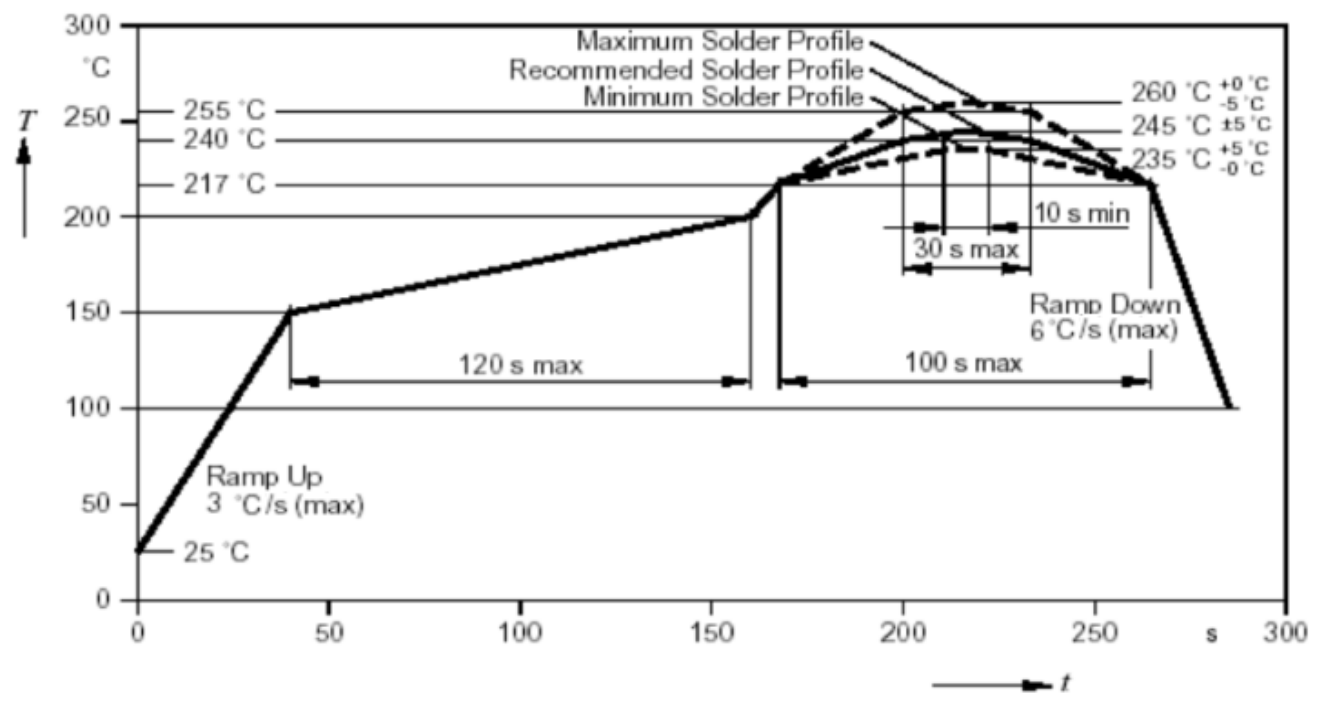



SURFACE MOUNT DEVICE LED

Part No. : L-C191TBCT

REV:C / 1

CAUTIONS

1. Application Limitation :

The LED's described here are intended to be used for ordinary electronic equipment (such as office equipment, communication equipment and household application). Consult PARA's sales in advance for information on application in which exceptional quality and reliability are required, particularly when the failure or malfunction of the LED's may directly jeopardize life or health (such as airplanes, automobiles, traffic control equipment, life support system and safety devices).

2. Storage :

Do not open moisture proof bag before the products are ready to use.

Before opening the package: The LEDs should be kept at 30°C or less and 90%RH or less.

After opening the package: The LED's floor life is 1 year under 30°C or less and 60% RH or less. If unused LEDs remain, it should be stored in moisture proof packages.

If the moisture absorbent material (silica gel) has faded away or the LEDs have exceeded the storage time, baking treatment should be performed using the following conditions.

Baking treatment: 60±5°C for 24 hours.

3. Soldering

Do not apply any stress to the lead frame during soldering while the LED is at high temperature.

Recommended soldering condition.

Reflow Soldering :

Pre-heat 120~150°C, 120sec. MAX., Peak temperature : 240°C Max. Soldering time : 10 sec Max.

Soldering Iron : (Not recommended)

Temperature 300°C Max., Soldering time : 3 sec. Max.(one time only), power dissipation of iron :



SURFACE MOUNT DEVICE LED

Part No. : L-C191TBCT

REV:C / 1

20W Max. use SN60 solder of solder with silver content and don't to touch LED lens when soldering.

Wave soldering :

Pre-heat 100°C Max, Pre-heat time 60 sec. Max, Solder wave 260°C Max, Soldering time 5 sec. Max. preformed consecutively cooling process is required between 1st and 2nd soldering processes.

4. Lead-Free Soldering

For Reflow Soldering :

- 1、Pre-Heat Temp:150-180°C,120sec.Max.
- 2、Soldering Temp:Temperature Of Soldering Pot Over 230°C,40sec.Max.
- 3、Peak Temperature:260°C、5sec.
- 4、Reflow Repetition:2 Times Max.
- 5、Suggest Solder Paste Formula 93.3 Sn/3.1 Ag/3.1 Bi /0.5 Cu

For Soldering Iron (Not Recommended) :

- 1、Iron Tip Temp:350°C Max.
- 2、Soldering Iron:30w Max.
- 3、Soldering Time:3 Sec. Max. One Time.

For Dip Soldering :

- 1、Pre-Heat Temp:150°C Max. 120 Sec. Max.
- 2、Bath Temp:265°C Max.
- 3、Dip Time:5 Sec. Max.

5. Drive Method

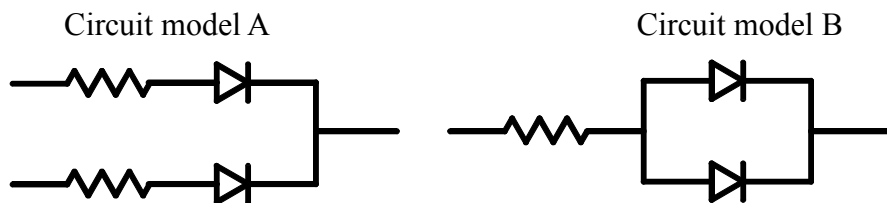

(A)Recommended circuit.

(B)The difference of brightness between LED's could be found due to the Vf-If characteristics of LED.



SURFACE MOUNT DEVICE LED

Part No. : L-C191TBCT

REV:C / 1

6. Reliability Test

Classification	Test Item	Test Condition	Reference Standard
Endurance Test	Operation Life	Ta= Under Room Temperature As Per Data Sheet Maximum Rating *Test Time= 1000HRS (-24HRS,+72HRS)*@20mA.	MIL-STD-750D:1026 (1995) MIL-STD-883D:1005 (1991) JIS C 7021:B-1 (1982)
	High Temperature High Humidity Storage	IR-Reflow In-Board, 2 Times Ta= 65±5°C, RH= 90~95% *Test Time= 1000HRS±2HRS	MIL-STD-202F:103B(1980) JIS C 7021:B-11(1982)
	High Temperature Storage	Ta= 105±5°C Test Time= 1000HRS (-24HRS,72HRS)	MIL-STD-883D:1008 (1991) JIS C 7021:B-10 (1982)
	Low Temperature Storage	Ta= -55±5°C *Test Time=1000HRS (-24HRS,72HRS)	JIS C 7021:B-12 (1982)
Environmental Test	Temperature Cycling	105±5°C -55±5°C 10mins 10mins 100 Cycles	MIL-STD-202F:107D (1980) MIL-STD-750D:1051(1995) MIL-STD-883D:1010 (1991) JIS C 7021:A-4(1982)
	Thermal Shock	IR-Reflow In-Board, 2 Times 105±5°C -55°C±5°C 10mins 10mins 100 Cycles	MIL-STD-202F:107D(1980) MIL-STD-750D:1051(1995) MIL-STD-883D:1011 (1991)
	Solder Resistance	Tsol= 260 ± 5°C Dwell Time= 10 ± 1sec	MIL-STD-202F:210A(1980) MIL-STD-750D:2031(1995) JIS C 7021:A-1(1982)
	Solder ability	Tsol= 235 ± 5°C Immersion time 2±0.5 sec Immersion rate 25±2.5 mm/sec Coverage ≥ 95% of the dipped surface	MIL-STD-202F:208D(1980) MIL-STD-750D:2026(1995) MIL-STD-883D:2003(1991) IEC 68 Part 2-20 JIS C 7021:A-2(1982)

7. Others:

The appearance and specifications of the product may be modified for improvement without notice.



SURFACE MOUNT DEVICE LED

Part No. : L-C191TBCT

REV:C / 1

● PART NO. SYSTEM :
L - C 1 9 1 X C X X - X X X X

XXXX : Special specification for customer

T : Taping for 7 inch reel
TC : Taping for 13 inch reel
TH : IV half binning
TP : Wavelength binning

Lens color
C : Water Clear
W : White Diffused
T : Color Transparent
D : Color Diffused

G : Gap 570nm Green
Y : GaAsp 585 nm Yellow
E : GaAsp 620 nm Orange
SR : GaAlAs 634 nm Red
KG : AllnGap 570nm Super Green
KY : AllnGap 590nm Super Yellow
KF : AllnGap 605nm Super Amber
KR : AllnGap 630 nm Super Red
LB/TB : InGaN 470nm Blue
LG : InGaN 525nm Green.....

0 : Single chip
1/2 : Super thin single chip
5/6 : Dual chip
F : Three chip(Full color)

150 : 1206 1.1T Type
170 : 0805 0.8T Type
191 : 0603 0.6T Type
192 : 0603 0.4T Type
110 : 1206 1.0T Type

C : Top View Type
S : Side View Type