

Data sheet | Item number: 2060-951/028-000

Board-to-Board Link; Pin spacing 4 mm; 1-pole; Length: 28 mm

[www.wago.com/2060-951/028-000](http://www.wago.com/2060-951/028-000)

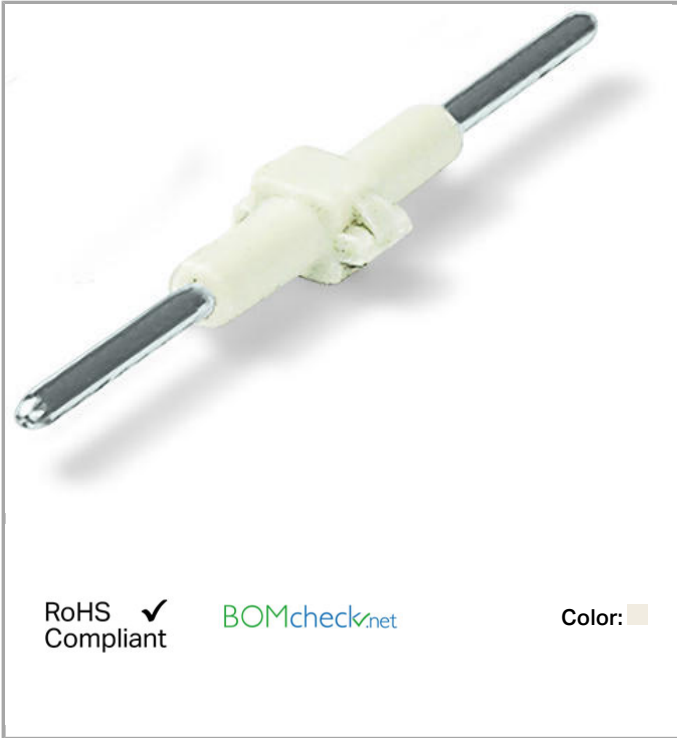

RoHS  
Compliant

BOMcheck.net

Color:

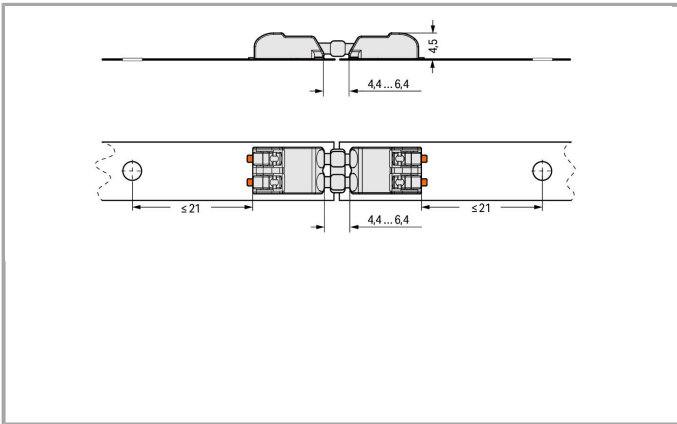
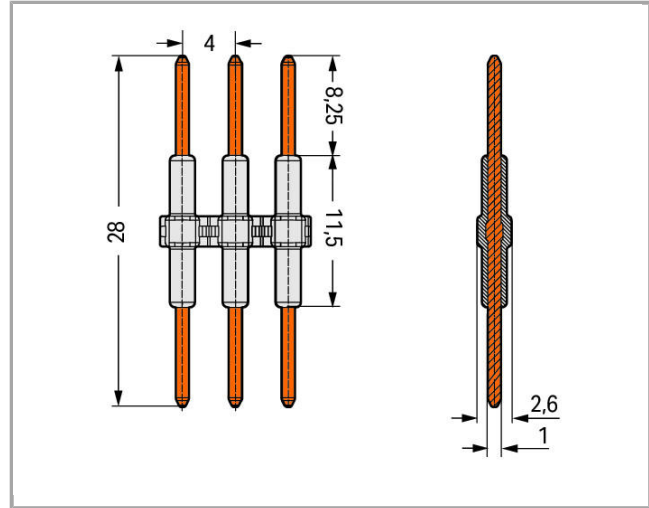

### Item description

- Board-to-board link simplifies in-line assembly of LED modules
- Easy push-in termination and disconnection without push-button actuation

Recommendation:

Only suitable for 2060-45x, not for 2060-40x.

## Data

### Electrical data

#### Ratings per IEC/EN 60664-1

Rated voltage (III / 3)	63 V
Rated impulse voltage (III / 3)	2.5 kV
Rated voltage (III / 2)	160 V
Rated impulse voltage (III / 2)	2.5 kV
Rated voltage (II / 2)	320 V
Rated impulse voltage (II / 2)	2.5 kV
Rated current	9 A

#### Approvals per UL 1977

Rated voltage per UL 1977 (factory wiring only)	250 V
Rated current per UL 1977 (factory wiring only)	9 A

### Connection data

No. of poles	1
Total number of potentials	1
Number of connection types	1

### Geometrical Data

Pin spacing	4 mm / 0.157 inch
Width	3.4 mm / 0.134 inch
Height	2.6 mm / 0.102 inch
Depth	28 mm / 1.102 inch

### Mechanical data

Mating cycles	10
Number of mating cycles	max. 10 mating cycles

### Material Data

Color	white
Material group	I

Insulating material	Polyamide 66 (PA 66)
Flammability class per UL94	V0
Contact material	Copper alloy
Contact plating	silver-plated
Fire load	0 MJ
Weight	0.23 g

### Environmental Requirements







Limit temperature range	-60 ... +105 °C
-------------------------	-----------------

### Commercial data

Country of origin	CN
GTIN	4055143303880
Customs Tariff No.	85369010000

### Approvals / Certificates

#### Country specific Approvals

Logo	Approval	Additional Approval Text	Certificate name
	CCA DEKRA Certification B.V.	EN 60947	NTR NL- 7724
	CCA DEKRA Certification B.V.	EN 60998	NTR NL 7725
	CCA DEKRA Certification B.V.	EN 60998	71-107169
	CCA DEKRA Certification B.V.	EN 60838	NTR NL 2168246
	KEMA/KEUR DEKRA Certification B.V.	EN 60947	71-107168
	KEMA/KEUR DEKRA Certification B.V.	EN 60838	2168246.01



#### UL-Approvals

Logo	Approval	Additional Approval Text	Certificate name
	cURus Underwriters Laboratories Inc.	UL 1977	E45171

#### Downloads

##### Documentation

##### Additional Information

pdf  
3.6 MB [Download](#)

#### CAD/CAE - Smart Data

##### CAD data

3D Download 2060-951/028-000 [URL](#) [Download](#)

Subject to changes.