

40x40x28 mm

San Ace 40 9GAX type Low Power Consumption Fan 



General Specifications

- Material Frame: Plastic (Flammability: UL 94V-0), Impeller: Plastic (Flammability: UL 94V-0)
- Expected life See the table below. (L10 life: 90% survival rate for continuous operation in free air at 60°C, rated voltage)
Expected life at 40°C is for reference only.
- Motor protection function Locked rotor burnout protection, Reverse polarity protection
For details, please refer to p. 599.
- Dielectric strength 50/60 Hz, 500 VAC, for 1 minute (between lead wire conductors and frame)
- Insulation resistance 10 MΩ or more with a 500 VDC megger (between lead wire conductors and frame)
- Sound pressure level (SPL) At 1 m away from the air inlet
- Storage temperature -30 to +70°C (Non-condensing)
- Lead wire ⊕Red ⊖Black (Sensor) Yellow (Control) Brown
- Mass 53 g

Specifications

The models listed below **have ribs and pulse sensors with PWM control function**. For models without ribs, append "1" to the end of model numbers.

Model no.	Rated voltage [V]	Operating voltage range [V]	PWM duty cycle [%]	Rated current [A]	Rated input [W]	Rated speed [min ⁻¹]	Max. airflow [m ³ /min] [CFM]	Max. static pressure [Pa] [inchH ₂ O]	SPL [dB (A)]	Operating temperature [°C]	Expected life [h]
9GAX0412P3S001	12	10.8 to 12.6	100	1.3	15.6	25000	0.9 31.8	1000 4.02	64	-20 to +60	30000/60°C (53000/40°C)
			20	0.07	0.84	4400	0.155 5.5	32 0.125	21.5		
9GAX0412P3S003			100	1.3	15.6	25000	0.9 31.8	1000 4.02	64		
10.8 to 13.2		0	0.11	1.32	7800	0.26 9.2	87 0.35	38			
		9GAX0412P3K001	100	0.92	11.04	22000	0.81 28.6	800 3.21	61		
		20	0.07	0.84	4200	0.15 5.3	28 0.11	21			
9GAX0412P3K003	100	0.92	11.04	22000	0.81 28.6	800 3.21	61				
	0	0.1	1.2	6500	0.24 8.5	70 0.28	32				

* PWM input frequency is 25 kHz; models without specifications at 0% PWM duty cycle have zero fan speed at 0%.

Note: The  mark indicates Short LeadTime Service applicable models. See p. 654 for details.

Airflow - Static Pressure Characteristics / PWM Duty - Speed Characteristics Example

9GAX0412P3S001 With pulse sensor with PWM control function

PWM duty cycle

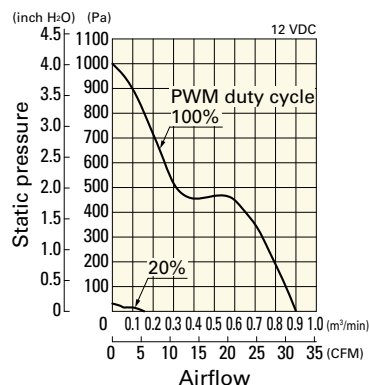

Operating voltage range

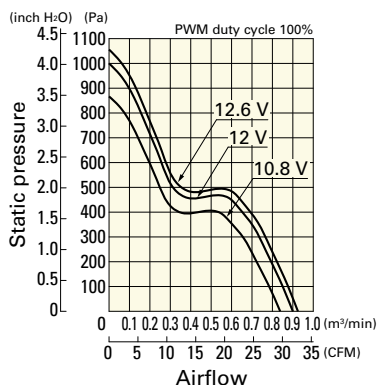

PWM duty - Speed characteristics example

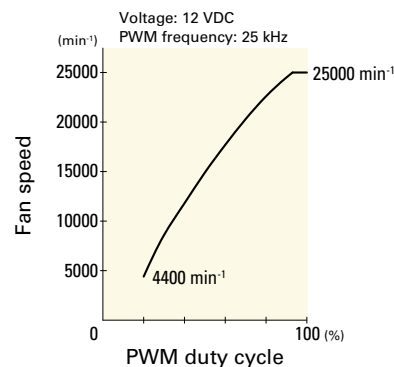

Airflow - Static Pressure Characteristics / PWM Duty - Speed Characteristics Example

9GAX0412P3S003 With pulse sensor with PWM control function

PWM duty cycle

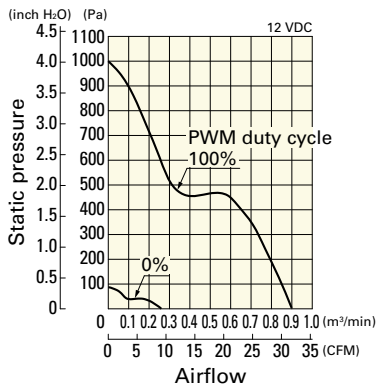

Operating voltage range

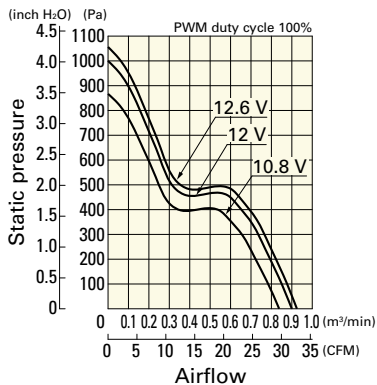

PWM duty - Speed characteristics example

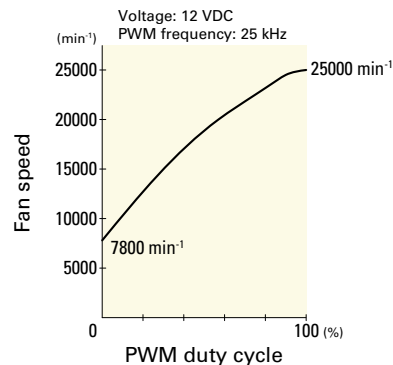

9GAX0412P3K001 With pulse sensor with PWM control function

PWM duty cycle

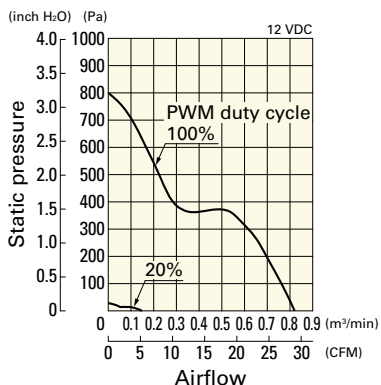

Operating voltage range

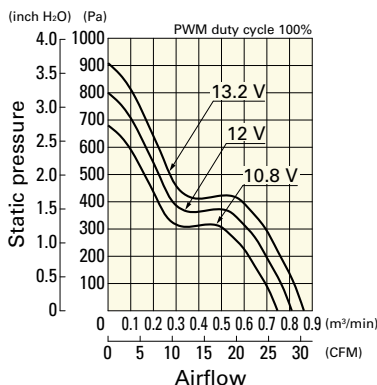

PWM duty - Speed characteristics example

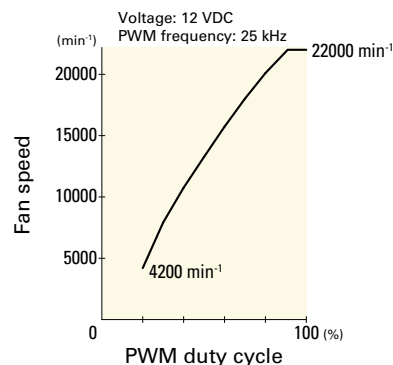

9GAX0412P3K003 With pulse sensor with PWM control function

PWM duty cycle

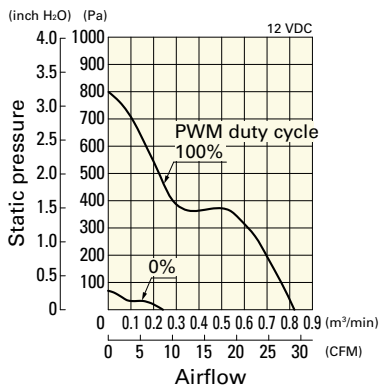

Operating voltage range

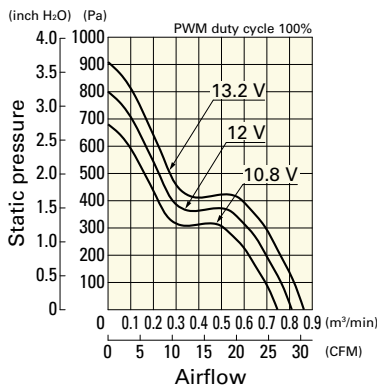

PWM duty - Speed characteristics example

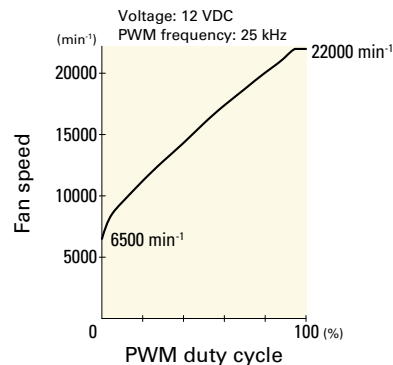

Dimensions (unit: mm) (With ribs)

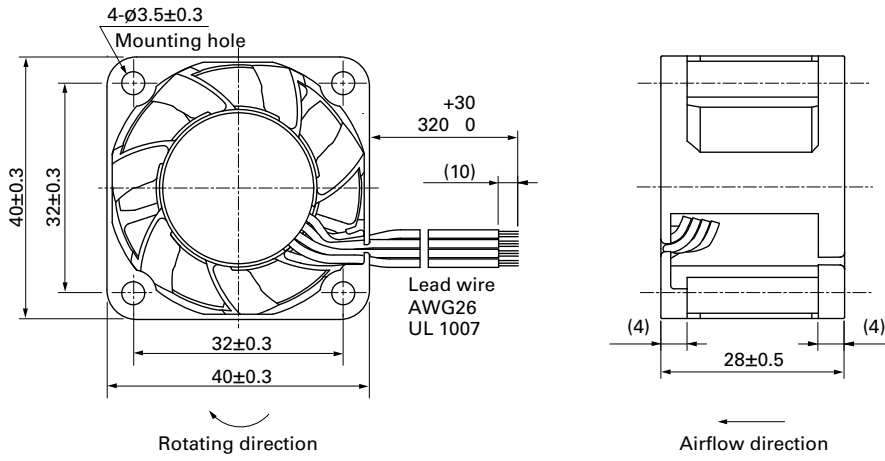

Reference Dimensions of Mounting Holes and Vent Opening (unit: mm)

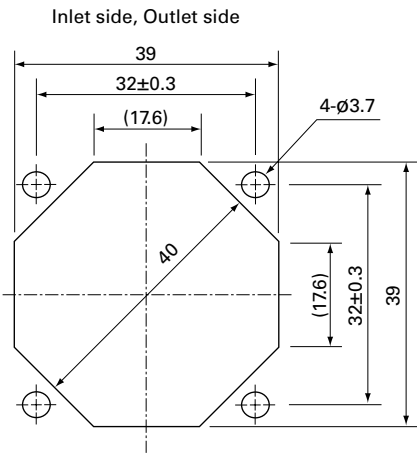

Options

Finger guards

page: p. 584

Model no.: 109-059, 109-059H