



# 40x40x28 mm

**San Ace 40 9GA** type Low Power Consumption Fan

## General Specifications

- Material ..... Frame: Plastic (Flammability: UL 94V-0), Impeller: Plastic (Flammability: UL 94V-0)
- Expected life ..... See the table below. (L10 life: 90% survival rate for continuous operation in free air at 60°C, rated voltage)  
Expected life at 40°C is for reference only.
- Motor protection function ..... Locked rotor burnout protection, Reverse polarity protection  
For details, please refer to p. 599.
- Dielectric strength ..... 50/60 Hz, 500 VAC, for 1 minute (between lead wire conductors and frame)
- Insulation resistance ..... 10 MΩ or more with a 500 VDC megger (between lead wire conductors and frame)
- Sound pressure level (SPL) ..... At 1 m away from the air inlet
- Storage temperature ..... -30 to +70°C (Non-condensing)
- Lead wire ..... ⊕Red ⊖Black (Sensor) Yellow (Control) Brown
- Mass ..... 53 g

## Specifications

The models listed below **have ribs and pulse sensors with PWM control function**. For models without ribs, append "1" to the end of model numbers.

Model no.	Rated voltage [V]	Operating voltage range [V]	PWM duty cycle* [%]	Rated current [A]	Rated input [W]	Rated speed [min <sup>-1</sup> ]	Max. airflow [m <sup>3</sup> /min] [CFM]	Max. static pressure [Pa] [inchH <sub>2</sub> O]	SPL [dB (A)]	Operating temperature [°C]	Expected life [h]				
▶▶▶ 9GA0412P3K01	12	10.8 to 13.2	100	0.92	11.04	22000	0.81 28.6	799 3.21	61	-20 to +60	30000/60°C (53000/40°C)				
			0	0.1	1.2	6500	0.23 8.12	68 0.27	32						
▶▶▶ 9GA0412P3J01			100	0.49	5.88	18000	0.67 23.7	535 2.15	54						
			0	0.05	0.6	4500	0.16 5.7	33 0.13	22						
▶▶▶ 9GA0412P3G01			100	0.39	4.68	16500	0.61 21.5	450 1.81	53						
			0	0.05	0.6	4500	0.16 5.7	33 0.13	22						
▶▶▶ 9GA0412P3H01			100	0.28	3.36	14500	0.54 19.1	347 1.39	50						
			0	0.04	0.48	3500	0.13 4.6	20 0.08	17						
▶▶▶ 9GA0412P3M01			100	0.21	2.52	12500	0.46 16.2	258 1.04	47						
			0	0.04	0.48	3500	0.13 4.6	20 0.08	17						
▶▶▶ 9GA0424P3J001			24	21.6 to 26.4	100	0.27	6.48	18000	0.67 23.7			535 2.15	54	-20 to +70	40000/60°C (70000/40°C)
▶▶▶ 9GA0424P3G001					100	0.22	5.28	16500	0.61 21.5			450 1.81	53		
▶▶▶ 9GA0424P3H001	100	0.16			3.84	14500	0.54 19.1	347 1.39	50						
▶▶▶ 9GA0424P3M001	100	0.11			2.64	12500	0.46 16.2	258 1.04	47						

\* PWM input frequency is 25 kHz; models without specifications at 0% PWM duty cycle have zero fan speed at 0%.

Note 1: Sensor and control options are available for selection. Refer to the table on p. 628.

Note 2: The ▶▶▶ mark indicates Short LeadTime Service applicable models. See p. 654 for details.

## Airflow - Static Pressure Characteristics / PWM Duty - Speed Characteristics Example

**9GA0412P3K01** With pulse sensor with PWM control function

PWM duty cycle

Operating voltage range

PWM duty - Speed characteristics example

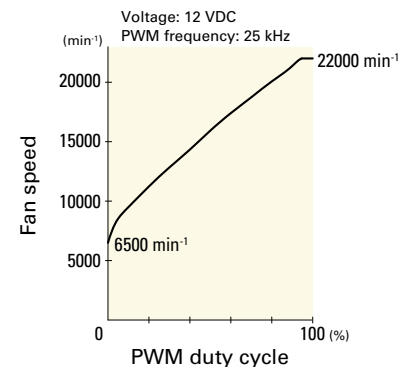
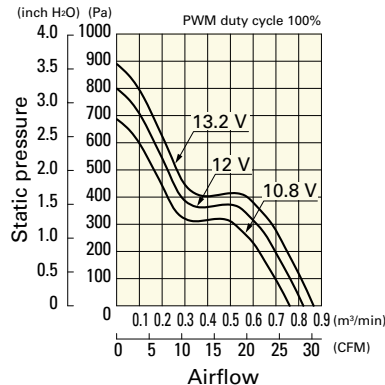
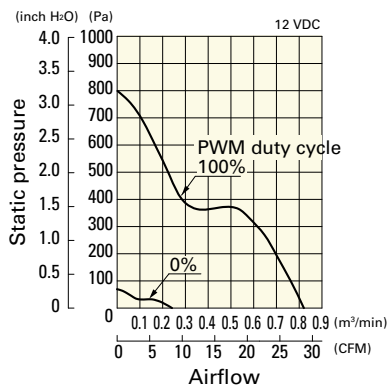

**Airflow - Static Pressure Characteristics / PWM Duty - Speed Characteristics Example**

**9GA0412P3J01** With pulse sensor with PWM control function

PWM duty cycle

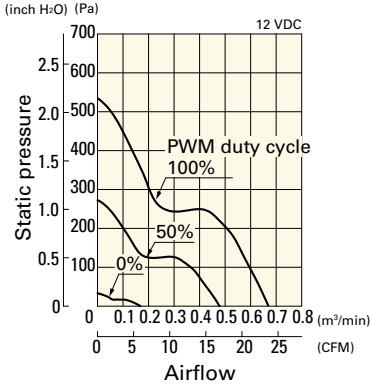

Operating voltage range

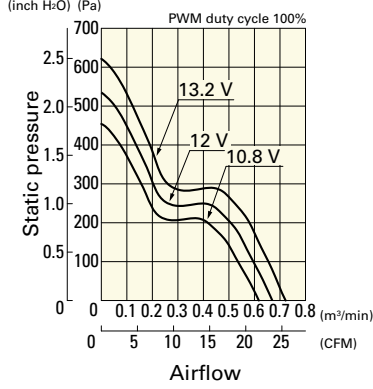

PWM duty - Speed characteristics example

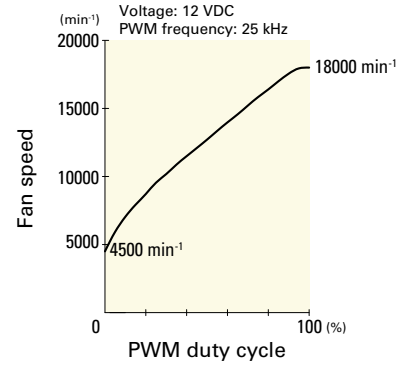

**9GA0412P3G01** With pulse sensor with PWM control function

PWM duty cycle

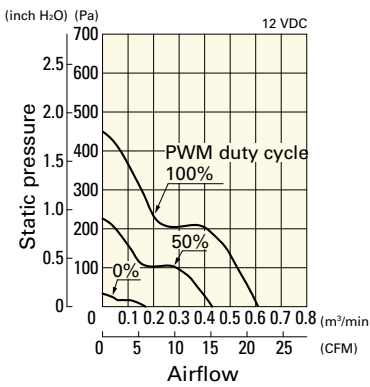

Operating voltage range

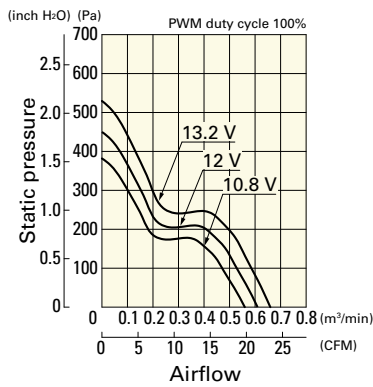

PWM duty - Speed characteristics example

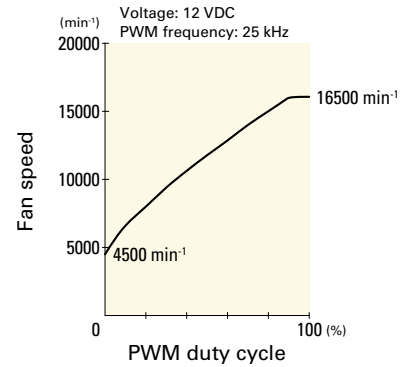

**9GA0412P3H01** With pulse sensor with PWM control function

PWM duty cycle

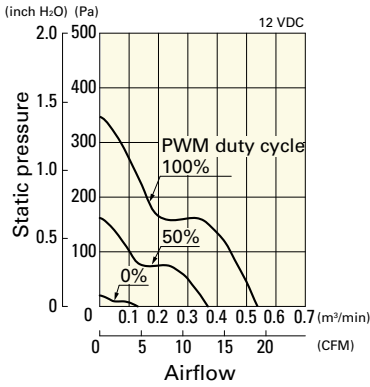

Operating voltage range

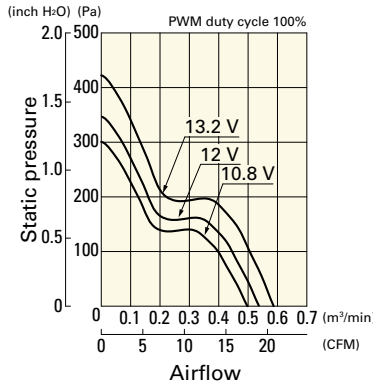

PWM duty - Speed characteristics example

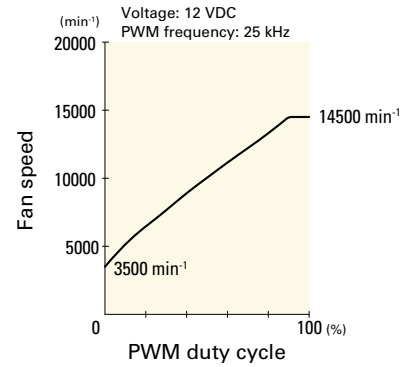

**9GA0412P3M01** With pulse sensor with PWM control function

PWM duty cycle

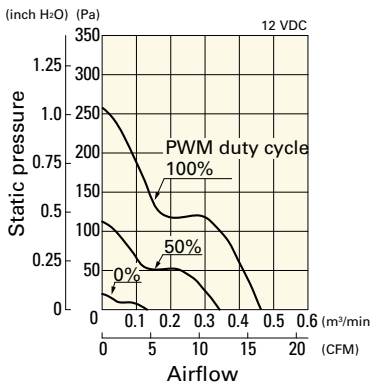

Operating voltage range

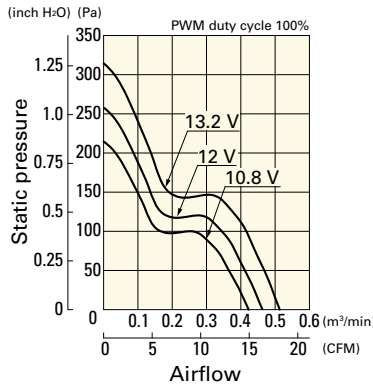

PWM duty - Speed characteristics example

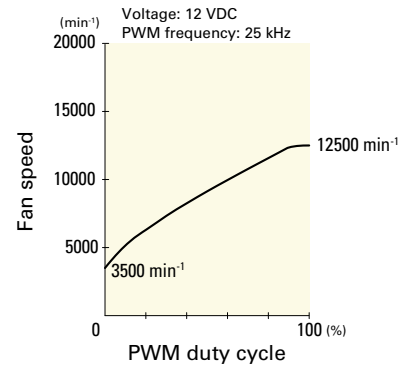

**Airflow - Static Pressure Characteristics / PWM Duty - Speed Characteristics Example**

**9GA0424P3J001** With pulse sensor with PWM control function

PWM duty cycle

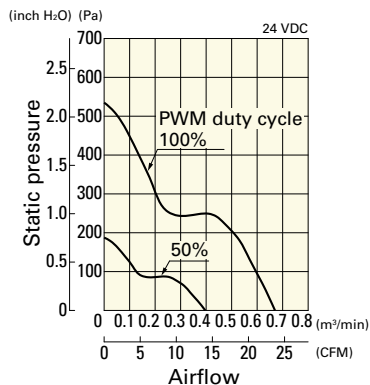

Operating voltage range

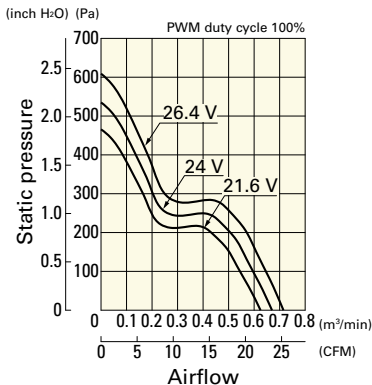

PWM duty - Speed characteristics example

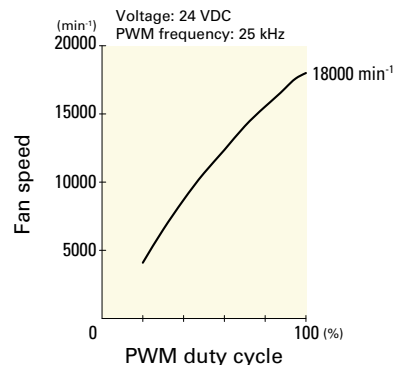

**9GA0424P3G001** With pulse sensor with PWM control function

PWM duty cycle

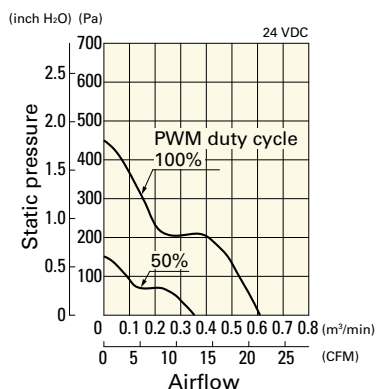

Operating voltage range

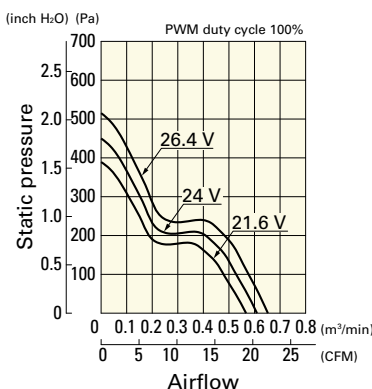

PWM duty - Speed characteristics example

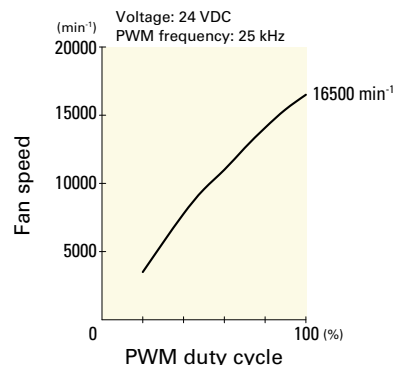

**9GA0424P3H001** With pulse sensor with PWM control function

PWM duty cycle

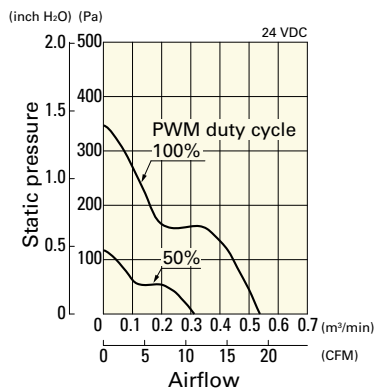

Operating voltage range

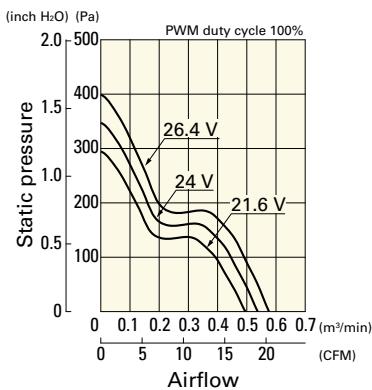

PWM duty - Speed characteristics example

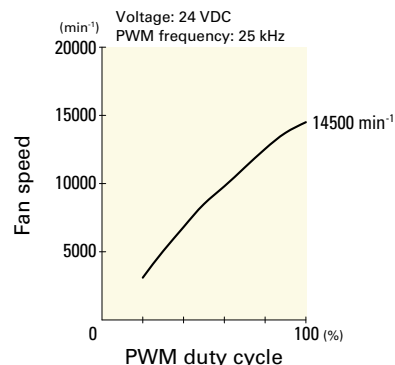

**9GA0424P3M001** With pulse sensor with PWM control function

PWM duty cycle

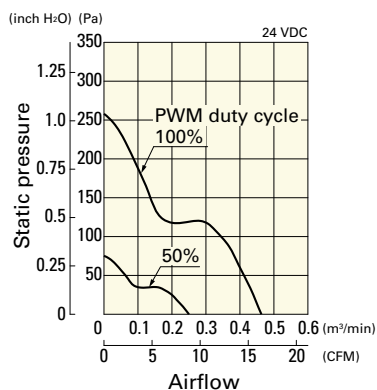

Operating voltage range

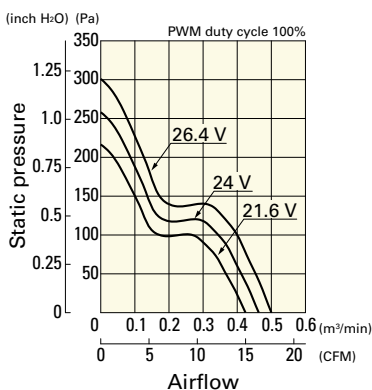

PWM duty - Speed characteristics example

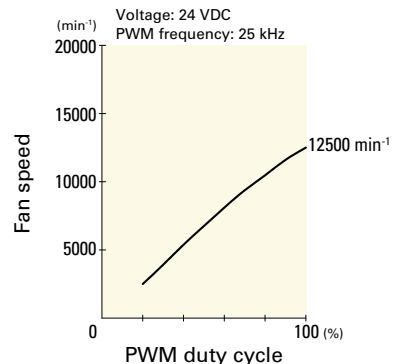

**Dimensions (unit: mm) (With ribs)**

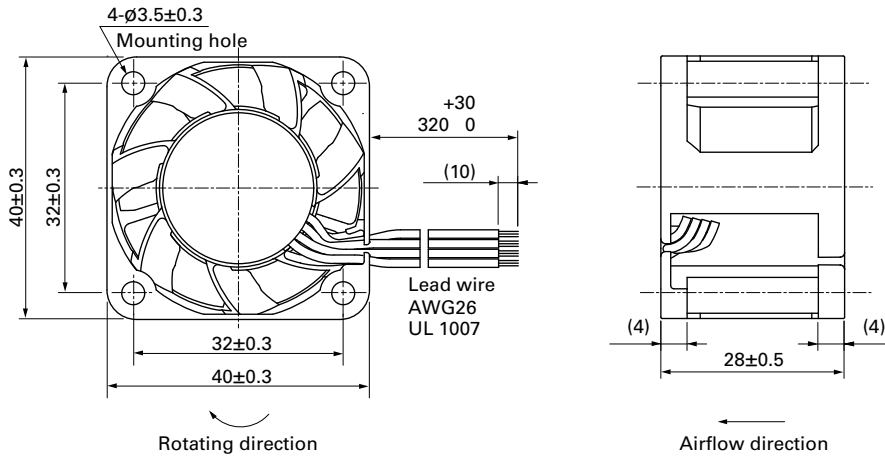

**Reference Dimensions of Mounting Holes and Vent Opening (unit: mm)**

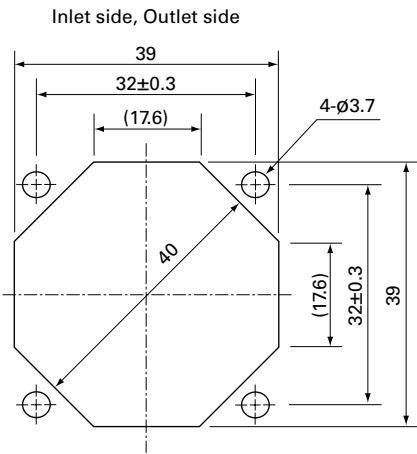

**Options**

Finger guards

page: p. 584

Model no.: 109-059, 109-059H