

# J Series® 3030 LEDs

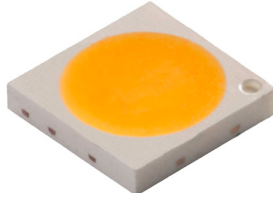

## PRODUCT DESCRIPTION

J Series® LEDs extend Cree LED's industry-leading portfolio of lighting-class LEDs to a broader set of applications. The J Series 3030 Standard LEDs combine high efficacy and excellent value in a reliable package. The J Series 3030 Standard LEDs are optimized for applications where high efficacy and smooth appearance are critical, such as troffers, panel and outdoor area lights.

## FEATURES

- Industry-compatible size : 3.0 x 3.0 x 0.5 mm
- 3-V and 6-V configurations
- Flux binned at 25 °C, chromaticity binned at 85 °C
- 6500 K–2200 K ANSI CCTs available
- 70, 80 & 90 CRI minimum available at 6500 K–2700 K
- 80 CRI minimum available at 2200 K
- RoHS and REACH compliant
- UL® recognized component (E495478)

## PRODUCT SUMMARY

Product	Power Class	Test Temperature	Test Current	Typical Forward Voltage	4000 K, 70 CRI		3000 K, 80 CRI		Maximum Current
					Typical Flux	Typical Efficacy	Typical Flux	Typical Efficacy	
JB3030 3-V Standard P Class	0.2 W	25 °C	65 mA	2.81 V	35.7 lm	196 LPW	31.7 lm	174 LPW	240 mA
JK3030 3-V Standard P Class	1 W	25 °C	350 mA	3.15 V	164 lm	149 LPW	144 lm	131 LPW	400 mA
JK3030 6-V Standard P Class	1 W	25 °C	150 mA	6.14 V	159 lm	173 LPW	141 lm	153 LPW	240 mA



J Series® Products are sold exclusively by Cree Venture LED Company Limited (“Cree Venture”), regardless of geography. Any orders for J Series Products that are submitted to Cree LED or any of its other subsidiaries will be directed to Cree Venture for acknowledgment and order fulfillment.

**Cree LED / 4400 Silicon Drive / Durham, NC 27703 USA / +1.919.313.5330 / [www.cree-led.com](http://www.cree-led.com)**

**TABLE OF CONTENTS**

Order Code & Bin Code Formats .....	3
Characteristics - JB3030 3-V Standard P Class.....	4
Operating Limits - JB3030 3-V Standard P Class .....	4
Flux Characteristics, Order Codes and Bins - JB3030 3-V Standard P Class.....	5
Relative Luminous Flux vs. Current - JB3030 3-V Standard P Class .....	6
Electrical Characteristics - JB3030 3-V Standard P Class .....	6
Relative Chromaticity vs. Current - JB3030 3-V Standard P Class .....	7
Relative Chromaticity vs. Temperature - JB3030 3-V Standard P Class .....	7
Characteristics - JK3030 3-V Standard P Class.....	8
Operating Limits - JK3030 3-V Standard P Class .....	8
Flux Characteristics, Order Codes and Bins - JK3030 3-V Standard P Class.....	9
Relative Luminous Flux vs. Current - JK3030 3-V Standard P Class .....	10
Electrical Characteristics - JK3030 3-V Standard P Class .....	10
Relative Chromaticity vs. Current - JK3030 3-V Standard P Class .....	11
Relative Chromaticity vs. Temperature - JK3030 3-V Standard P Class .....	11
Characteristics - JK3030 6-V Standard P Class.....	12
Operating Limits - JK3030 6-V Standard P Class .....	12
Flux Characteristics, Order Codes and Bins - JK3030 6-V Standard P Class.....	13
Relative Luminous Flux vs. Current - JK3030 6-V Standard P Class .....	14
Electrical Characteristics - JK3030 6-V Standard P Class .....	14
Relative Chromaticity vs. Current - JK3030 6-V Standard P Class .....	15
Relative Chromaticity vs. Temperature - JK3030 6-V Standard P Class .....	15
Relative Spectral Power Distribution .....	16
Relative Luminous Flux vs. Junction Temperature .....	17
Typical Spatial Distribution.....	17
Performance Groups - Luminous Flux.....	18
Performance Groups - Forward Voltage.....	19
Performance Groups - Chromaticity.....	20
Reflow Soldering Characteristics.....	29
Notes .....	30
Mechanical Dimensions .....	32
Tape & Reel.....	33
Packaging.....	34

## ORDER CODE & BIN CODE FORMATS

Order codes and bin codes for J Series 3030 Standard P Class LEDs are configured in the following manner:

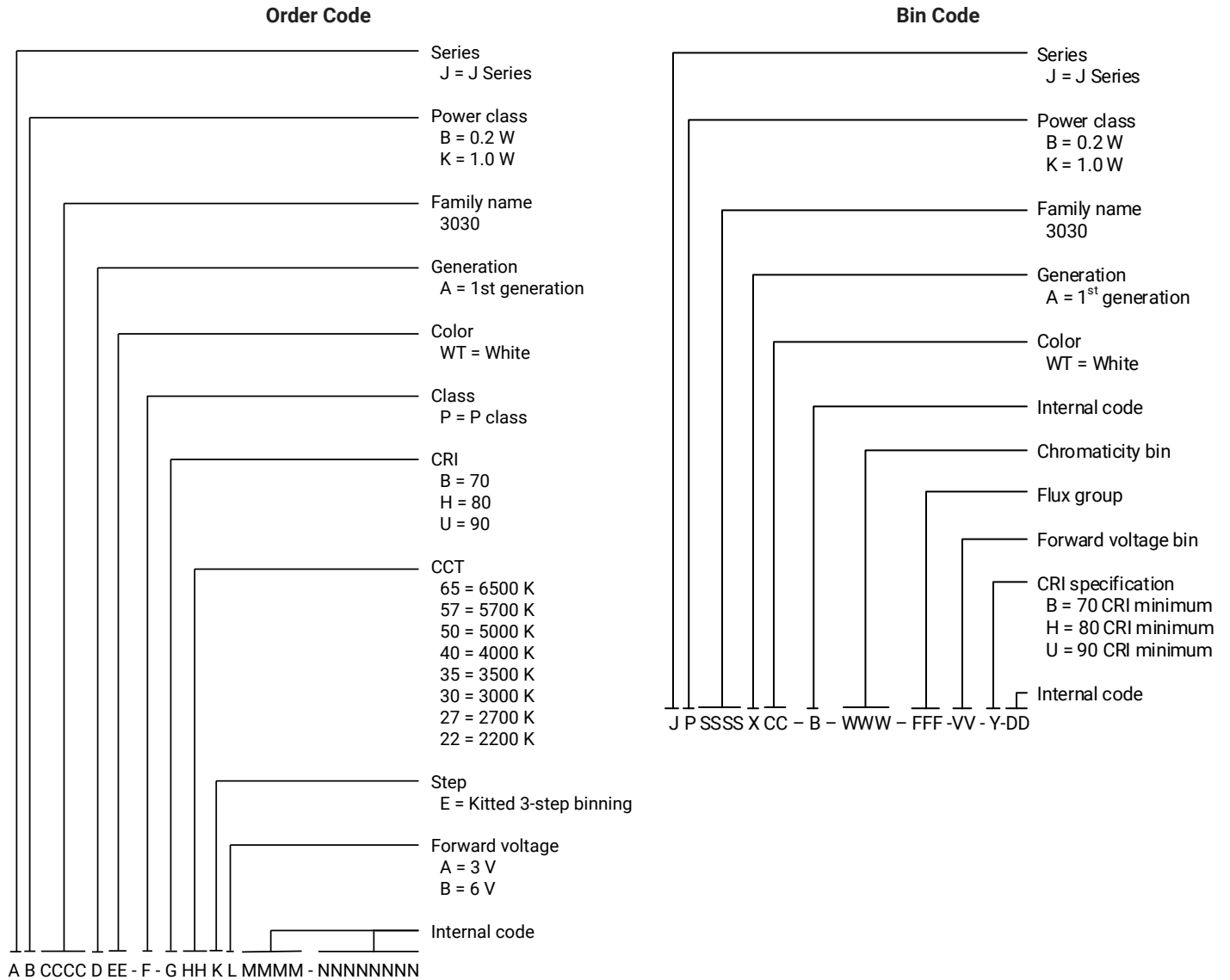

### CHARACTERISTICS - JB3030 3-V STANDARD P CLASS

Characteristics	Unit	Minimum	Typical	Maximum
Thermal resistance, junction to solder point	°C/W		14	
Viewing angle (FWHM)	degrees		120	
Temperature coefficient of voltage	mV/°C		-0.9	
ESD withstand voltage (JEDEC JS-001-2012)	V		Class 2	
DC forward current	mA			240
Reverse voltage	V			5
Forward voltage (@ 65 mA, 25 °C)	V		2.81	3.0
LED junction temperature	°C			125
Operating temperature	°C	-40		105

### OPERATING LIMITS - JB3030 3-V STANDARD P CLASS

The maximum forward current is determined by the thermal resistance between the LED junction and ambient.

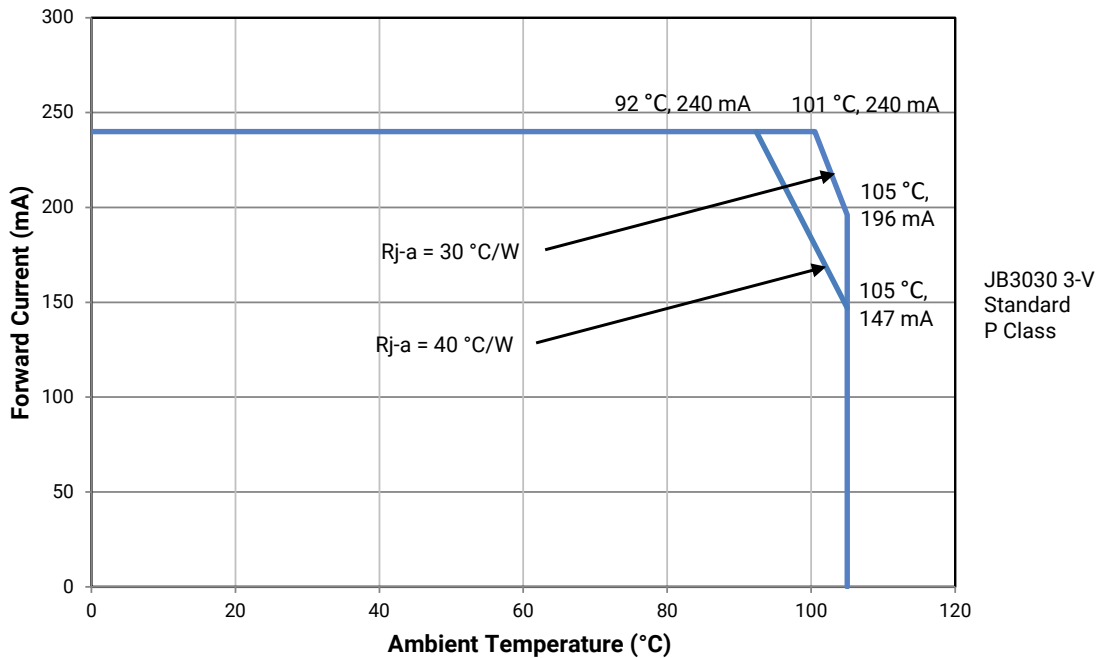

**FLUX CHARACTERISTICS, ORDER CODES AND BINS - JB3030 3-V STANDARD P CLASS ( $I_f = 65 \text{ mA}$ ,  $T_j = 25 \text{ °C}$ )**

The following table provides order codes for J Series JB3030 3-V Standard P Class LEDs. For a complete description of the order code nomenclature, please see the Order Code and Bin Code Formats section (page 3). For definitions of the chromaticity kits, please see the Performance Groups - Chromaticity section (page 20).

Nominal CCT	Minimum CRI	Minimum Flux (lm) @ 25 °C	Typical Flux (lm) @ 25 °C	Typical Flux (lm) @ 85 °C*	Kitted 3-Step Order Code**
6500 K	70	34	35.7	31.9	JB3030AWT-P-B65EA0000-N0000001
	80	32	33.8	30.2	JB3030AWT-P-H65EA0000-N0000001
	90	26	29	25.9	JB3030AWT-P-U65EA0000-N0000001
5700 K	70	34	35.7	31.9	JB3030AWT-P-B57EA0000-N0000001
	80	32	33.8	30.2	JB3030AWT-P-H57EA0000-N0000001
	90	26	29	25.9	JB3030AWT-P-U57EA0000-N0000001
5000 K	70	34	35.7	31.9	JB3030AWT-P-B50EA0000-N0000001
	80	32	33.8	30.2	JB3030AWT-P-H50EA0000-N0000001
	90	26	29	25.9	JB3030AWT-P-U50EA0000-N0000001
4000 K	70	34	35.7	31.9	JB3030AWT-P-B40EA0000-N0000001
	80	32	33.8	30.2	JB3030AWT-P-H40EA0000-N0000001
	90	26	29	25.9	JB3030AWT-P-U40EA0000-N0000001
3500 K	70	32	34.5	30.9	JB3030AWT-P-B35EA0000-N0000001
	80	30	32.8	29.3	JB3030AWT-P-H35EA0000-N0000001
	90	24	27.5	24.6	JB3030AWT-P-U35EA0000-N0000001
3000 K	70	30	33.5	30	JB3030AWT-P-B30EA0000-N0000001
	80	30	31.7	28.3	JB3030AWT-P-H30EA0000-N0000001
	90	24	27	24.1	JB3030AWT-P-U30EA0000-N0000001
2700 K	70	30	31.7	28.3	JB3030AWT-P-B27EA0000-N0000001
	80	28	30.5	27.3	JB3030AWT-P-H27EA0000-N0000001
	90	22	25.5	22.8	JB3030AWT-P-U27EA0000-N0000001

**Notes:**

- Cree Venture maintains a tolerance of  $\pm 7\%$  on flux and power measurements,  $\pm 0.005$  on chromaticity (CCx, CCy) measurements and  $\pm 2$  on CRI measurements. See the Measurements section (page 30).
- Cree Venture J Series 3030 LED order codes specify only a minimum flux bin and not a maximum. Cree Venture may ship reels in flux bins higher than the minimum specified by the order code without advance notice. Shipments will always adhere to the chromaticity restrictions specified by the order code.
- \* Flux values @ 85 °C are calculated and for reference only.
- \*\* Contact your Cree sales representative for kitted 3-step order code details.

RELATIVE LUMINOUS FLUX VS. CURRENT - JB3030 3-V STANDARD P CLASS

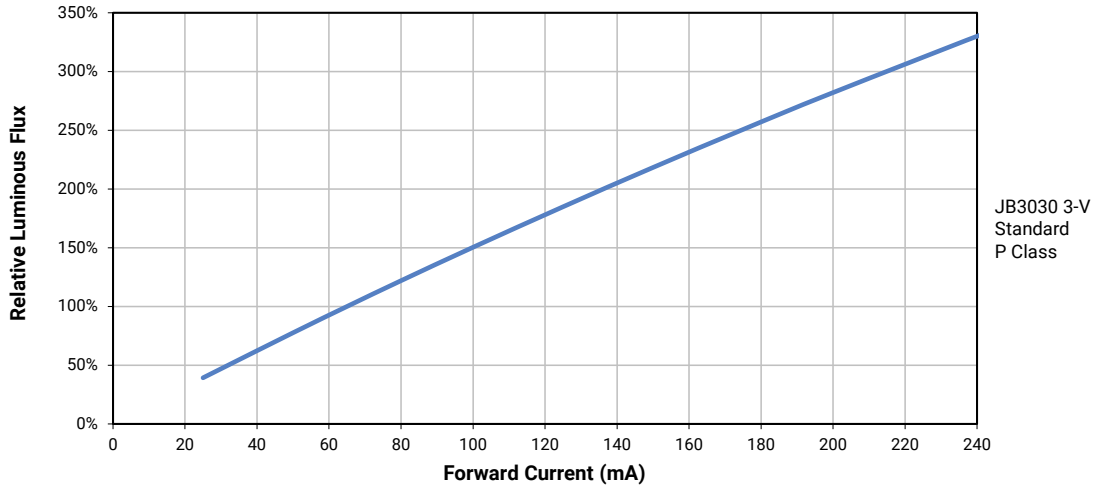

ELECTRICAL CHARACTERISTICS - JB3030 3-V STANDARD P CLASS

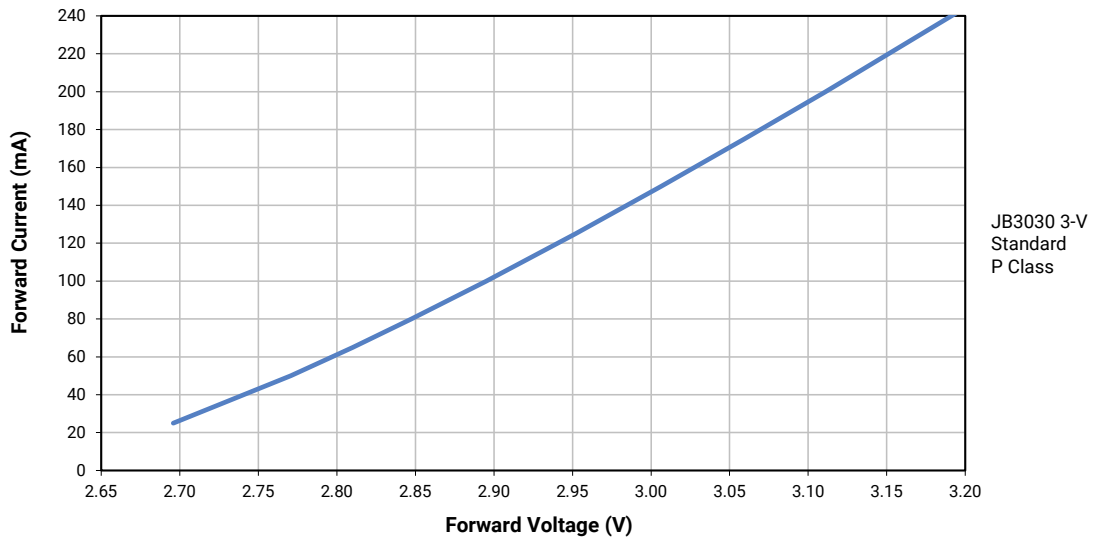

RELATIVE CHROMATICITY VS. CURRENT - JB3030 3-V STANDARD P CLASS

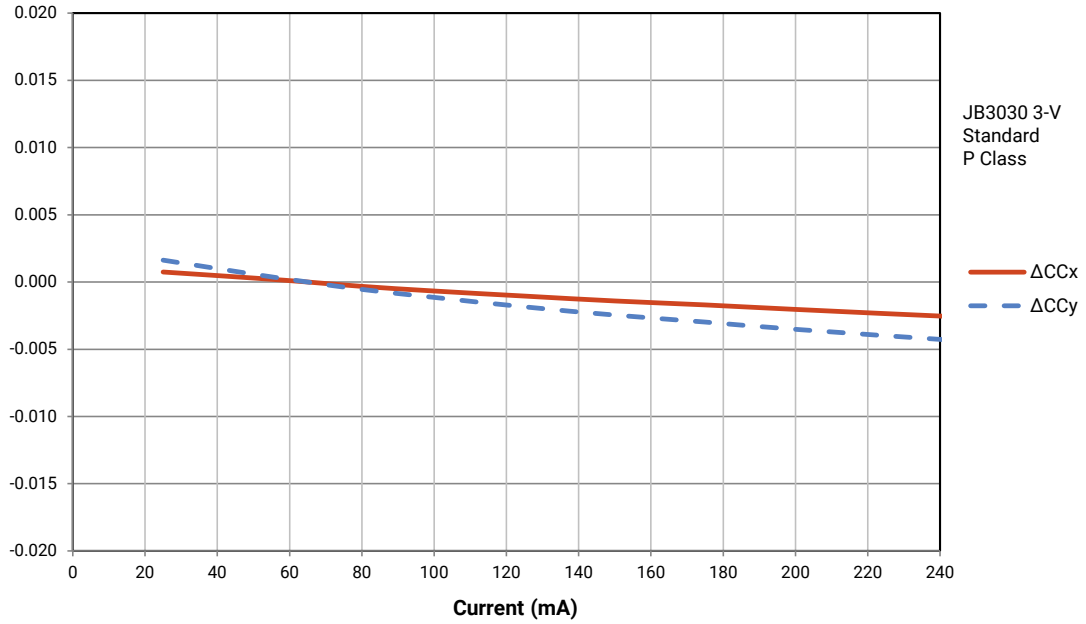

RELATIVE CHROMATICITY VS. TEMPERATURE - JB3030 3-V STANDARD P CLASS

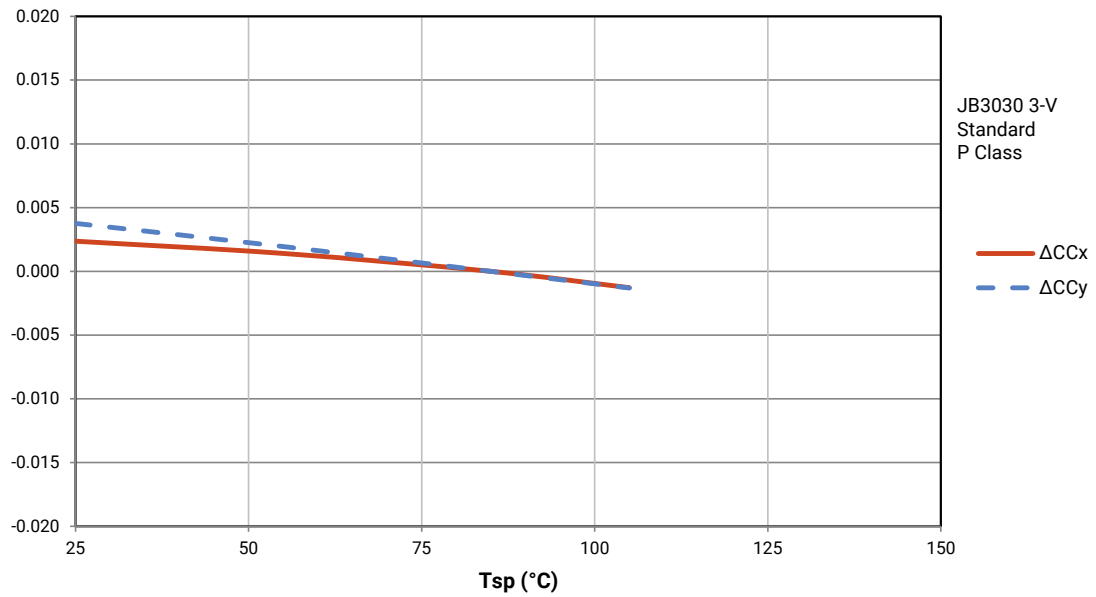

### CHARACTERISTICS - JK3030 3-V STANDARD P CLASS

Characteristics	Unit	Minimum	Typical	Maximum
Thermal resistance, junction to solder point	°C/W		18	
Viewing angle (FWHM)	degrees		120	
Temperature coefficient of voltage	mV/°C		-1.1	
ESD withstand voltage (JEDEC JS-001-2012)	V		Class 2	
DC forward current	mA			400
Reverse voltage	V			5
Forward voltage (@ 350 mA, 25 °C)	V		3.15	3.3
LED junction temperature	°C			125
Operating temperature	°C	-40		105

### OPERATING LIMITS - JK3030 3-V STANDARD P CLASS

The maximum forward current is determined by the thermal resistance between the LED junction and ambient.

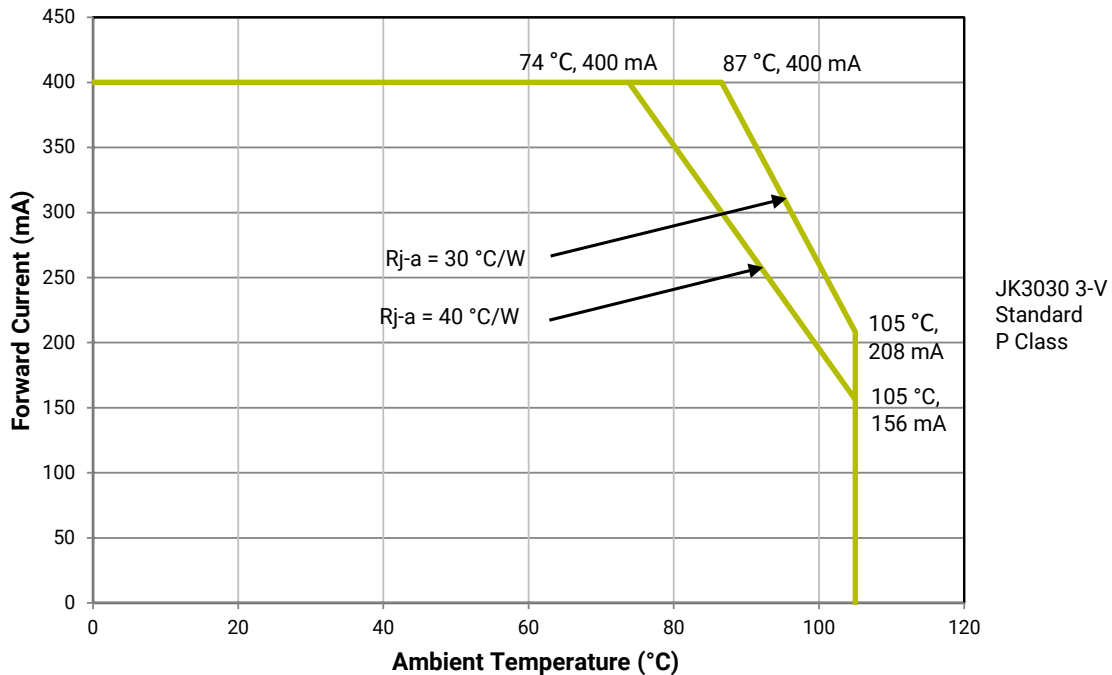



**FLUX CHARACTERISTICS, ORDER CODES AND BINS - JK3030 3-V STANDARD P CLASS ( $I_f = 350 \text{ mA}$ ,  $T_j = 25 \text{ °C}$ )**

The following table provides order codes for J Series JK3030 3-V Standard P Class LEDs. For a complete description of the order code nomenclature, please see the Order Code and Bin Code Formats section (page 3). For definitions of the chromaticity kits, please see the Performance Groups - Chromaticity section (page 20).

Nominal CCT	Minimum CRI	Minimum Flux (lm) @ 25 °C	Typical Flux (lm) @ 25 °C	Typical Flux (lm) @ 85 °C*	Kitted 3-Step Order Code**
6500 K	70	149	164	142	JK3030AWT-P-B65EA0000-N0000001
	80	142	154	133	JK3030AWT-P-H65EA0000-N0000001
	90	114	126	109	JK3030AWT-P-U65EA0000-N0000001
5700 K	70	149	164	142	JK3030AWT-P-B57EA0000-N0000001
	80	142	154	133	JK3030AWT-P-H57EA0000-N0000001
	90	114	126	109	JK3030AWT-P-U57EA0000-N0000001
5000 K	70	149	164	142	JK3030AWT-P-B50EA0000-N0000001
	80	142	154	133	JK3030AWT-P-H50EA0000-N0000001
	90	114	126	109	JK3030AWT-P-U50EA0000-N0000001
4000 K	70	149	164	142	JK3030AWT-P-B40EA0000-N0000001
	80	142	154	133	JK3030AWT-P-H40EA0000-N0000001
	90	114	126	109	JK3030AWT-P-U40EA0000-N0000001
3500 K	70	149	160	138	JK3030AWT-P-B35EA0000-N0000001
	80	135	150	130	JK3030AWT-P-H35EA0000-N0000001
	90	114	123	106	JK3030AWT-P-U35EA0000-N0000001
3000 K	70	142	155	134	JK3030AWT-P-B30EA0000-N0000001
	80	135	144	125	JK3030AWT-P-H30EA0000-N0000001
	90	107	119	103	JK3030AWT-P-U30EA0000-N0000001
2700 K	70	142	149	129	JK3030AWT-P-B27EA0000-N0000001
	80	128	140	121	JK3030AWT-P-H27EA0000-N0000001
	90	107	114	99	JK3030AWT-P-U27EA0000-N0000001

**Notes:**

- Cree Venture maintains a tolerance of  $\pm 7\%$  on flux and power measurements,  $\pm 0.005$  on chromaticity (CCx, CCy) measurements and  $\pm 2$  on CRI measurements. See the Measurements section (page 30).
- Cree Venture J Series 3030 LED order codes specify only a minimum flux bin and not a maximum. Cree Venture may ship reels in flux bins higher than the minimum specified by the order code without advance notice. Shipments will always adhere to the chromaticity restrictions specified by the order code.
- \* Flux values @ 85 °C are calculated and for reference only.
- \*\* Contact your Cree sales representative for kitted 3-step order code details.

RELATIVE LUMINOUS FLUX VS. CURRENT - JK3030 3-V STANDARD P CLASS

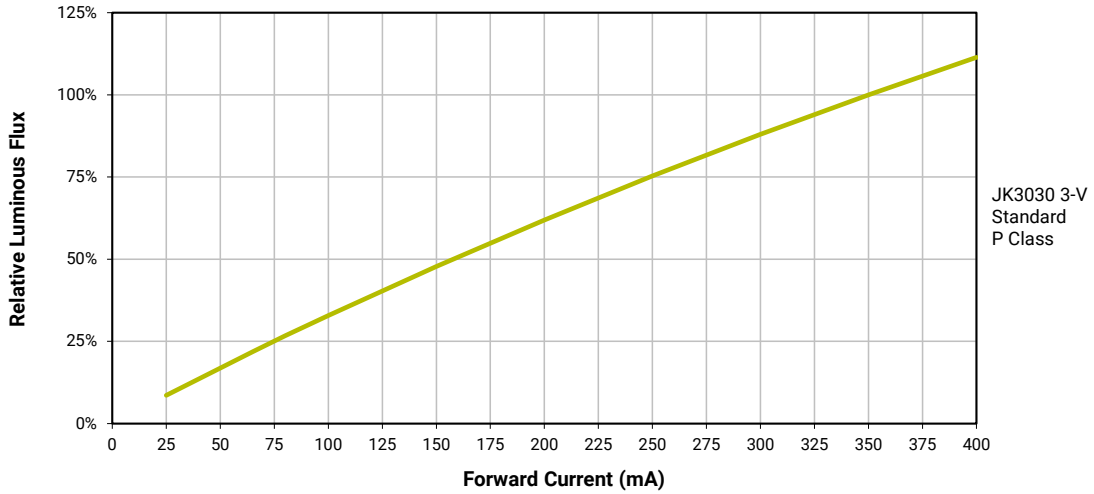

ELECTRICAL CHARACTERISTICS - JK3030 3-V STANDARD P CLASS

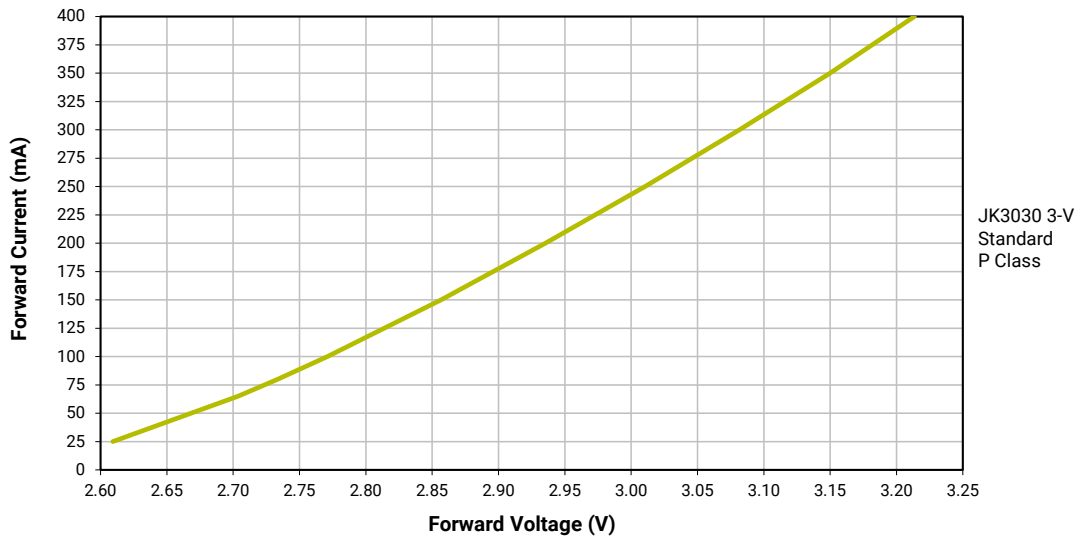

RELATIVE CHROMATICITY VS. CURRENT - JK3030 3-V STANDARD P CLASS

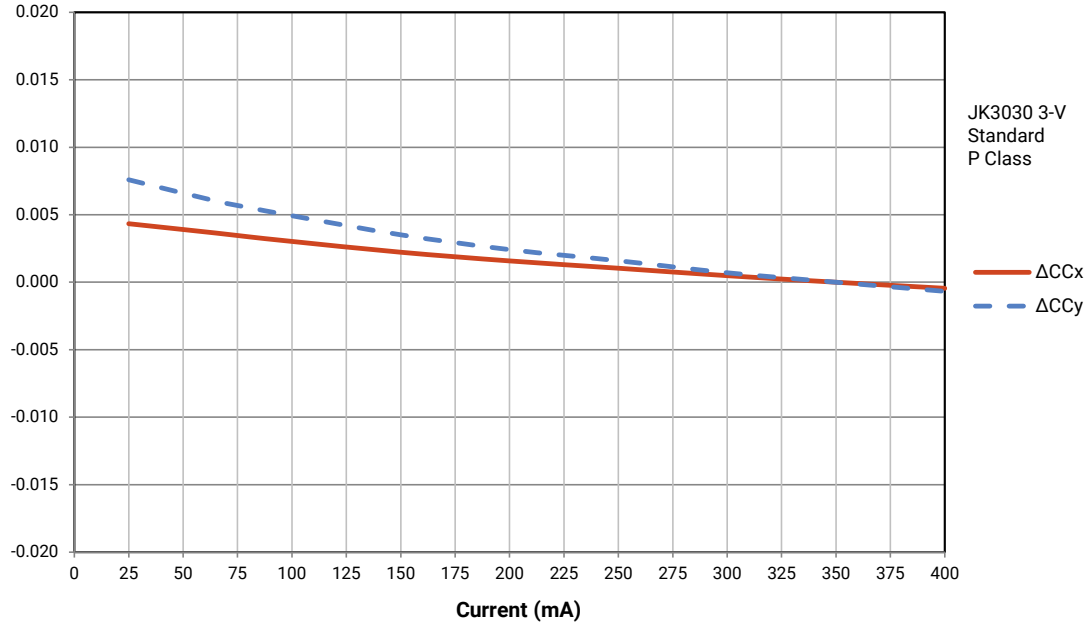

RELATIVE CHROMATICITY VS. TEMPERATURE - JK3030 3-V STANDARD P CLASS

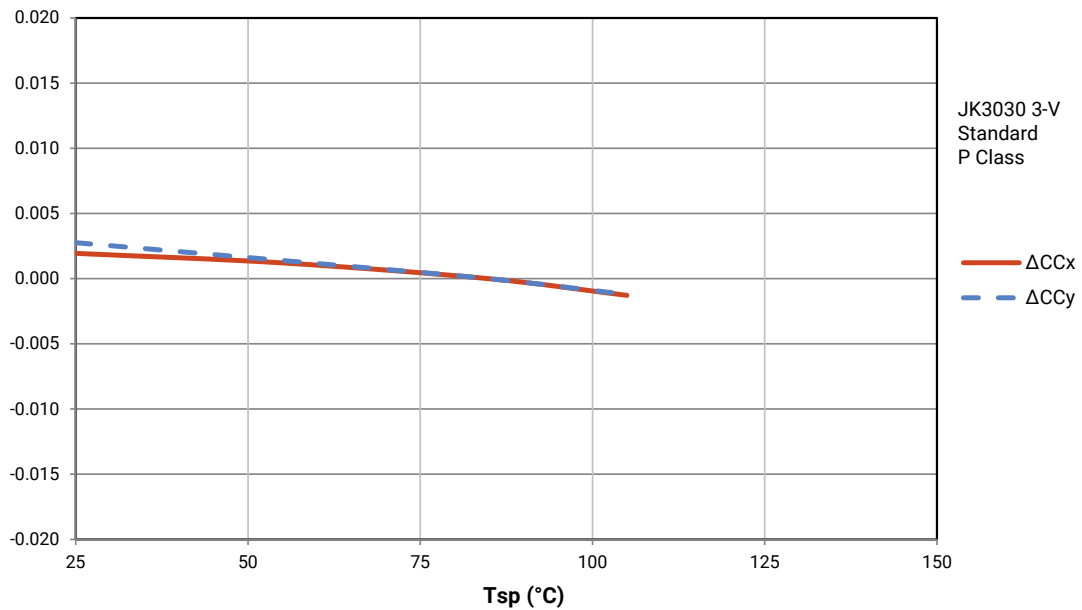

### CHARACTERISTICS - JK3030 6-V STANDARD P CLASS

Characteristics	Unit	Minimum	Typical	Maximum
Thermal resistance, junction to solder point	°C/W		11	
Viewing angle (FWHM)	degrees		120	
Temperature coefficient of voltage	mV/°C		-1.8	
ESD withstand voltage (JEDEC JS-001-2012)	V		Class 2	
DC forward current	mA			240
Reverse voltage	V			5
Forward voltage (@ 150 mA, 25 °C)	V		6.14	6.4
LED junction temperature	°C			125
Operating temperature	°C	-40		105

### OPERATING LIMITS - JK3030 6-V STANDARD P CLASS

The maximum forward current is determined by the thermal resistance between the LED junction and ambient.

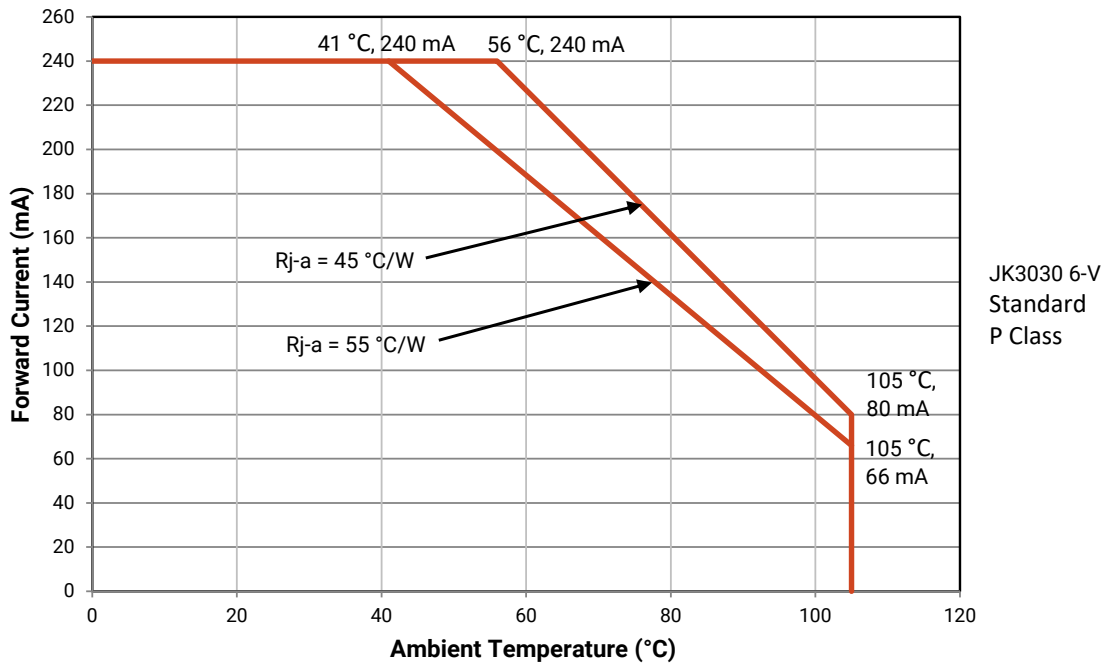

## FLUX CHARACTERISTICS, ORDER CODES AND BINS - JK3030 6-V STANDARD P CLASS ( $I_f = 150 \text{ mA}$ , $T_j = 25 \text{ °C}$ )

The following table provides order codes for J Series JK3030 6-V Standard P Class LEDs. For a complete description of the order code nomenclature, please see the Order Code and Bin Code Formats section (page 3). For definitions of the chromaticity kits, please see the Performance Groups - Chromaticity section (page 20).

Nominal CCT	Minimum CRI	Minimum Flux (lm) @ 25 °C	Typical Flux (lm) @ 25 °C	Typical Flux (lm) @ 85 °C*	Kitted 3-Step Order Code**
6500 K	70	149	158	142	JK3030AWT-P-B65EB0000-N0000001
	80	135	147	132	JK3030AWT-P-H65EB0000-N0000001
	90	114	126	114	JK3030AWT-P-U65EB0000-N0000001
5700 K	70	149	159	143	JK3030AWT-P-B57EB0000-N0000001
	80	142	148.5	134	JK3030AWT-P-H57EB0000-N0000001
	90	121	127	114	JK3030AWT-P-U57EB0000-N0000001
5000 K	70	149	159	143	JK3030AWT-P-B50EB0000-N0000001
	80	142	148.5	134	JK3030AWT-P-H50EB0000-N0000001
	90	121	127	114	JK3030AWT-P-U50EB0000-N0000001
4000 K	70	149	159	143	JK3030AWT-P-B40EB0000-N0000001
	80	142	148.5	134	JK3030AWT-P-H40EB0000-N0000001
	90	121	127	114	JK3030AWT-P-U40EB0000-N0000001
3500 K	70	142	154	139	JK3030AWT-P-B35EB0000-N0000001
	80	135	144	130	JK3030AWT-P-H35EB0000-N0000001
	90	114	122	110	JK3030AWT-P-U35EB0000-N0000001
3000 K	70	142	150	135	JK3030AWT-P-B30EB0000-N0000001
	80	128	141	127	JK3030AWT-P-H30EB0000-N0000001
	90	107	119	107	JK3030AWT-P-U30EB0000-N0000001
2700 K	70	135	143	129	JK3030AWT-P-B27EB0000-N0000001
	80	128	135	122	JK3030AWT-P-H27EB0000-N0000001
	90	107	114.2	103	JK3030AWT-P-U27EB0000-N0000001
2200 K	80	107	115.7	104	JK3030AWT-P-H22EB0000-N0000001

### Notes:

- Cree Venture maintains a tolerance of  $\pm 7\%$  on flux and power measurements,  $\pm 0.005$  on chromaticity (CCx, CCy) measurements and  $\pm 2$  on CRI measurements. See the Measurements section (page 30).
- Cree Venture J Series 3030 LED order codes specify only a minimum flux bin and not a maximum. Cree Venture may ship reels in flux bins higher than the minimum specified by the order code without advance notice. Shipments will always adhere to the chromaticity restrictions specified by the order code.
- \* Flux values @ 85 °C are calculated and for reference only.
- \*\* Contact your Cree sales representative for kitted 3-step order code details.

RELATIVE LUMINOUS FLUX VS. CURRENT - JK3030 6-V STANDARD P CLASS

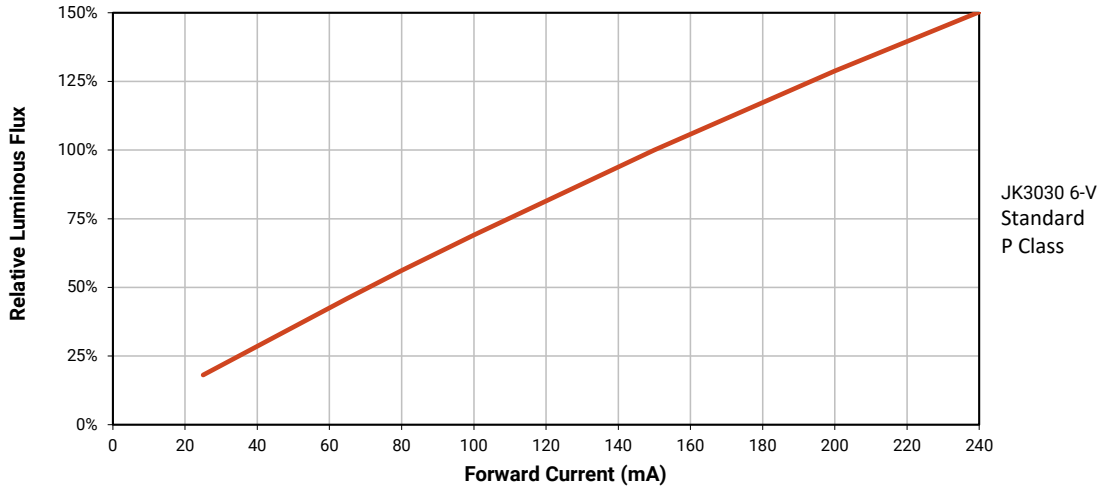

ELECTRICAL CHARACTERISTICS - JK3030 6-V STANDARD P CLASS

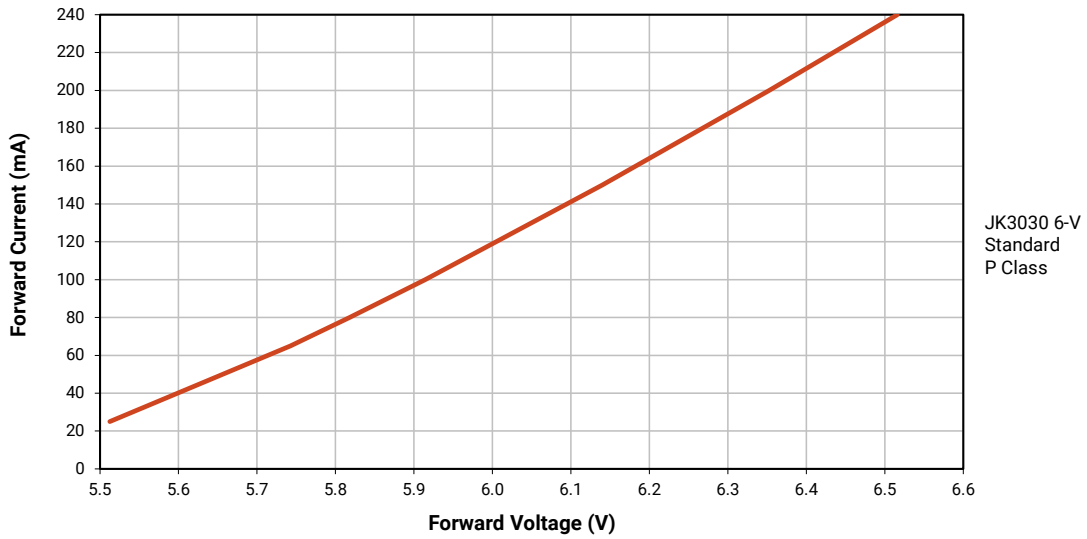

RELATIVE CHROMATICITY VS. CURRENT - JK3030 6-V STANDARD P CLASS

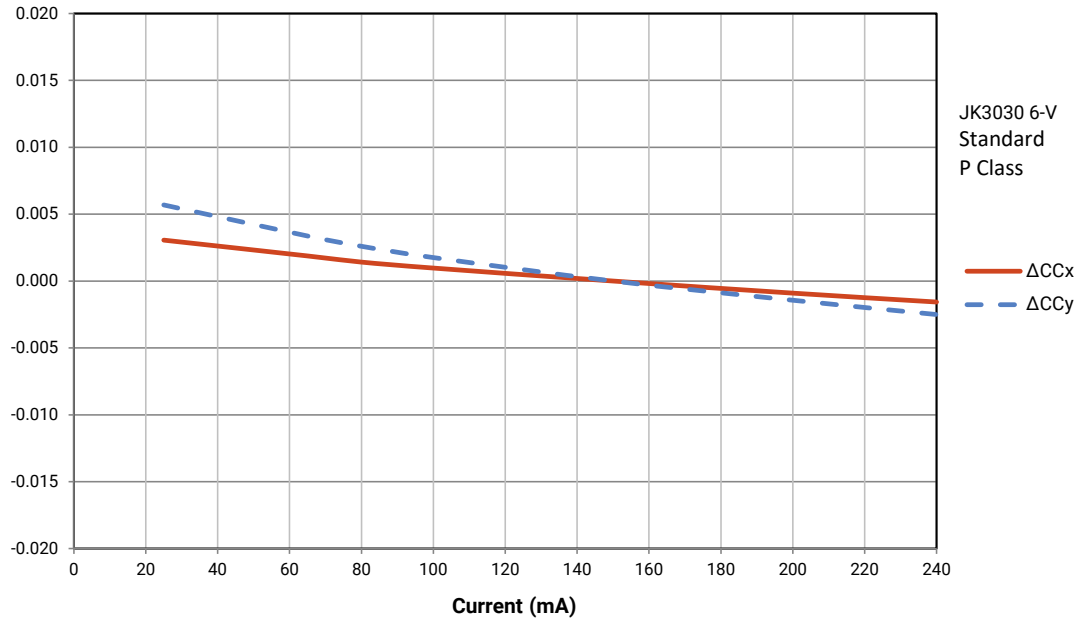

RELATIVE CHROMATICITY VS. TEMPERATURE - JK3030 6-V STANDARD P CLASS

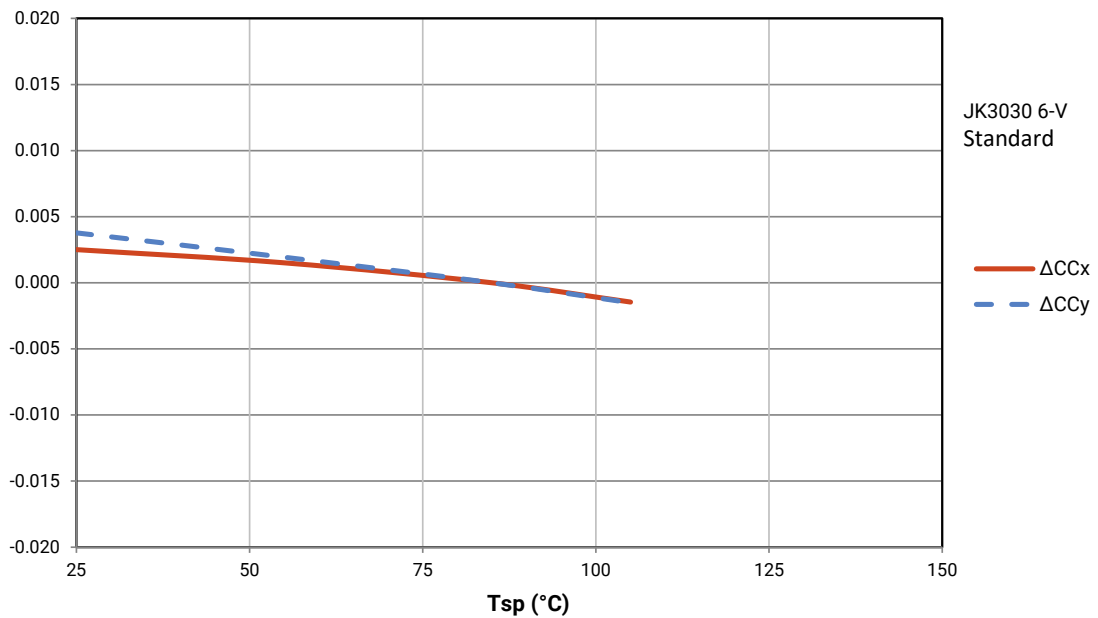

RELATIVE SPECTRAL POWER DISTRIBUTION

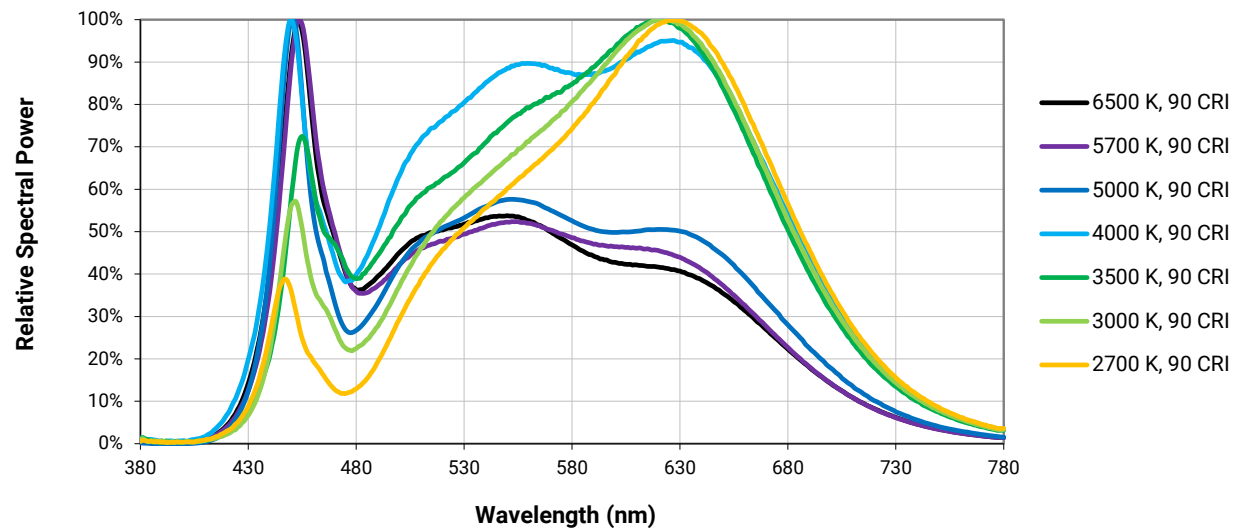
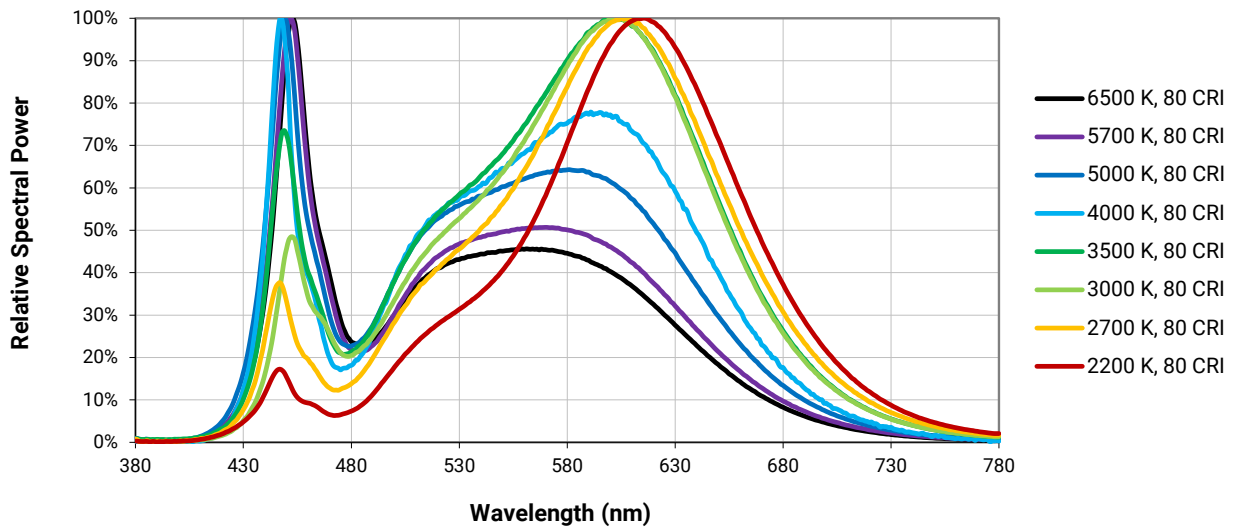
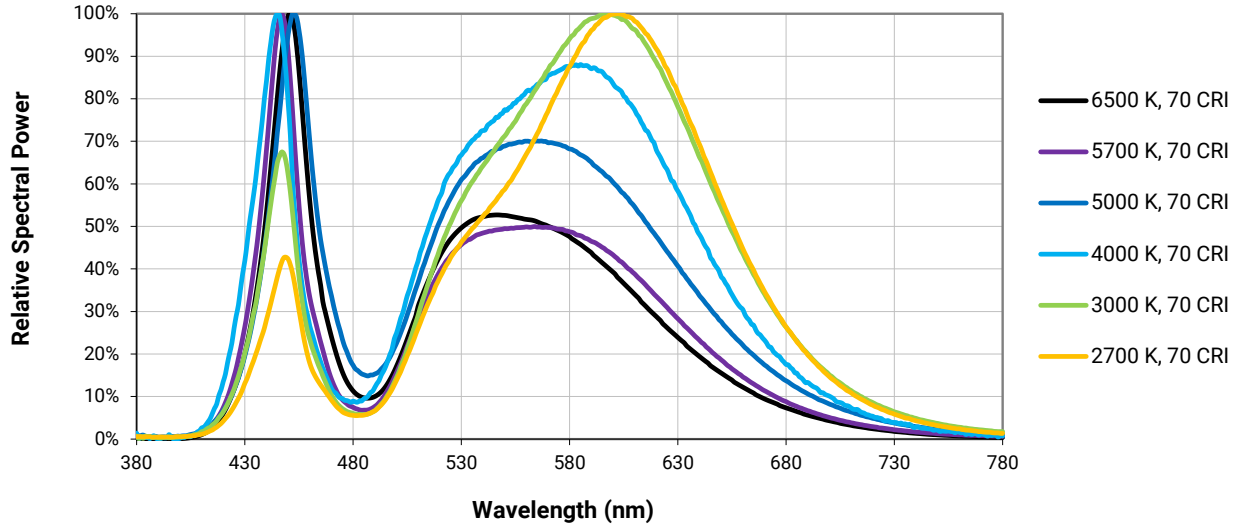



## RELATIVE LUMINOUS FLUX VS. JUNCTION TEMPERATURE

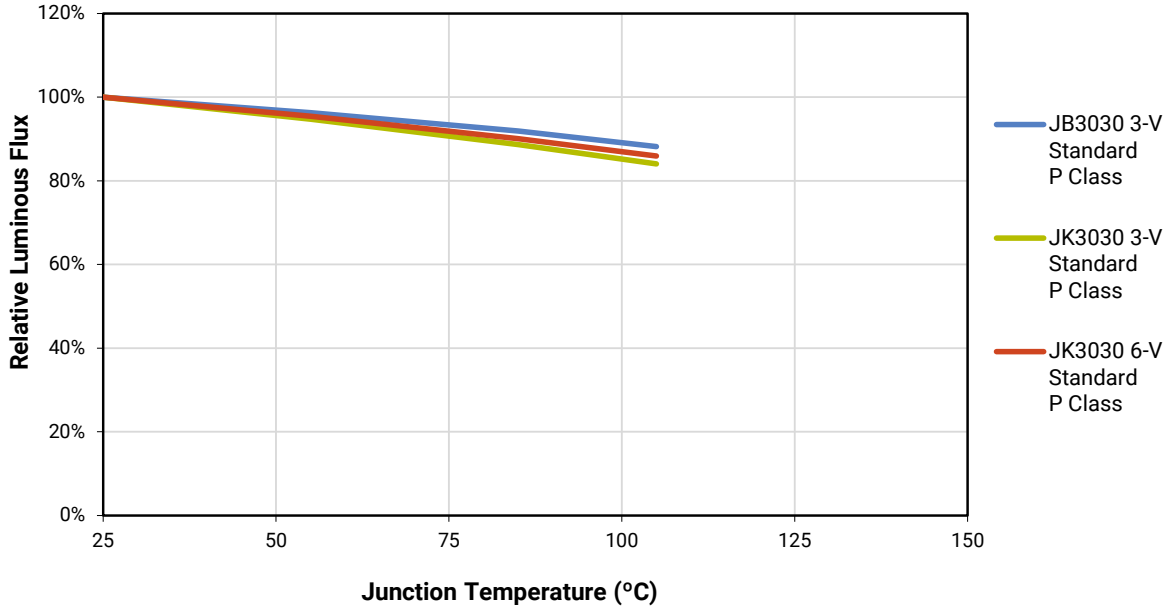

## TYPICAL SPATIAL DISTRIBUTION

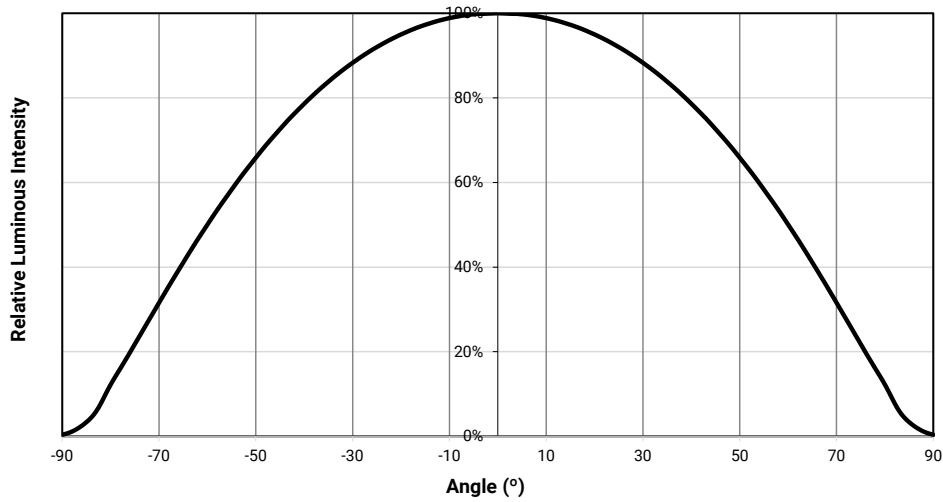

## PERFORMANCE GROUPS - LUMINOUS FLUX ( $T_j = 25\text{ }^\circ\text{C}$ )

J Series JB3030 3-V Standard P Class LEDs are tested for luminous flux at 65 mA and placed into one of the following luminous-flux groups.

Group Code	Minimum Luminous Flux (lm)	Maximum Luminous Flux (lm)
C3	22	24
C4	24	26
C5	26	28
D2	28	30
D3	30	32
D4	32	34
D5	34	36
E2	36	38
E3	38	40

J Series JK3030 3-V Standard P Class LEDs are tested for luminous flux at 350 mA. J Series JK3030 6-V Standard P Class LEDs are tested for luminous flux at 150 mA. Both are placed into one of the following luminous-flux groups.

Group Code	Minimum Luminous Flux (lm)	Maximum Luminous Flux (lm)
H4	100	107
J2	107	114
J4	114	121
K2	121	128
K4	128	135
L2	135	142
L4	142	149
M2	149	156
M4	156	163
N2	163	170
N4	170	177

**PERFORMANCE GROUPS - FORWARD VOLTAGE ( $T_j = 25\text{ }^\circ\text{C}$ )**

J Series 3030 Standard P Class LEDs are tested for forward voltage and placed into one of the following voltage bins.

The following voltage bins are indicated in the Forward Voltage Bin field in the bin code for JB3030 3-V Standard P Class LEDs.

Voltage Bin	Minimum Forward Voltage (V)	Maximum Forward Voltage (V)
AD	2.7	2.8
AE	2.8	2.9
AF	2.9	3.0

The following voltage bins are indicated in the Forward Voltage Bin field in the bin code for JK3030 3-V Standard P Class LEDs.

Voltage Bin	Minimum Forward Voltage (V)	Maximum Forward Voltage (V)
AG	3.0	3.1
AH	3.1	3.2
AJ	3.2	3.3

The following voltage bins are indicated in the Forward Voltage Bin field in the bin code for JK3030 6-V Standard P Class LEDs.

Voltage Bin	Minimum Forward Voltage (V)	Maximum Forward Voltage (V)
BP	5.8	6.0
BQ	6.0	6.2
BR	6.2	6.4

## PERFORMANCE GROUPS - CHROMATICITY ( $T_j = 85\text{ }^\circ\text{C}$ )

J Series 3030 Standard P Class LEDs are tested for chromaticity and placed into one of the regions defined by the following bounding coordinates.

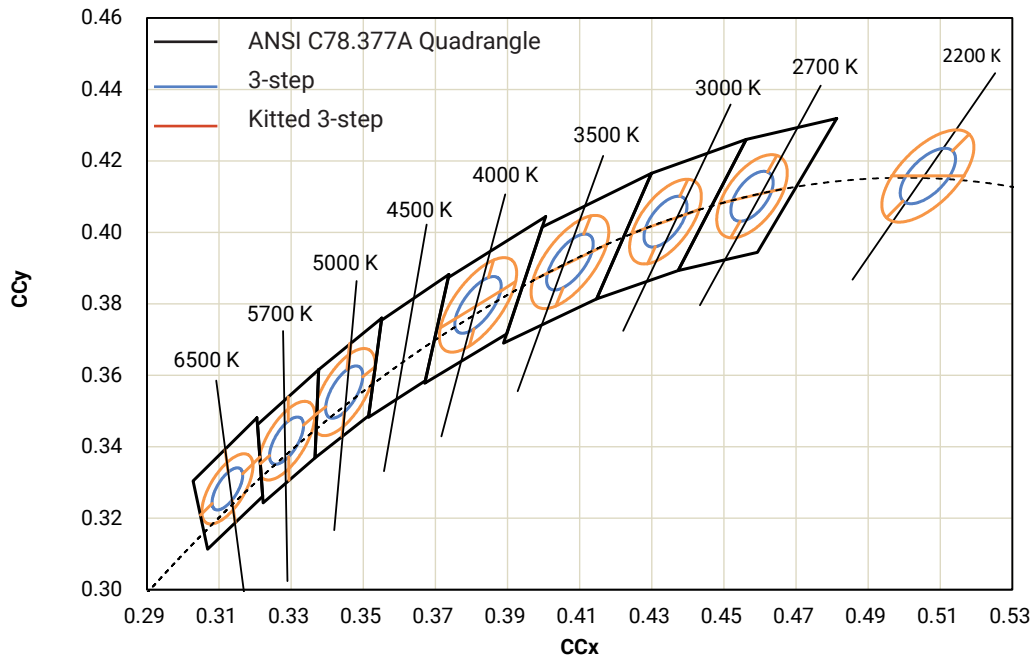

PERFORMANCE GROUPS - CHROMATICITY - CONTINUED ( $T_j = 85\text{ }^\circ\text{C}$ )

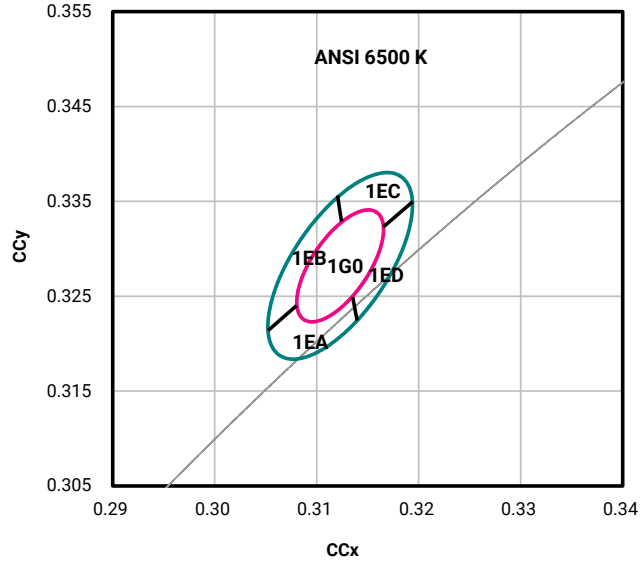

CCT	MacAdam Ellipse	Included Bins	Center Point		Major Axis	Minor Axis	Rotation Angle (°)
			x	y	a	b	
6500 K	3-step	1G0	0.3123	0.3282	0.00669	0.00285	58.57
	Kitted 3-step	1G0, 1EA, 1EB, 1EC, 1ED	0.3123	0.3282	0.01115	0.00475	58.57

PERFORMANCE GROUPS - CHROMATICITY - CONTINUED ( $T_j = 85\text{ }^\circ\text{C}$ )

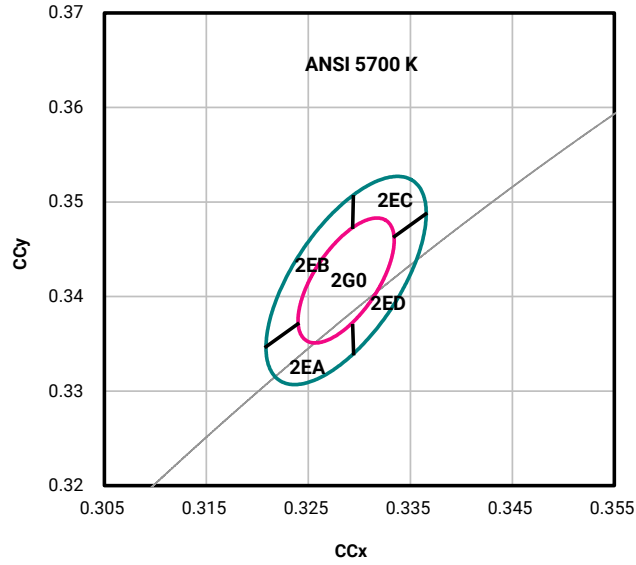

CCT	MacAdam Ellipse	Included Bins	Center Point		Major Axis	Minor Axis	Rotation Angle (°)
			x	y	a	b	
5700 K	3-step	2G0	0.3287	0.3417	0.00746	0.00320	59.09
	Kitted 3-step	2G0, 2EA, 2EB, 2EC, 2ED	0.3287	0.3417	0.01243	0.00533	59.09

PERFORMANCE GROUPS - CHROMATICITY - CONTINUED ( $T_j = 85\text{ }^\circ\text{C}$ )

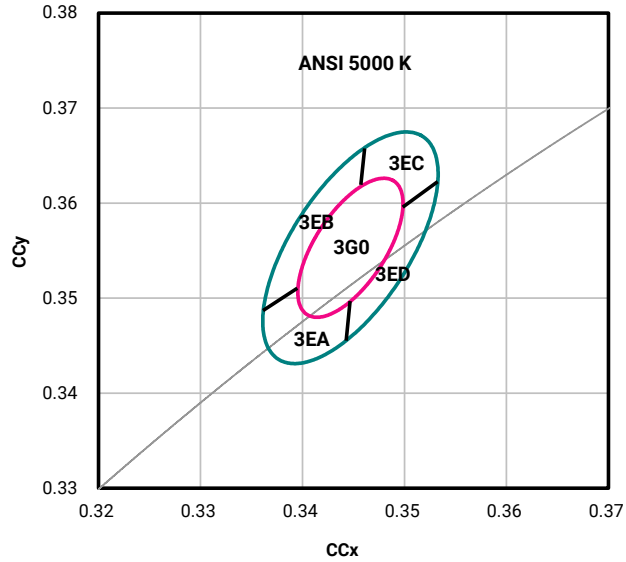

CCT	MacAdam Ellipse	Included Bins	Center Point		Major Axis	Minor Axis	Rotation Angle (°)
			x	y	a	b	
5000 K	3-step	3G0	0.3447	0.3553	0.00822	0.00354	59.62
	Kitted 3-step	3G0, 3EA, 3EB, 3EC, 3ED	0.3447	0.3553	0.01370	0.00590	59.62

PERFORMANCE GROUPS - CHROMATICITY - CONTINUED ( $T_j = 85\text{ }^\circ\text{C}$ )

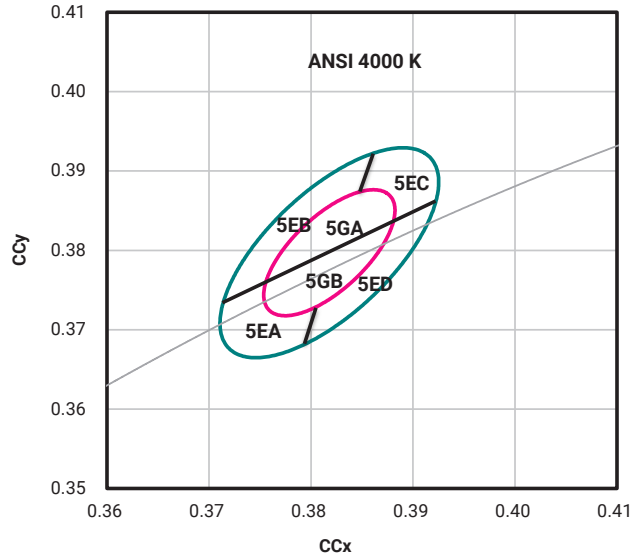

CCT	MacAdam Ellipse	Included Bins	Center Point		Major Axis	Minor Axis	Rotation Angle (°)
			x	y	a	b	
4000 K	3-step	5GA, 5GB	0.3818	0.3797	0.00939	0.00402	53.72
	Kitted 3-step	5GA, 5GB, 5EA, 5EB, 5EC, 5ED	0.3818	0.3797	0.01565	0.00670	53.72



PERFORMANCE GROUPS - CHROMATICITY - CONTINUED ( $T_j = 85\text{ }^\circ\text{C}$ )

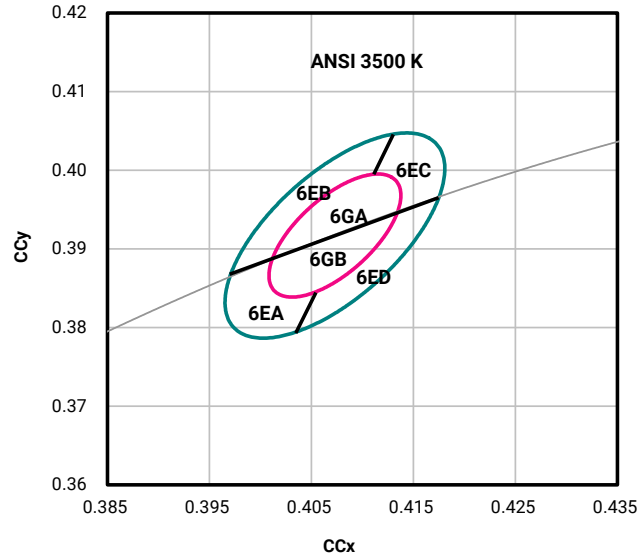

CCT	MacAdam Ellipse	Included Bins	Center Point		Major Axis	Minor Axis	Rotation Angle (°)
			x	y	a	b	
3500 K	3-step	6GA, 6GB	0.4073	0.3917	0.00927	0.00414	53.22
	Kitted 3-step	6GA, 6GB, 6EA, 6EB, 6EC, 6ED	0.4073	0.3917	0.01545	0.00690	53.22

PERFORMANCE GROUPS - CHROMATICITY - CONTINUED ( $T_j = 85\text{ }^\circ\text{C}$ )

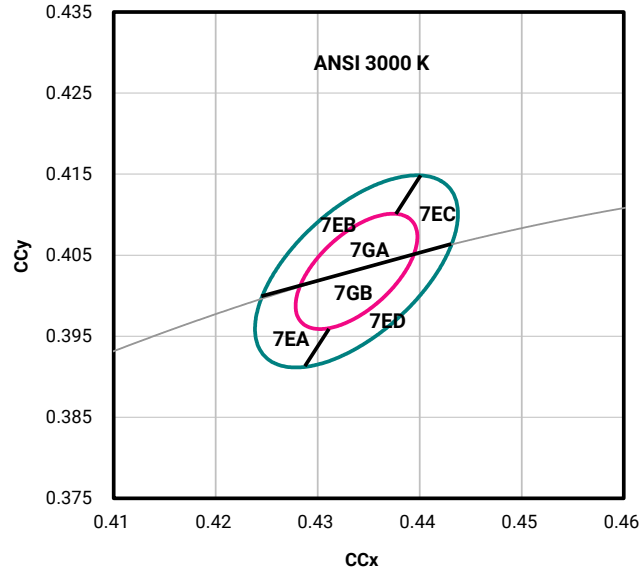

CCT	MacAdam Ellipse	Included Bins	Center Point		Major Axis	Minor Axis	Rotation Angle (°)
			x	y	a	b	
3000 K	3-step	7GA, 7GB	0.4338	0.4030	0.00834	0.00408	53.22
	Kitted 3-step	7GA, 7GB, 7EA, 7EB 7EC, 7ED	0.4338	0.4030	0.01390	0.00680	53.22

PERFORMANCE GROUPS - CHROMATICITY - CONTINUED ( $T_j = 85\text{ }^\circ\text{C}$ )

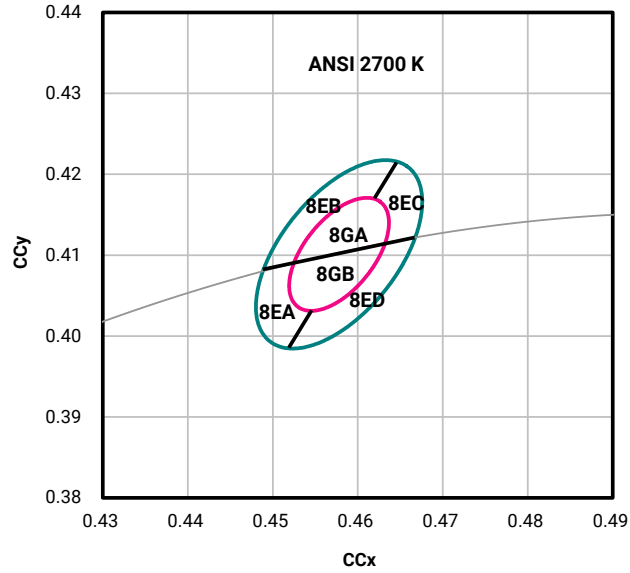

CCT	MacAdam Ellipse	Included Bins	Center Point		Major Axis	Minor Axis	Rotation Angle (°)
			x	y	a	b	
2700 K	3-step	8GA, 8GB	0.4578	0.4101	0.00810	0.00420	53.70
	Kitted 3-step	8GA, 8GB, 8EA, 8EB, 8EC, 8ED	0.4578	0.4101	0.01350	0.00700	53.70

PERFORMANCE GROUPS - CHROMATICITY - CONTINUED ( $T_j = 85\text{ }^\circ\text{C}$ )

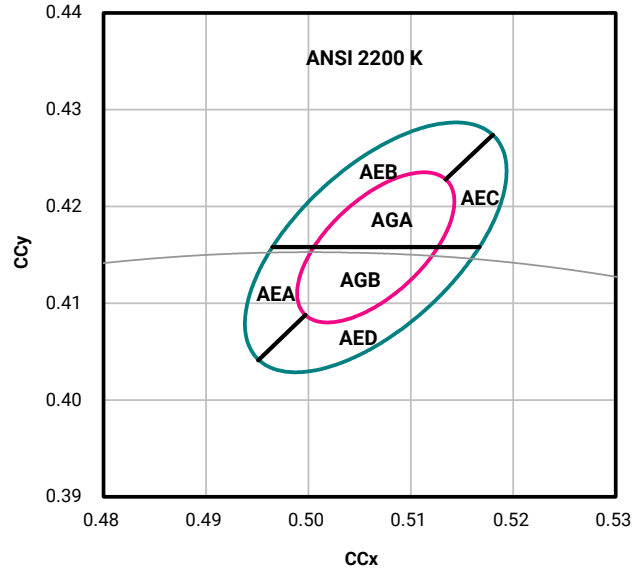

CCT	MacAdam Ellipse	Included Bins	Center Point		Major Axis	Minor Axis	Rotation Angle (°)
			x	y	a	b	
2200 K	3-step	AGA, AGB	0.5066	0.4158	0.0098	0.0048	45.5
	Kitted 3-step	AGA, AGB, AEA, AEB, AEC, AED	0.5066	0.4158	0.0163	0.0080	45.5

## REFLOW SOLDERING CHARACTERISTICS

In testing, Cree Venture has found J Series 3030 Standard P Class LEDs to be compatible with JEDEC J-STD-020C, using the parameters listed below. As a general guideline, Cree Venture recommends that users follow the recommended soldering profile provided by the manufacturer of the solder paste used, and therefore it is the lamp or luminaire manufacturer’s responsibility to determine applicable soldering requirements.

Note that this general guideline may not apply to all PCB designs and configurations of reflow soldering equipment.

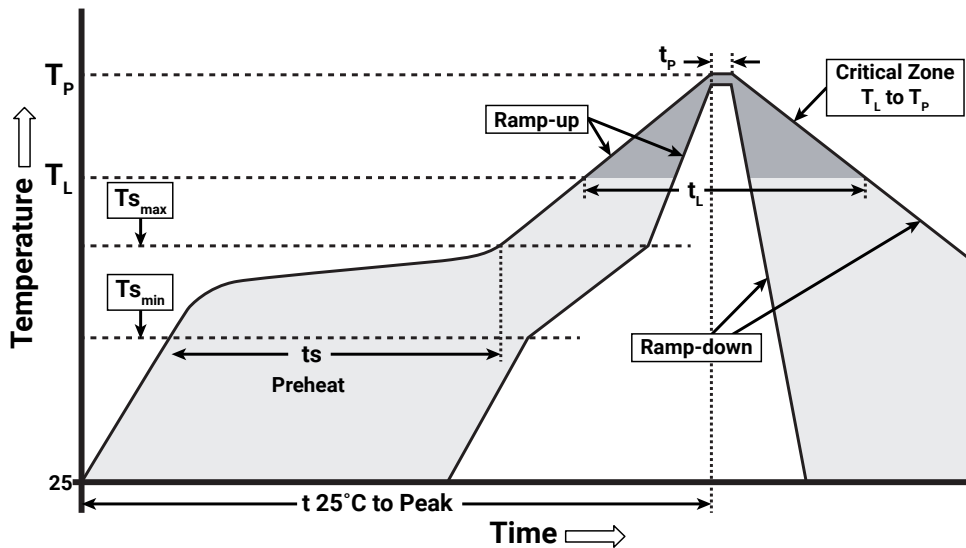

IPC/JEDEC J-STD-020C

Profile Feature	Lead-Free Solder
Temperature Min. ( $T_{s_{min}}$ )	150 °C
Temperature Max. ( $T_{s_{max}}$ )	200 °C
Time (ts) from $T_{s_{min}}$ to $T_{s_{max}}$	60-120 seconds
Ramp-Up Rate ( $T_L$ to $T_P$ )	3 °C/second
Liquidus Temperature ( $T_L$ )	217 °C
Time ( $t_L$ ) Maintained Above $T_L$	60-150 seconds
Peak Package Body Temperature ( $T_P$ )	260 °C max.
Time ( $t_p$ ) Within 5 °C of the Specified Classification Temperature ( $T_c$ )	30 seconds max.
Ramp-Down Rate ( $T_P$ to $T_L$ )	6 °C/second max.
Time 25 °C to Peak Temperature	8 minutes max.

Note: All temperatures refer to the topside of the package, measured on the package body surface.

## NOTES

### Measurements

The luminous flux, radiant power, chromaticity, forward voltage and CRI measurements in this document are binning specifications only and solely represent product measurements as of the date of shipment. These measurements will change over time based on a number of factors that are not within Cree Venture's control and are not intended or provided as operational specifications for the products. Calculated values are provided for informational purposes only and are not intended or provided as specifications.

### Pre-Release Qualification Testing

Please read the [J Series Reliability Overview](#) for the details of the pre-release qualification testing for J Series LEDs.

### Lumen Maintenance

Cree Venture uses standardized IES LM-80-08 and TM-21-11 methods for collecting long-term data and extrapolating LED lumen maintenance. For information on the specific LM-80 data sets available for this LED, refer to the public [J Series LM-80 results document](#).

Please read the [Thermal Management application note](#) for details on how thermal design, ambient temperature, and drive current affect the LED junction temperature.

### Moisture Sensitivity

Cree Venture recommends keeping J Series 3030 Standard P Class LEDs in the provided, resealable moisture-barrier packaging (MBP) until immediately prior to soldering. Unopened MBP that contains J Series 3030 Standard P Class LEDs does not need special storage for moisture sensitivity.

Once the MBP is opened, J Series 3030 Standard P Class LEDs should be handled and stored as MSL 3 per JEDEC J-STD-033, meaning they have limited exposure time before damage to the LED may occur during the soldering operation. The table on the right specifies the maximum exposure time in days depending on temperature and humidity conditions. LEDs with exposure time longer than the specified maximums must be baked according to the baking conditions listed below.

Moisture Sensitivity Level	Temp.	Maximum Percent Relative Humidity				
		50%	60%	70%	80%	90%
Level 3	35 °C	8	5	1	0.5	0.5
Level 3	30 °C	11	7	1	1	1
Level 3	25 °C	14	10	2	1	1
Level 3	20 °C	20	13	2	1	1

### Baking Conditions

It is not necessary to bake all J Series 3030 Standard P Class LEDs. Only the LEDs that meet all of the following criteria must be baked:

1. LEDs that have been removed from the original MBP.
2. LEDs that have been exposed to a humid environment longer than listed in the Moisture Sensitivity section above.
3. LEDs that have not been soldered.

LEDs should be baked at 60 °C for 24 hours. LEDs may be baked in the original reels. Remove LEDs from the MBP before baking. Do not bake parts at temperatures higher than 60 °C. This baking operation resets the exposure time as defined in the Moisture Sensitivity section above.

## NOTES - CONTINUED

---

### RoHS Compliance

The levels of RoHS restricted materials in this product are below the maximum concentration values (also referred to as the threshold limits) permitted for such substances, or are used in an exempted application, in accordance with EU Directive 2011/65/EC (RoHS2), as implemented January 2, 2013. RoHS Declarations for this product can be obtained from your Cree representative or from the [Product Ecology](#) section of the Cree LED website.

### REACH Compliance

REACH substances of very high concern (SVHCs) information is available for this product. Since the European Chemical Agency (ECHA) has published notice of their intent to frequently revise the SVHC listing for the foreseeable future, please contact a Cree representative to insure you get the most up-to-date REACH SVHC Declaration. REACH banned substance information (REACH Article 67) is also available upon request.

### UL® Recognized Component

This product meets the requirements to be considered a UL Recognized Component with Level 4 enclosure consideration. The LED package or a portion thereof has been investigated as a fire and electrical enclosure per ANSI/UL 8750.

### Vision Advisory

WARNING: Do not look at an exposed lamp in operation. Eye injury can result. For more information about LEDs and eye safety, please refer to the [J Series LED Eye Safety application note](#).

## MECHANICAL DIMENSIONS

Thermal vias, if present, are not shown on these drawings.  
 All measurements are  $\pm 0.2$  mm unless otherwise indicated.

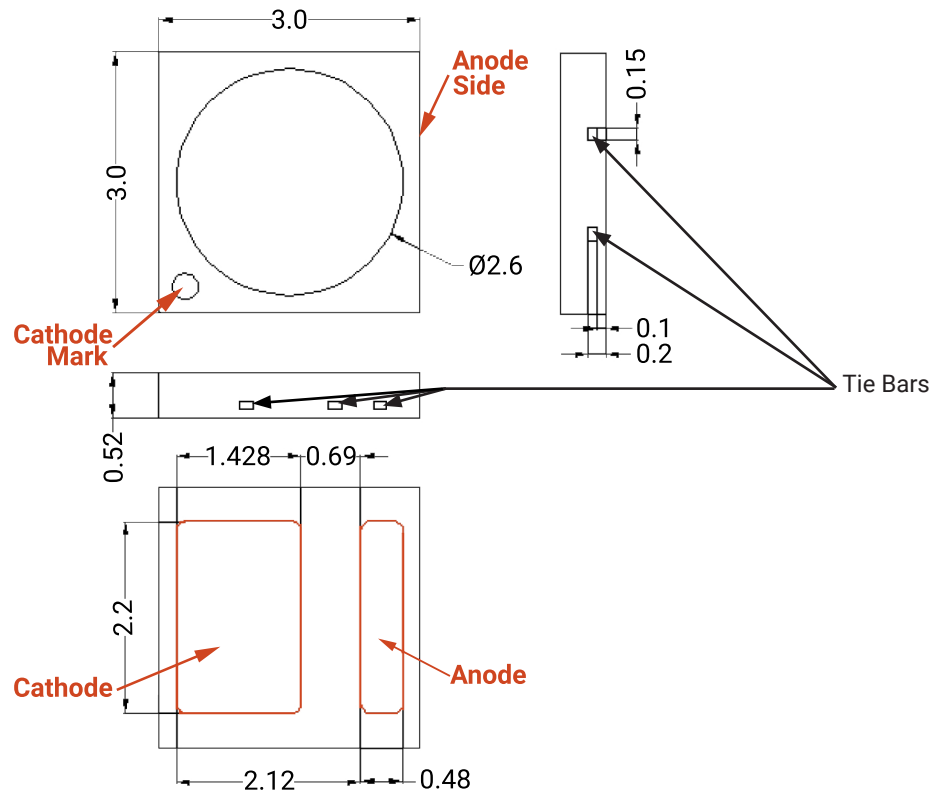

All measurements are  $\pm 0.1$  mm unless otherwise indicated.

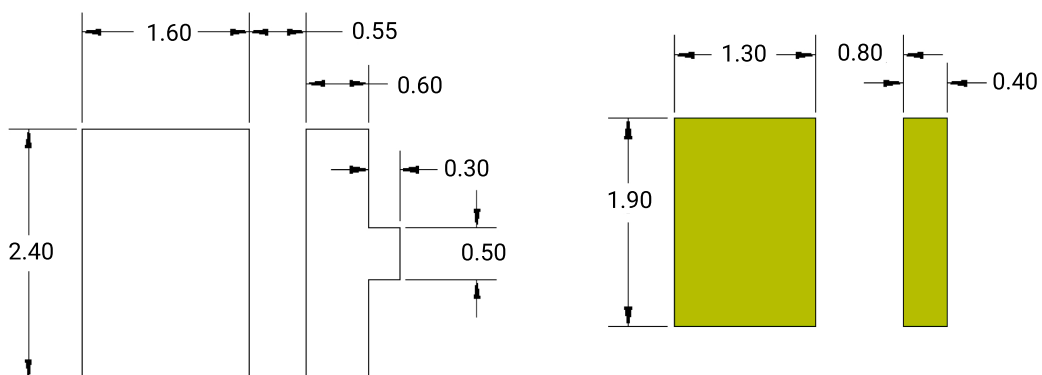

**Recommended Solder Pad**

**Recommended Stencil Pattern  
 (Shaded Area Is Open)**



TAPE & REEL

All Cree Venture carrier tapes conform to EIA-481D, Automated Component Handling Systems Standard.

All dimensions in mm.

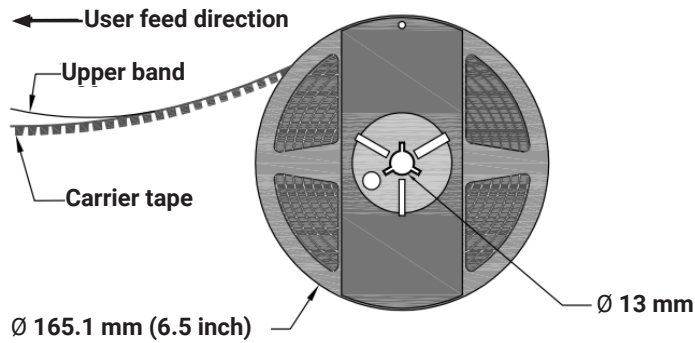
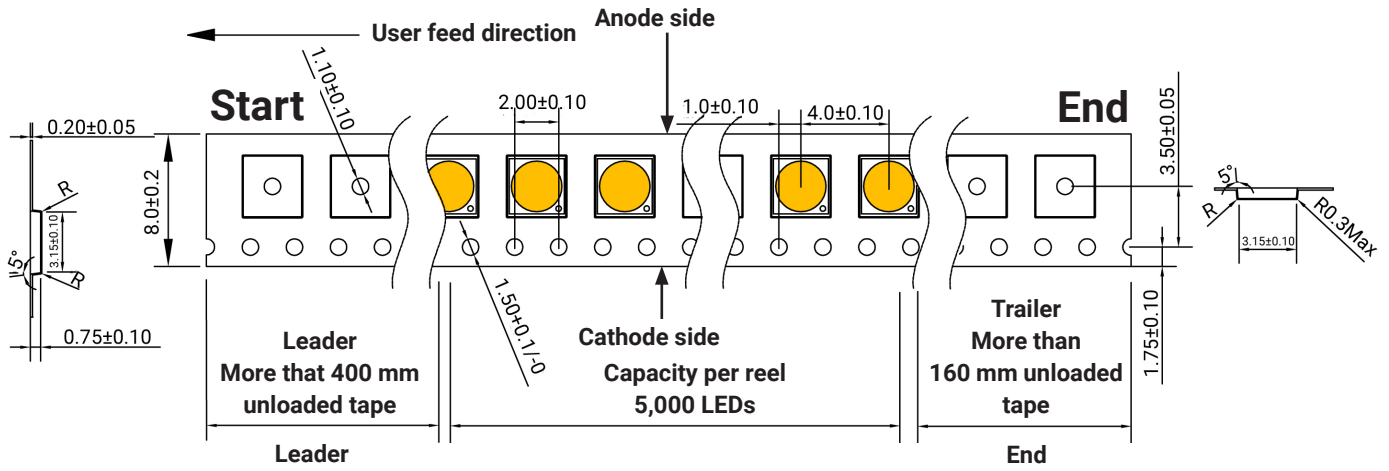

## PACKAGING

### Unpackaged Reel

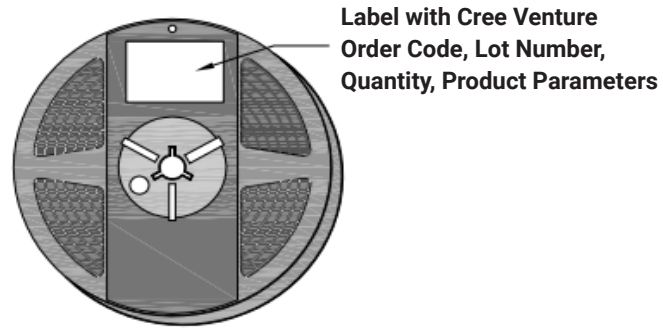

### Packaged Reel

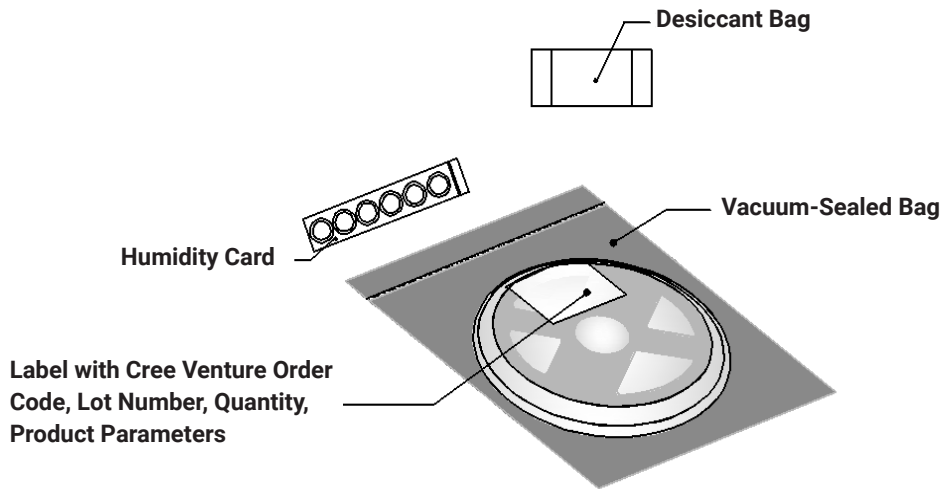

## PACKAGING - CONTINUED

J Series 3030 Standard P Class LEDs are packaged in boxes for shipment. Box sizes and the number of reels per box are as follows.

Box	Box Dimensions	Maximum Number of Reels per Box
1	250 x 210 x 30 mm	2
2	250 x 210 x 50 mm	4
3	530 x 230 x 275 mm	44
4	530 x 443 x 275 mm	88

Each box has at least one label (shown as a white square in the diagrams below) showing the order code, lot number, quantity, and product parameters.

**Box 1**

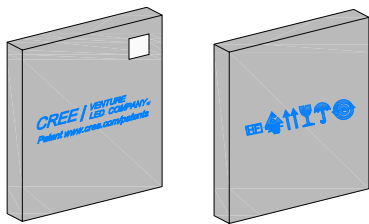

**Box 2**

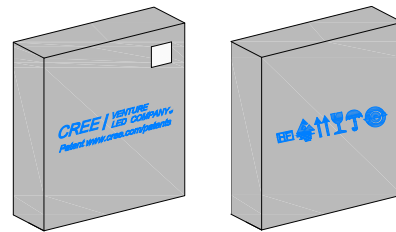

**Box 3**

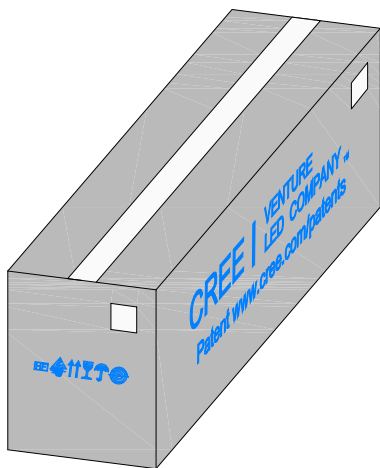

**Box 4**

