

A

9225

92x92x25mm(3.62"x3.62"x1")



HOUSING	Aluminum Die Casting, Painted Black
IMPELLER	Thermoplastic PBT, UL94V-0
BEARING	Ball or Sleeve
OPERATING TEMPERATURE	-10°C to + 70°C
INSULATION	Class A
OPERATING VOLTAGE RANGE	85 VAC to 125 VAC for 115V Type 185 VAC to 245 VAC for 230V Type
DIELECTRIC STRENGTH	5mA Max. at 1500 VAC for 1 second
INSULATION RESISTANCE	10M Ω min. @500 VDC
MOTOR TYPE	Shaded Pole Motor
SAFETY	Impedance Protected
TERMINATION	Terminals or Lead Wire
WEIGHT	300 g
ROHS COMPLIANCE	Yes
IP LEVEL	IP21 (Special IP Rating On Request)

92mm

SPECIFICATION

MODEL NO.	RATED VOLTAGE(V)	RATED CURRENT(A)	INPUT POWER(W)	SPEED (RPM)	MAX. AIR PRESSURE		MAX. AIR FLOW		NOISE dB(A) @1M
					inchH2O	mmH2O	CFM	m3/min	
A9225V1H	115	0.14/0.11	11/9	2700/3100	0.18/0.26	4.57/6.60	30/36	0.85/1.0	40/45
A9225V2H	230	0.07/0.06	12/10	2700/3100	0.18/0.26	4.57/6.60	30/36	0.85/1.0	40/45

DIMENSION

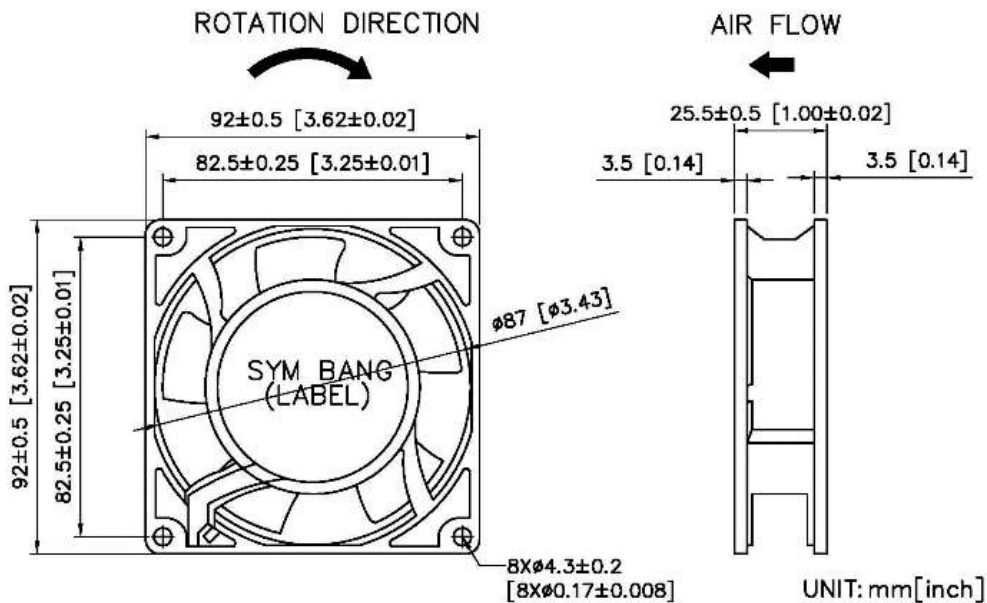

SYMBANG

AIR PERFORMANCE

