



ProLight PQ2N-4LxE
4W Power LED
Technical Datasheet
Version: 3.5

ProLight Opto ® PQ2N Series

Features

- Best Moisture Sensitivity:JEDEC Level 1
- RoHS compliant
- Very wide Viewing Angle

Main Applications

- Commercial Lighting
- Indoor Lighting
- Outdoor Lighting
- Architectural
- Horticulture
- Consumer Portable
- High-End Portable

Introduction

- ProLight 1616, is one of the smallest high power LED footprint available by ProLight Opto, has offered extended solid-state lighting design possibilities. The 1616's combination of consistent design across all configurations and its small size permit improved color mixing and optical control, compared to the larger 3535 LED. ProLight 1616 is designed with ProLight unique packaging technology which providing high stability reliability.
- 1616 qualifies as the JEDEC Level 1 MSL sensitivity level and suitable for SMD process, Pb free reflow soldering capability, and full compliance with EU education of Hazardous Substances (RoHS) legislation.

Emitter Mechanical Dimensions

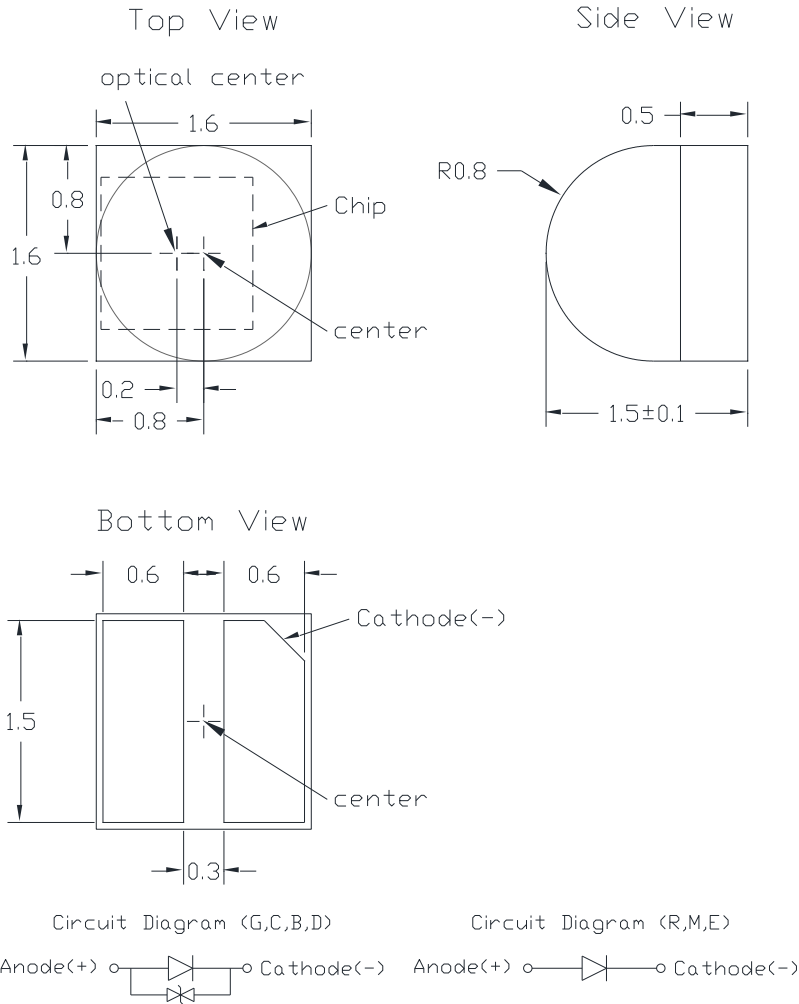

Notes:

1. Drawing not to scale.
2. All dimensions are in millimeters.
3. Unless otherwise indicated, tolerances are $\pm 0.10\text{mm}$.
4. Please do not solder the emitter by manual hand soldering, otherwise it will damage the emitter.
5. **Please do not use a force of over 0.3kgf impact or pressure on the lens of the LED, otherwise it will cause a catastrophic failure.**

Flux Characteristics, $T_j = 25^\circ\text{C}$

Color	Part Number Emitter	Luminous Flux or Power					
		@350mA		Refer @700mA		Refer @1000mA	
		Min.	Typ.	Min.	Typ.	Min.	Typ.
Red	PQ2N-4LRE	50 lm	65 lm	87.5 lm	113 lm	116 lm	150 lm
Green	PQ2N-4LGE	90 lm	130 lm	146 lm	202 lm	191 lm	250 lm
Cyan	PQ2N-4LCE	70 lm	78 lm	114 lm	127 lm	149 lm	166 lm
Blue	PQ2N-4LBE	23.5 lm	40 lm	38 lm	65 lm	50 lm	85 lm
Royal Blue	PQ2N-4LDE	435 mW	515 mW	740 mW	878 mW	980 mW	1157 mW
Crimson	PQ2N-4LME	335 mW	375 mW	586 mW	652 mW	777 mW	865 mW
Cherry Red	PQ2N-4LEE	225 mW	240 mW	391 mW	417 mW	519 mW	554 mW

- ProLight maintains a tolerance of $\pm 7\%$ on flux and power measurements.
- Please do not drive at rated current more than 1 second without proper heat sink.

Electrical Characteristics, $T_j = 25^\circ\text{C}$

Color	Forward Voltage V_F (V)					Thermal Resistance Junction to Slug ($^\circ\text{C}/\text{W}$)
	Min.	@350mA		Refer @700mA	Refer @1000mA	
		Typ.	Max.	Typ.	Typ.	
Red	1.75	2.15	3.00	2.40	2.60	5
Green	2.60	3.10	3.60	3.40	3.60	6
Cyan	2.85	3.10	3.60	3.40	3.60	6
Blue	2.85	3.10	3.60	3.40	3.60	6
Royal Blue	2.85	3.10	3.60	3.40	3.60	6
Crimson	1.75	2.15	3.00	2.40	2.60	6
Cherry Red	1.50	2.00	2.75	2.30	2.50	6

- ProLight maintains a tolerance of $\pm 0.1\text{V}$ for Voltage measurements.

Optical Characteristics at 350mA, T_j = 25°C

Radiation Pattern	Color	Dominant Wavelength λ_D , Peak Wavelength ^[1] λ_P			Total included Angle (degrees)	Viewing Angle (degrees)
		Min.	Typ.	Max.	$\theta_{0.90V}$	$2 \theta_{1/2}$
Lambertian	Red	610 nm	620.5 nm	631 nm	160	130
	Green	515 nm	525 nm	535 nm	160	130
	Cyan	495 nm	505 nm	515 nm	160	130
	Blue	465 nm	475 nm	485 nm	160	130
	Royal Blue	450 nm	455 nm	460 nm	160	130
	Crimson ^[1] ^[2]	650 nm	660 nm	670 nm	160	130
	Cherry Red ^[1]	720 nm	730 nm	740 nm	160	130

- ProLight maintains a tolerance of ± 1 nm for dominant wavelength measurements.
- ^[1] Crimson, Cherry Red product is binned by peak wavelength rather than dominant wavelength.
- ^[2] The peak wavelength of 660nm should contain the dominant wavelength of around 640nm.

Absolute Maximum Ratings

Parameter	Red/Green/Cyan/Blue/ Royal Blue/Crimson/Cherry Red
DC Forward Current (mA)	1000
Peak Pulsed Forward Current (mA)	1500 (less than 1/10 duty cycle@1KHz)
ESD Sensitivity (HBM per MIL-STD-883E Method 3015.7)	4KV
LED Junction Temperature	125°C
Operating Board Temperature at Maximum DC Forward Current	-40°C - 105°C
Storage Temperature	-40°C - 120°C
Soldering Temperature	JEDEC 020c 260°C
Allowable Reflow Cycles	3
Reverse Voltage	Not designed to be driven in reverse bias

Radiometric Power Bin Structure at 350mA

Color	Bin Code	Minimum Radiometric Power (mW)	Maximum Radiometric Power (mW)	Available Color Bins
Royal Blue	Q	435	515	All
	R	515	635	[1]
Crimson	P	335	435	All
	Q	435	515	[1]
Cherry Red	M	225	275	All
	N	275	335	[1]



- ProLight maintains a tolerance of $\pm 7\%$ on flux and power measurements.
- The flux bin of the product may be modified for improvement without notice.
- ^[1] The rest of color bins are not 100% ready for order currently. Please ask for quote and order possibility.

Photometric Luminous Flux Bin Structure at 350mA

Color	Bin Code	Minimum Photometric Flux (lm)	Maximum Photometric Flux (lm)	Available Color Bins
Red	S1	50	60	4
	S2	60	70	4
	T1	70	80	2
	T2	80	90	2
	U1	90	100	[1]
Green	U1	90	100	[1]
	U2	100	110	All
	V1	110	120	All
	V2	120	130	All
	W1	130	140	[1]
	W2	140	155	[1]
Cyan	T1	70	80	All
	T2	80	90	[1]
Blue	P	23.5	30.6	2,3
	Q	30.6	39.8	4,5
	R	39.8	51.8	[1]

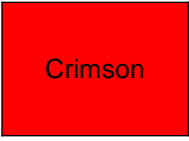

- ProLight maintains a tolerance of $\pm 7\%$ on flux and power measurements.
- The flux bin of the product may be modified for improvement without notice.
- ^[1] The rest of color bins are not 100% ready for order currently. Please ask for quote and order possibility.

Peak Wavelength Bin Structure

Color	Bin Code	Minimum Peak Wavelength (nm)	Maximum Peak Wavelength (nm)
	1	650	655
	2	655	660
	3	660	665
	4	665	670
	1	720	740

- ProLight maintains a tolerance of ± 1 nm for peak wavelength measurements.

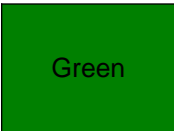
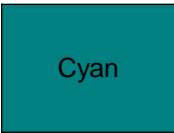





Dominant Wavelength Bin Structure

Color	Bin Code	Minimum Dominant Wavelength (nm)	Maximum Dominant Wavelength (nm)
	2	610.0	620.5
	4	620.5	631.0
	A	515	520
	1	520	525
	2	525	530
	3	530	535
	A	495	500
	1	500	505
	2	505	510
	3	510	515
	2	465	470
	3	470	475
	4	475	480
	5	480	485
	5	450	455
	6	455	460

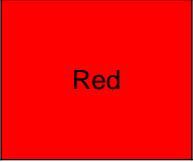
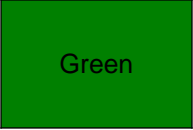
- ProLight maintains a tolerance of ± 1 nm for dominant wavelength measurements.

Note: Although several bins are outlined, product availability in a particular bin varies by production run and by product performance. Not all bins are available in all colors.

Forward Voltage Bin Structure at 350mA

Color	Bin Code	Minimum Voltage (V)	Maximum Voltage (V)
	A	1.75	2.00
	B	2.00	2.25
	D	2.25	2.50
	E	2.50	2.75
	F	2.75	3.00
	a	2.60	2.85
	A	2.85	3.10
	B	3.10	3.35
	D	3.35	3.60
	A	2.85	3.10
	B	3.10	3.35
	D	3.35	3.60
	A	2.85	3.10
	B	3.10	3.35
	D	3.35	3.60
	A	2.85	3.10
	B	3.10	3.35
	D	3.35	3.60
	A	1.75	2.00
	B	2.00	2.25
	D	2.25	2.50
	E	2.50	2.75
	F	2.75	3.00
	a	1.50	1.75
	A	1.75	2.00
	B	2.00	2.25
	D	2.25	2.50
	E	2.50	2.75

- ProLight maintains a tolerance of $\pm 0.1V$ for Voltage measurements.

Note: Although several bins are outlined, product availability in a particular bin varies by production run and by product performance. Not all bins are available in all colors.

Color Spectrum, $T_j = 25^\circ\text{C}$

1. Royal Blue 、 Blue 、 Cyan 、 Green 、 Red 、 Crimson 、 Cherry Red

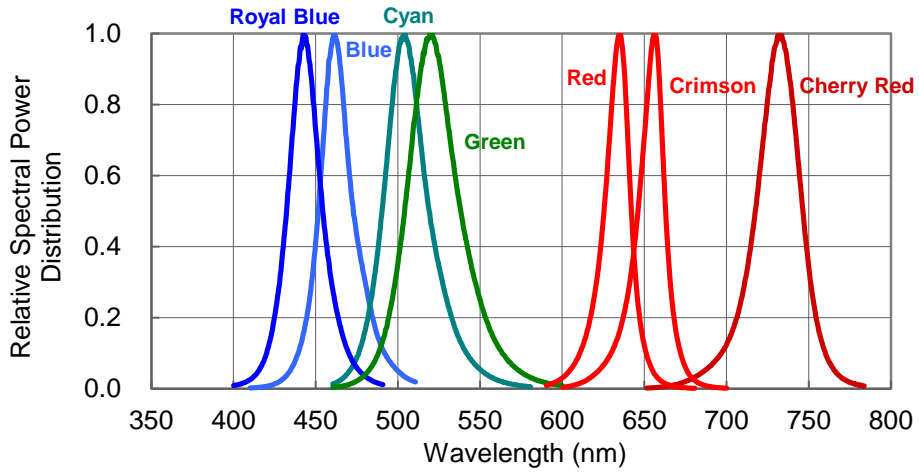

Light Output Characteristics

Relative Light Output vs. Junction Temperature at 350mA

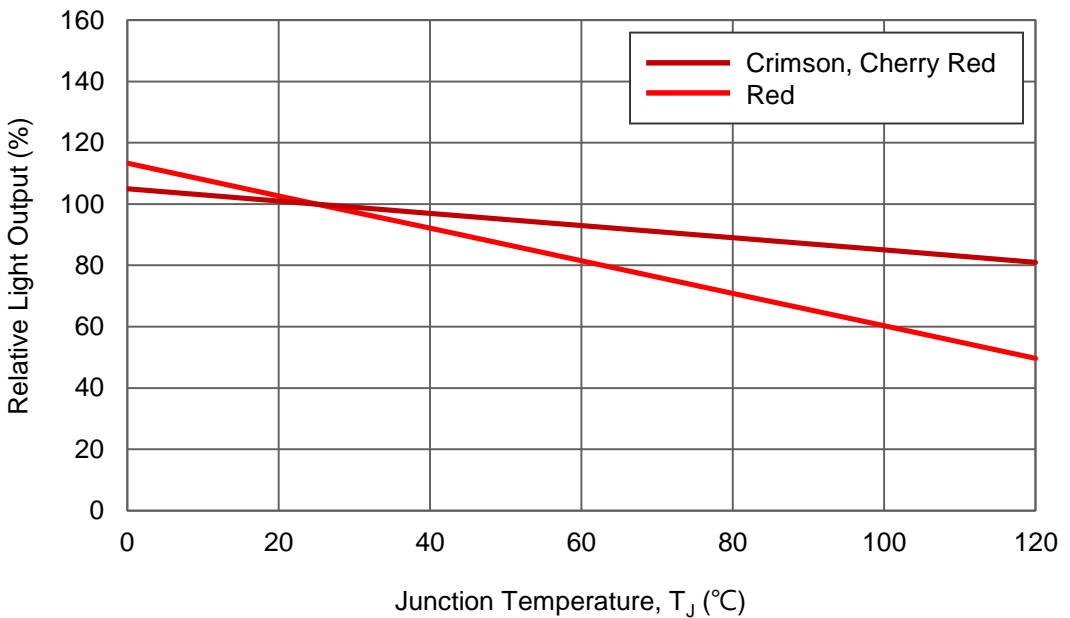
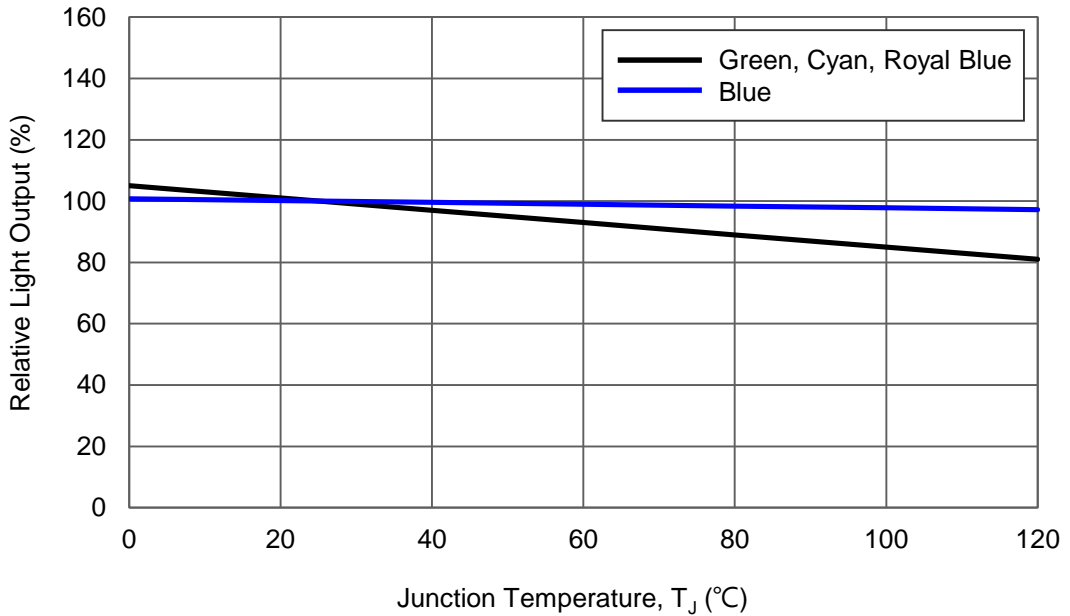

Forward Current Characteristics, $T_j = 25^\circ\text{C}$

1. Forward Voltage vs. Forward Current

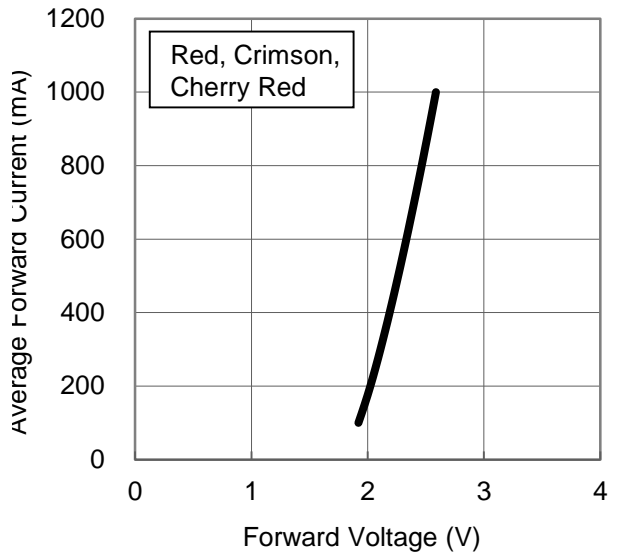
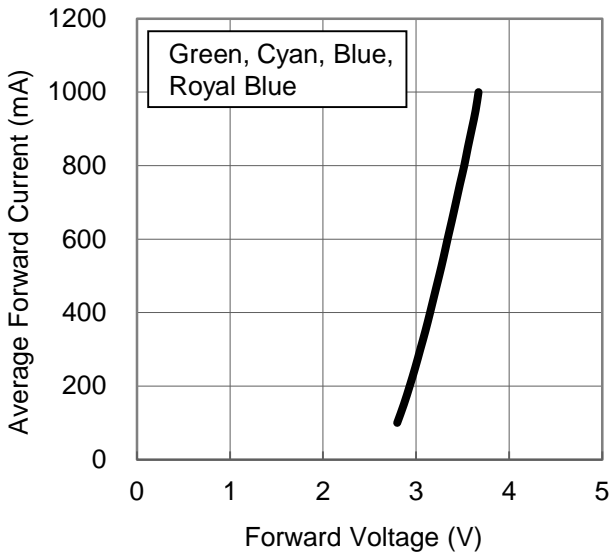

2. Forward Current vs. Normalized Relative Luminous Flux

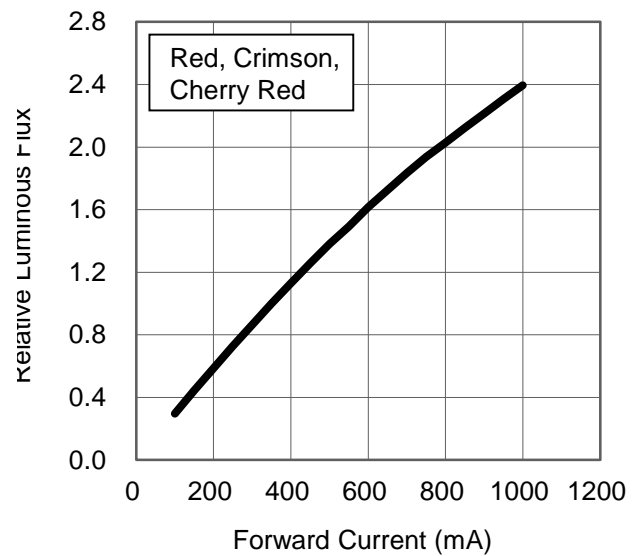
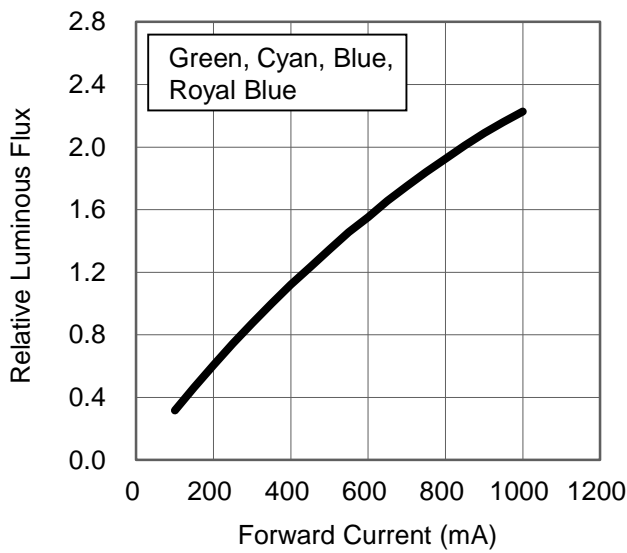

Typical Representative Spatial Radiation Pattern

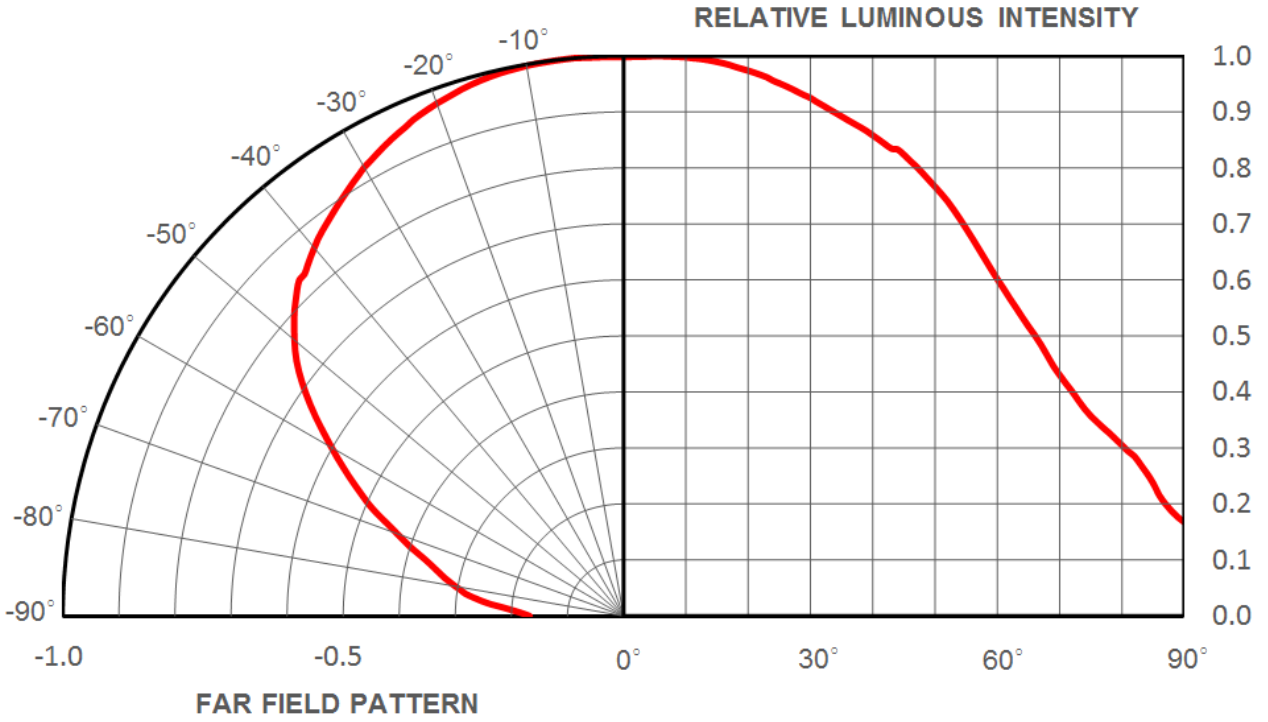

Moisture Sensitivity Level - JEDEC Level 1

Level	Floor Life		Soak Requirements			
			Standard		Accelerated Environment	
	Time	Conditions	Time (hours)	Conditions	Time (hours)	Conditions
1	Unlimited	≤30°C / 85% RH	168 +5/-0	85°C / 85% RH	NA	NA

- The standard soak time includes a default value of 24 hours for semiconductor manufacture's exposure time (MET) between bake and bag and includes the maximum time allowed out of the bag at the distributor's facility.
- Table below presents the moisture sensitivity level definitions per IPC/JEDEC's J-STD-020C.

Level	Floor Life		Soak Requirements			
			Standard		Accelerated Environment	
	Time	Conditions	Time (hours)	Conditions	Time (hours)	Conditions
1	Unlimited	≤30°C / 85% RH	168 +5/-0	85°C / 85% RH	NA	NA
2	1 year	≤30°C / 60% RH	168 +5/-0	85°C / 60% RH	NA	NA
2a	4 weeks	≤30°C / 60% RH	696 +5/-0	30°C / 60% RH	120 +1/-0	60°C / 60% RH
3	168 hours	≤30°C / 60% RH	192 +5/-0	30°C / 60% RH	40 +1/-0	60°C / 60% RH
4	72 hours	≤30°C / 60% RH	96 +2/-0	30°C / 60% RH	20 +0.5/-0	60°C / 60% RH
5	48 hours	≤30°C / 60% RH	72 +2/-0	30°C / 60% RH	15 +0.5/-0	60°C / 60% RH
5a	24 hours	≤30°C / 60% RH	48 +2/-0	30°C / 60% RH	10 +0.5/-0	60°C / 60% RH
6	Time on Label (TOL)	≤30°C / 60% RH	Time on Label (TOL)	30°C / 60% RH	NA	NA

Qualification Reliability Testing

Stress Test	Stress Conditions	Stress Duration	Failure Criteria
Room Temperature Operating Life (RTOL)	25°C, $I_F = \text{max DC}$ (Note 1)	1000 hours	Note 2
Wet High Temperature Operating Life (WHTOL)	85°C/60%RH, $I_F = \text{max DC}$ (Note 1)	1000 hours	Note 2
Wet High Temperature Storage Life (WHTSL)	85°C/85%RH, non-operating	1000 hours	Note 2
High Temperature Storage Life (HTSL)	110°C, non-operating	1000 hours	Note 2
Low Temperature Storage Life (LTSL)	-40°C, non-operating	1000 hours	Note 2
Non-operating Temperature Cycle (TMCL)	-40°C to 120°C, 30 min. dwell, <5 min. transfer	200 cycles	Note 2
Mechanical Shock	1500 G, 0.5 msec. pulse, 5 shocks each 6 axis		Note 3
Natural Drop	On concrete from 1.2 m, 3X		Note 3
Variable Vibration Frequency	10-2000-10 Hz, log or linear sweep rate, 20 G about 1 min., 1.5 mm, 3X/axis		Note 3
Solder Heat Resistance (SHR)	260°C ± 5°C, 10 sec.		Note 3
Solderability	Steam age for 16 hrs., then solder dip at 260°C for 5 sec.		Solder coverage on lead

Notes:

1. Depending on the maximum derating curve.
2. Criteria for judging failure

Item	Test Condition	Criteria for Judgement	
		Min.	Max.
Forward Voltage (V_F)	$I_F = \text{max DC}$	--	Initial Level x 1.1
Luminous Flux or Radiometric Power (Φ_V)	$I_F = \text{max DC}$	Initial Level x 0.7	--
Reverse Current (I_R)	$V_R = 5V$	--	50 μA

* The test is performed after the LED is cooled down to the room temperature.

3. A failure is an LED that is open or shorted.

Recommended Solder Pad Design

Standard Emitter

TYPE A.

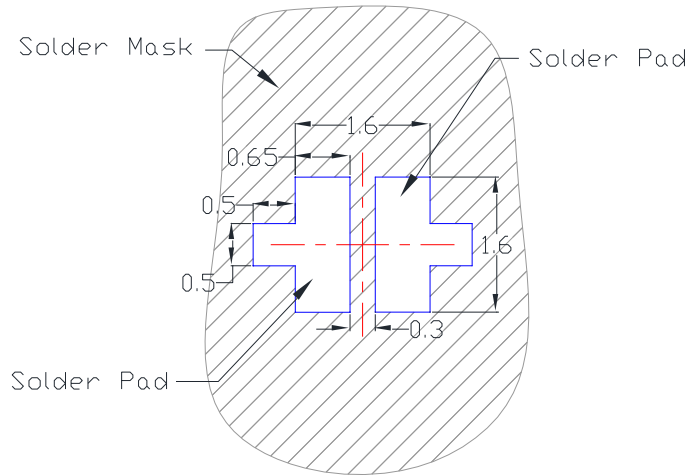

TYPE B.

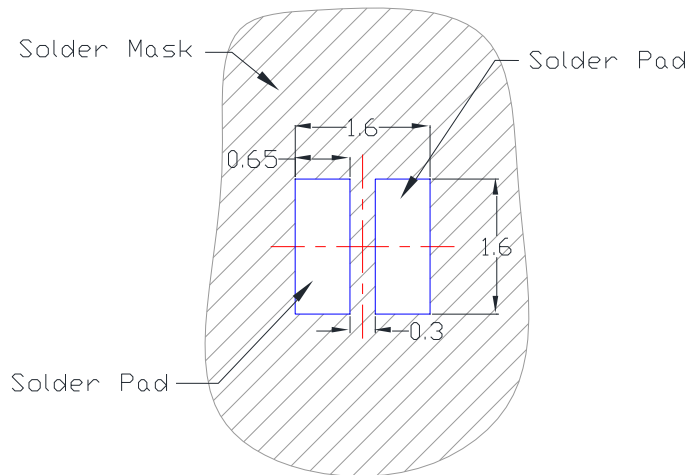

- All dimensions are in millimeters.

Reflow Soldering Condition

Profile Feature	Sn-Pb Eutectic Assembly	Pb-Free Assembly
Average Ramp-Up Rate (T_{Smax} to T_p)	3°C / second max.	3°C / second max.
Preheat <ul style="list-style-type: none"> – Temperature Min (T_{Smin}) – Temperature Max (T_{Smax}) – Time (t_{Smin} to t_{Smax}) 	100°C 150°C 60-120 seconds	150°C 200°C 60-180 seconds
Time maintained above: <ul style="list-style-type: none"> – Temperature (T_L) – Time (t_L) 	183°C 60-150 seconds	217°C 60-150 seconds
Peak/Classification Temperature (T_p)	240°C	260°C
Time Within 5°C of Actual Peak Temperature (t_p)	10-30 seconds	20-40 seconds
Ramp-Down Rate	6°C/second max.	6°C/second max.
Time 25°C to Peak Temperature	6 minutes max.	8 minutes max.

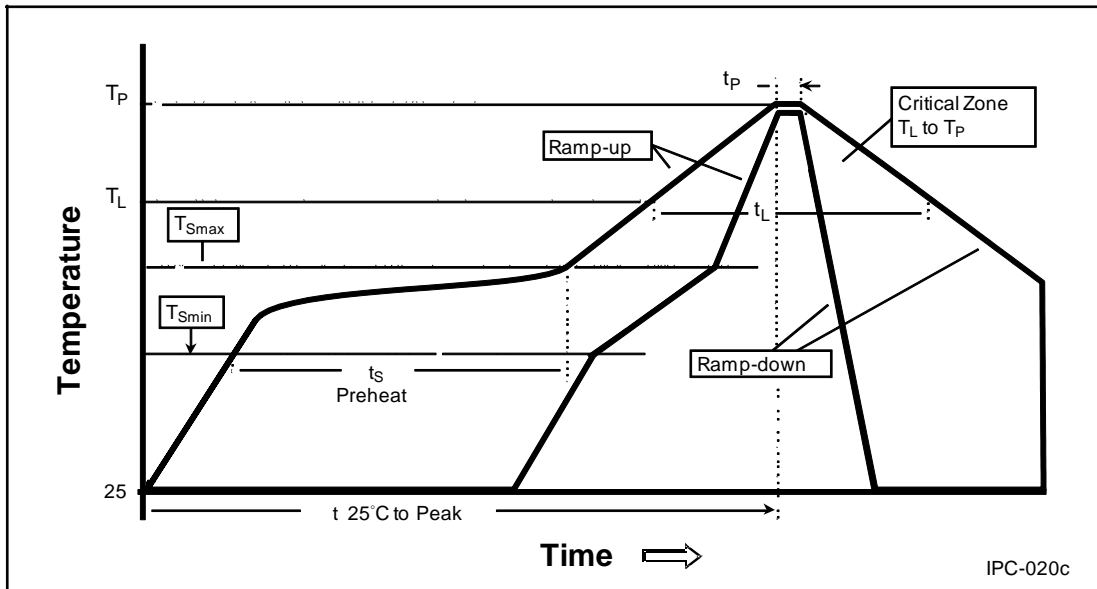

- We recommend using the M705-S101-S4 solder paste from SMIC (Senju Metal Industry Co., Ltd.) for lead-free soldering.
- Do not use solder pastes with post reflow flux residue > 47%. (58Bi-42Sn eutectic alloy, etc) This kind of solder pastes may cause a reliability problem to LED.
- All temperatures refer to topside of the package, measured on the package body surface.
- Repairing should not be done after the LEDs have been soldered. When repairing is unavoidable, a double-head soldering iron should be used. It should be confirmed beforehand whether the characteristics of the LEDs will or will not be damaged by repairing.
- Reflow soldering should not be done more than three times.
- When soldering, do not put stress on the LEDs during heating.
- After soldering, do not warp the circuit board.

Emitter Reel Packaging

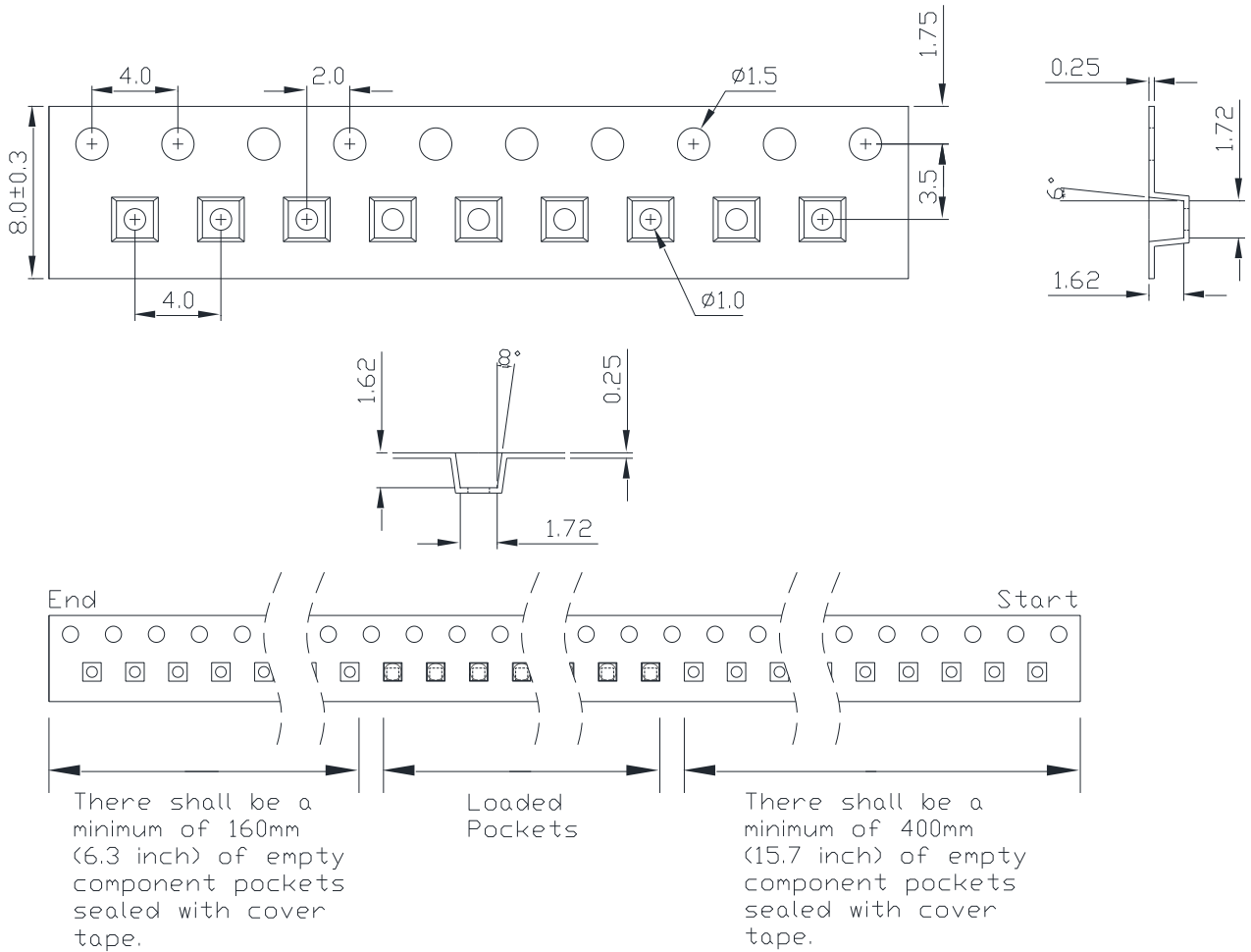

Notes:

1. Drawing not to scale.
2. All dimensions are in millimeters.
3. Unless otherwise indicated, tolerances are ± 0.10 mm.

Emitter Reel Packaging

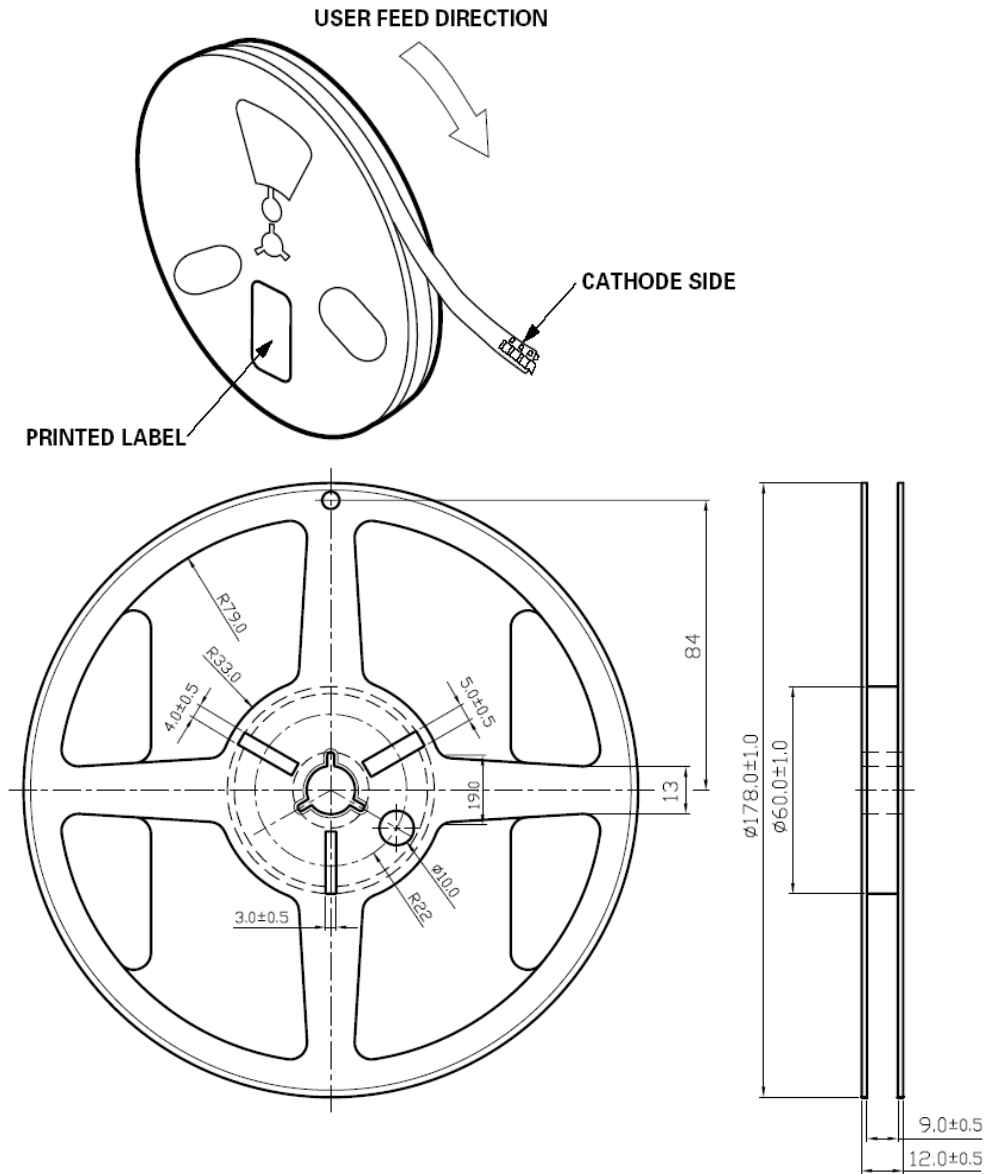

Notes:

1. Empty component pockets sealed with top cover tape.
2. 1000 and 2000 pieces per reel.
3. Drawing not to scale.
4. All dimensions are in millimeters.

Precaution for Use

- Storage
Please do not open the moisture barrier bag (MBB) more than one week. This may cause the leads of LED discoloration. We recommend storing ProLight's LEDs in a dry box after opening the MBB. The recommended storage conditions are temperature 5 to 30 °C and humidity less than 40% RH. It is also recommended to return the LEDs to the MBB and to reseal the MBB.
- The slug is is not electrically neutral. Therefore, we recommend to isolate the heat sink.
- **We recommend using the M705-S101-S4 solder paste from SMIC (Senju Metal Industry Co., Ltd.) for lead-free soldering.**
- **Do not use solder pastes with post reflow flux residue>47%. (58Bi-42Sn eutectic alloy, etc) This kind of solder pastes may cause a reliability problem to LED.**
- Any mechanical force or any excess vibration shall not be accepted to apply during cooling process to normal temperature after soldering.
- Please avoid rapid cooling after soldering.
- Components should not be mounted on warped direction of PCB.
- Repairing should not be done after the LEDs have been soldered. When repairing is unavoidable, a heat plate should be used. It should be confirmed beforehand whether the characteristics of the LEDs will or will not be damaged by repairing.
- This device should not be used in any type of fluid such as water, oil, organic solvent and etc. When cleaning is required, isopropyl alcohol should be used.
- When the LEDs are illuminating, operating current should be decide after considering the package maximum temperature.
- The appearance, specifications and flux bin of the product may be modified for improvement without notice. Please refer to the below website for the latest datasheets.
<http://www.prolightopto.com/>

Handling of Silicone Lens LEDs

Notes for handling of silicone lens LEDs

- Please do not use a force of over 0.3kgf impact or pressure on the silicone lens, otherwise it will cause a catastrophic failure.
- The LEDs should only be picked up by making contact with the sides of the LED body.
- Avoid touching the silicone lens especially by sharp tools such as Tweezers.
- Avoid leaving fingerprints on the silicone lens.
- Please store the LEDs away from dusty areas or seal the product against dust.
- When populating boards in SMT production, there are basically no restrictions regarding the form of the pick and place nozzle, except that mechanical pressure on the silicone lens must be prevented.
- Please do not mold over the silicone lens with another resin. (epoxy, urethane, etc)

