

**ebm-papst St. Georgen GmbH & Co. KG**

Hermann-Papst-Str. 1
 D-78112 St. Georgen
 Phone +49 (0) 7724 81-0
 Fax +49 (0) 7724 81-1309
 info2@de.ebmpapst.com
 www.ebmpapst.com

Nominal data

Type	5318 /2 TDHP	
Nominal voltage	VDC	48
Nominal voltage range	VDC	36 .. 72
Speed (rpm)	min ⁻¹	6000
Power consumption	W	42
Min. ambient temperature	°C	-20
Max. ambient temperature	°C	70
Air flow	m ³ /h	410
Sound power level	B	7.7
Sound pressure level	dB(A)	70

ml = Max. load · me = Max. efficiency · fa = Free air · cs = Customer specification · ce = Customer equipment
 Subject to change



Technical description

General description	Power consumption when wide open; these values may be considerably higher at the operating point.
Impeller material	Glass-fiber reinforced PA plastic
Weight	0.900 kg
Dimensions	140 x 140 x 51 mm
Housing material	Die-cast aluminum
Airflow direction	Intake over struts
Direction of rotation	Counterclockwise, viewed toward rotor
Storage	Ball bearing
Service life L10 at 40 °C	70000 h
Service life L10 at maximum temperature	35000 h
Cable	With leads AWG 20 and AWG 22, TR 64
Motor protection	Protection against reverse polarity and blocked rotor.



Product drawing

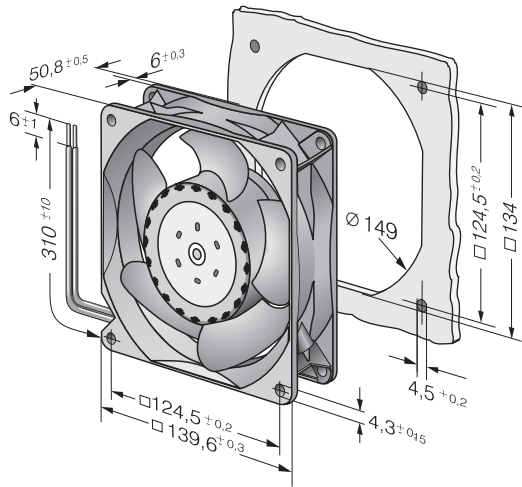

Curves: Air performance

