



# 92x92x32 mm

San Ace 92 9G type

## General Specifications

- Material ..... Frame: Plastic (Flammability: UL 94V-0), Impeller: Plastic (Flammability: UL 94V-1)
- Expected life ..... See the table below. (L10 life: 90% survival rate for continuous operation in free air at 60°C, rated voltage)  
Expected life at 40°C is for reference only.
- Motor protection function ..... Locked rotor burnout protection, Reverse polarity protection  
For details, please refer to p. 599.
- Dielectric strength ..... 50/60 Hz, 500 VAC, for 1 minute (between lead wire conductors and frame)
- Insulation resistance ..... 10 MΩ or more with a 500 VDC megger (between lead wire conductors and frame)
- Sound pressure level (SPL) ..... At 1 m away from the air inlet
- Storage temperature ..... -30 to +70°C (Non-condensing)
- Lead wire ..... ⊕Red ⊖Black or Blue  Sensor Yellow
- Mass ..... 170 g

## Specifications

The models listed below **have ribs and pulse sensors**. For models without ribs, append "1" to the end of model numbers.

Model no.	Rated voltage [V]	Operating voltage range [V]	Rated current [A]	Rated input [W]	Rated speed [min <sup>-1</sup> ]	Max. airflow [m <sup>3</sup> /min] [CFM]	Max. static pressure [Pa] [inchH <sub>2</sub> O]	SPL [dB (A)]	Operating temperature [°C]	Expected life [h]
9G0912A201	12	10.2 to 13.8	0.58	6.96	4300	2.5 88.3	115 0.462	44	-20 to +70	40000/60°C (70000/40°C)
9G0912S201			0.38	4.56	3500	2.0 70.7	77 0.309	38		
9G0912H201			0.23	2.76	2850	1.59 56.2	51 0.205	32		
9G0912M201			0.13	1.56	2100	1.2 42.4	27 0.108	25		
9G0924A201	24	20.4 to 27.6	0.3	7.2	4300	2.5 88.3	115 0.462	44	-20 to +60	
9G0924S201			0.19	4.56	3500	2.0 70.7	77 0.309	38		
9G0924H201			0.12	2.88	2850	1.59 56.2	51 0.205	32		
9G0924M201			0.08	1.92	2100	1.2 42.4	27 0.108	25		
9G0948A201	48	40.8 to 55.2	0.16	7.68	4300	2.5 88.3	115 0.462	44	-20 to +70	
9G0948S201			0.11	5.28	3500	2.0 70.7	77 0.309	38		
9G0948H201			0.08	3.84	2850	1.59 56.2	51 0.205	32		
9G0948M201			0.05	2.4	2100	1.2 42.4	27 0.108	25		

Note 1: Sensor and control options are available for selection. Refer to the table on pp. 626 to 627.

Note 2: The mark indicates Short LeadTime Service applicable models. See p. 654 for details.

## Airflow - Static Pressure Characteristics

**9G0912A201** With pulse sensor

Operating voltage range

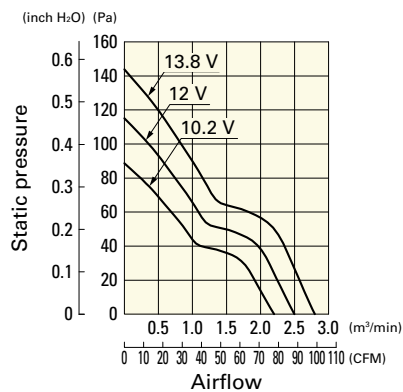

**9G0912S201** With pulse sensor

Operating voltage range

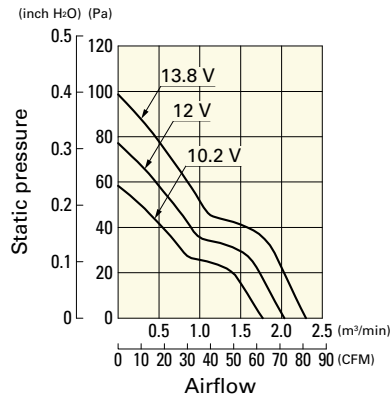

**9G0912H201** With pulse sensor

Operating voltage range

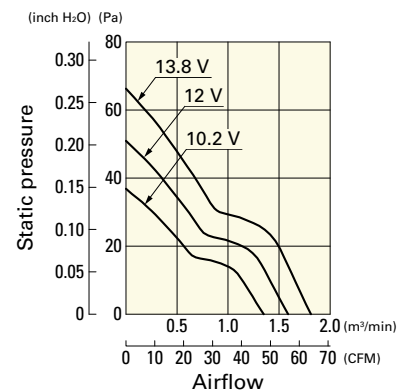

## Airflow - Static Pressure Characteristics

**9G0912M201** With pulse sensor

Operating voltage range

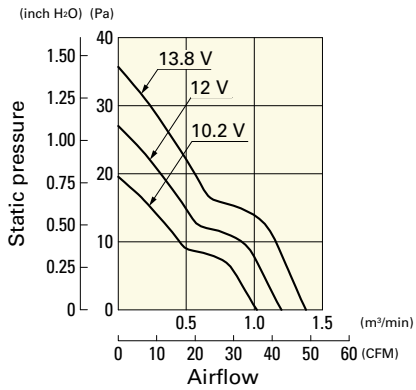

**9G0924A201** With pulse sensor

Operating voltage range

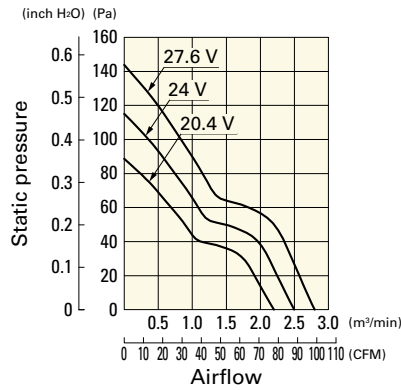

**9G0924S201** With pulse sensor

Operating voltage range

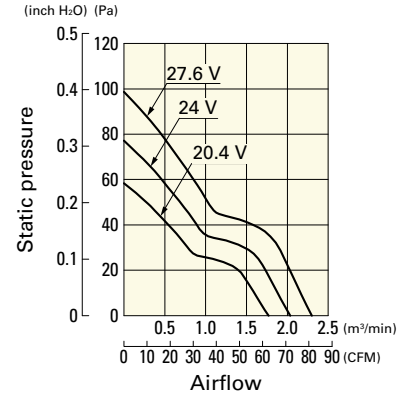

**9G0924H201** With pulse sensor

Operating voltage range

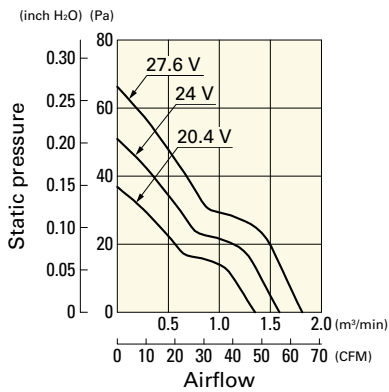

**9G0924M201** With pulse sensor

Operating voltage range

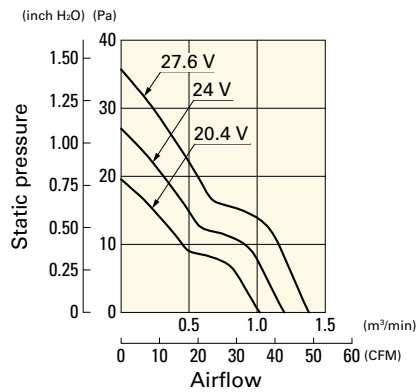

**9G0948A201** With pulse sensor

Operating voltage range

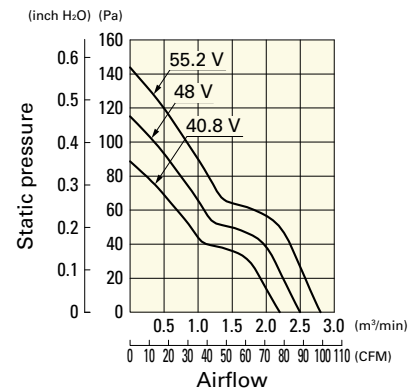

**9G0948S201** With pulse sensor

Operating voltage range

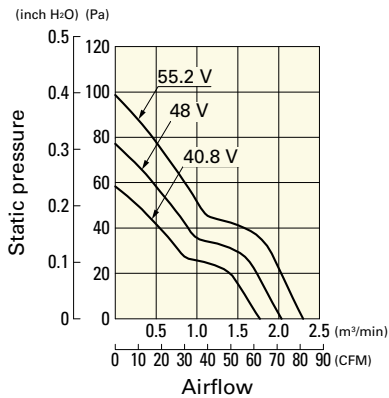

**9G0948H201** With pulse sensor

Operating voltage range

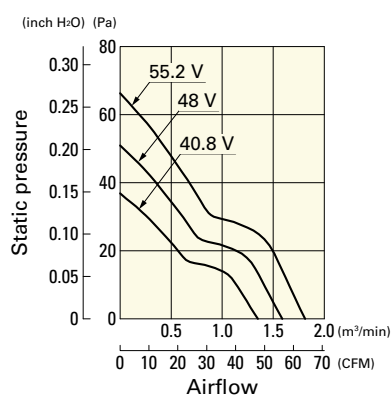

**9G0948M201** With pulse sensor

Operating voltage range

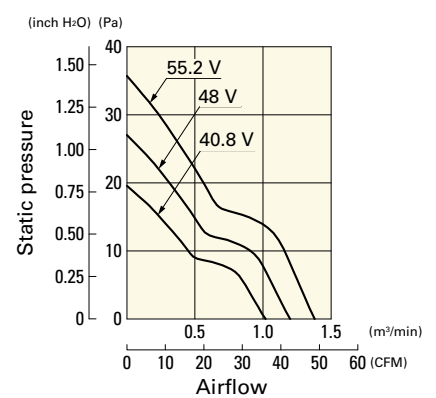

**Dimensions (unit: mm) (With ribs)**

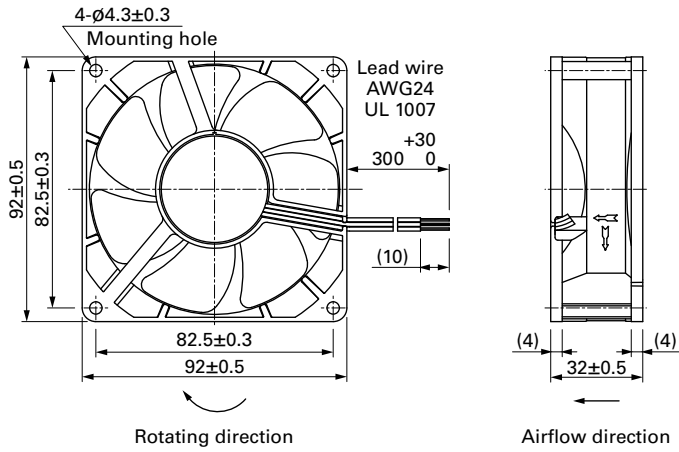

**Reference Dimensions of Mounting Holes and Vent Opening (unit: mm)**

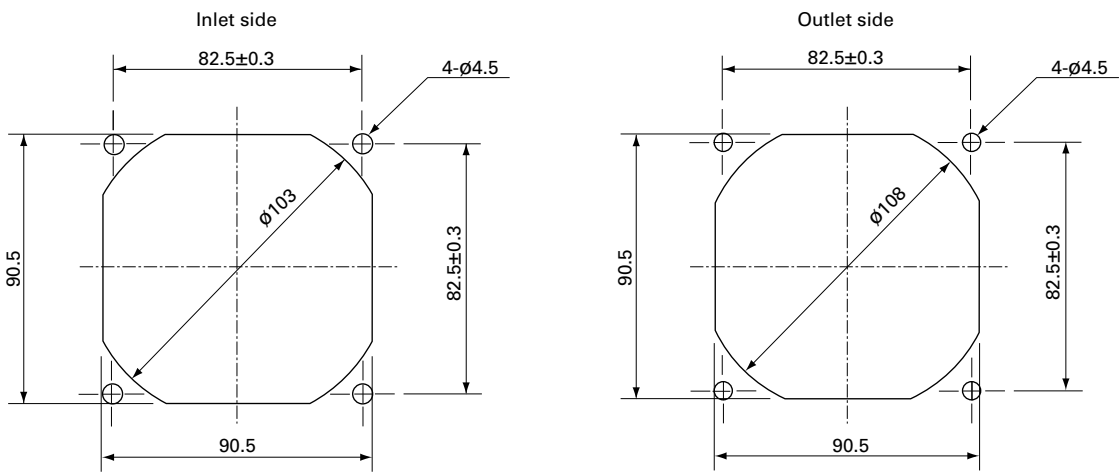

**Options**

**Finger guards** page: p. 584  
 Model no.: 109-099E, 109-099H, 109-099C

**Resin finger guards** page: p. 591  
 Model no.: 109-1001G

**Resin filter kits** page: p. 592  
 Model no.: 109-1001F13 (13PPI), 109-1001F20 (20PPI),  
 109-1001F30 (30PPI), 109-1001F40 (40PPI)