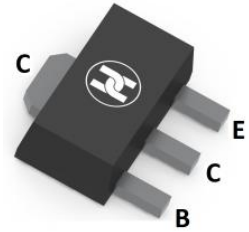
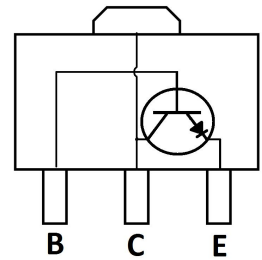

BIPOLAR TRANSISTOR (NPN)
FEATURES

- Complementary to BCX51
- High Current
- Low Voltage
- For Stages of Audio Amplifiers Application
- Surface Mount device

SOT-89

MECHANICAL DATA

- Case: SOT-89
- Case Material: Molded Plastic. UL flammability
- Classification Rating: 94V-0
- Weight: 0.055 grams (approximate)

MAXIMUM RATINGS (T_A = 25°C unless otherwise noted)

Parameter	Symbol	Value	Unit
Collector-Base Voltage	V _{CB0}	45	V
Collector-Emitter Voltage	V _{CEO}	45	V
Emitter-Base Voltage	V _{EBO}	5	V
Collector Current	I _C	1	A
Base Current	I _B	0.1	A
Peak Base Current	I _{BM}	0.2	A
Collector Power Dissipation	P _C	500	mW
Thermal Resistance From Junction To Ambient	R _{θJA}	250	°C/W
Junction Temperature	T _J	150	°C
Storage Temperature	T _{STG}	-55 ~ +150	°C

ELECTRICAL CHARACTERISTICS (T_A = 25°C unless otherwise specified)

Parameter	Symbol	Min	Typ	Max	Unit	Conditions
Collector-base breakdown voltage	V _{(BR)CBO}	45			V	I _C =100uA, I _E =0
Collector-emitter breakdown voltage	V _{(BR)CEO}	45			V	I _C =10mA, I _B =0
Emitter-base breakdown voltage	V _{(BR)EBO}	5			V	I _E =10uA, I _C =0
Collector cut-off current	I _{CB0}			0.1	uA	V _{CB} =30V, I _E =0
Emitter cut-off current	I _{EBO}			0.1	uA	V _{EB} =5V, I _C =0
DC current gain	h _{FE1} *	40				V _{CE} =2V, I _C =5mA
	h _{FE2} *	63		250		V _{CE} =2V, I _C =150mA
	h _{FE3} *	25				V _{CE} =2V, I _C =0.5A
Collector-emitter saturation voltage	V _{CE(sat)} *			0.5	V	I _C =0.5A, I _B =50mA
Base-emitter voltage	V _{BE} *			1	V	V _{CE} =2V, I _C =0.5A
Transition frequency	f _T		130		MHz	V _{CE} =5V, I _C =10mA, f=100MHz

CLASSIFICATION OF h_{FE}

Rank	A	C	D
Range	63-250	63-160	100-250
Marking	BA	BC	BD

BIPOLAR TRANSISTOR (NPN)

Typical Characteristics

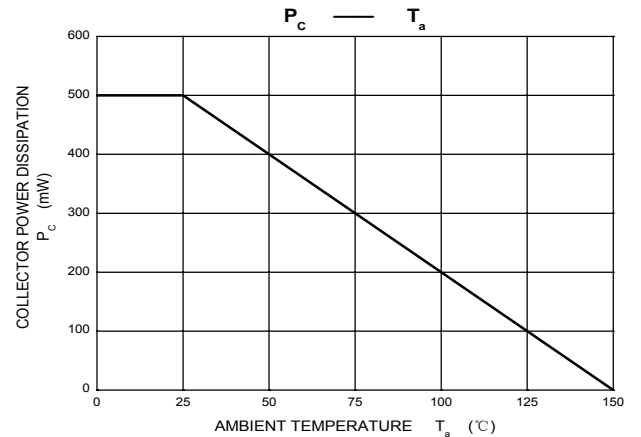
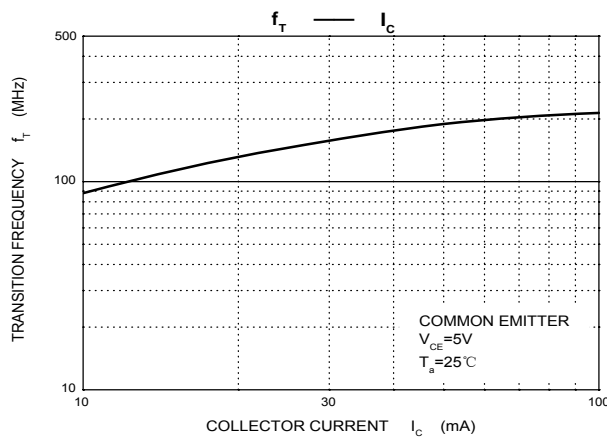
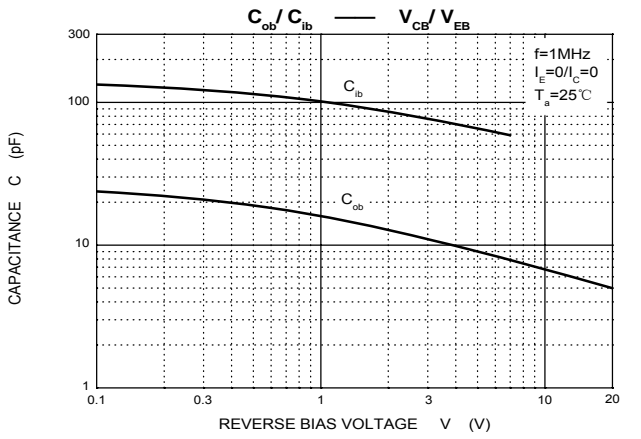
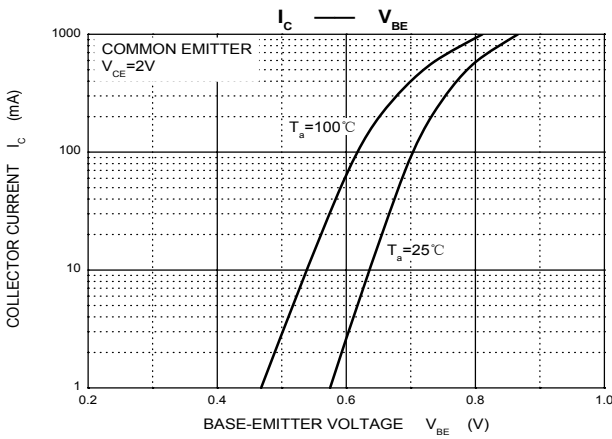
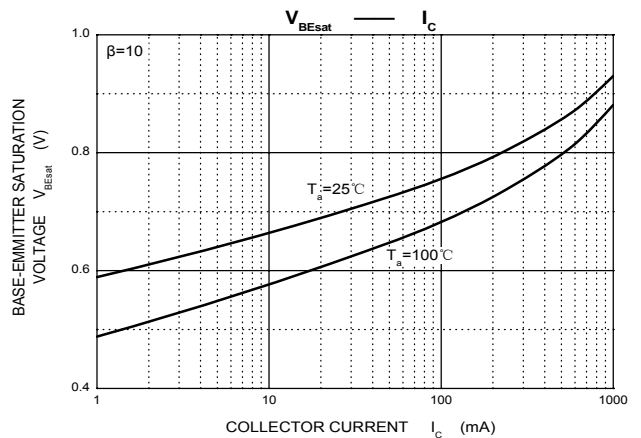
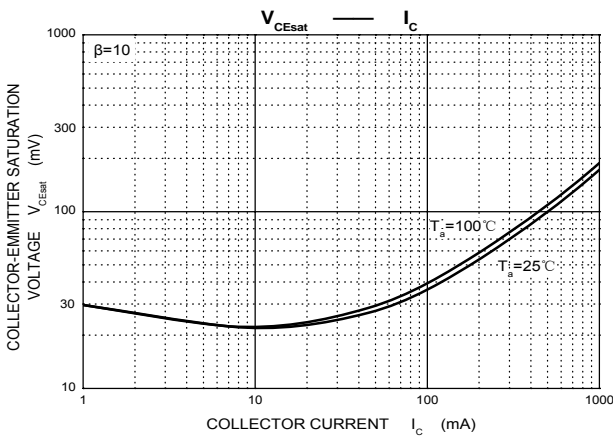
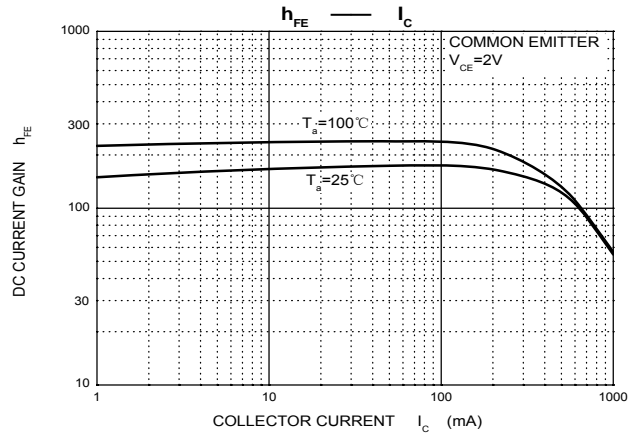
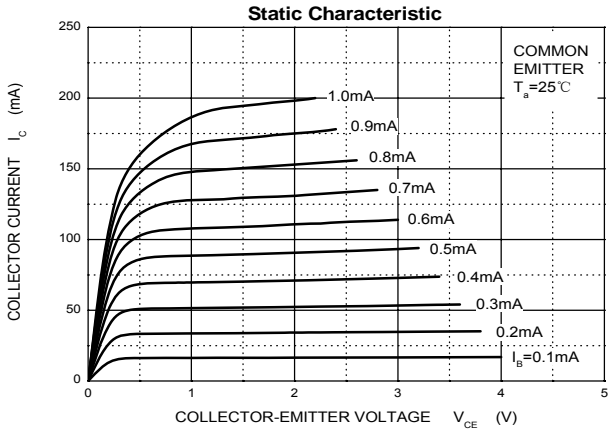

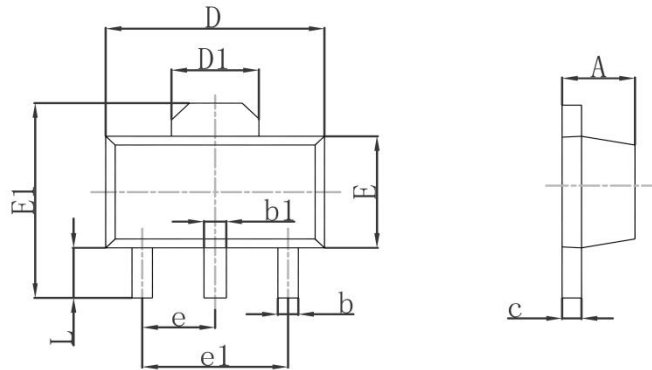
BIPOLAR TRANSISTOR (NPN)
SOT-89 Package Outline Dimensions

Symbol	Dimensions In Millimeters		Dimensions In Inches	
	Min.	Max.	Min.	Max.
A	1.400	1.600	0.055	0.063
b	0.320	0.520	0.013	0.020
b1	0.400	0.580	0.016	0.023
c	0.350	0.440	0.014	0.017
D	4.400	4.600	0.173	0.181
D1	1.550REF		0.061REF	
E	2.300	2.600	0.091	0.102
E1	3.940	4.250	0.155	0.167
e	1.500TYP		0.060TYP	
e1	3.000TYP		0.118TYP	
L	0.900	1.200	0.035	0.047

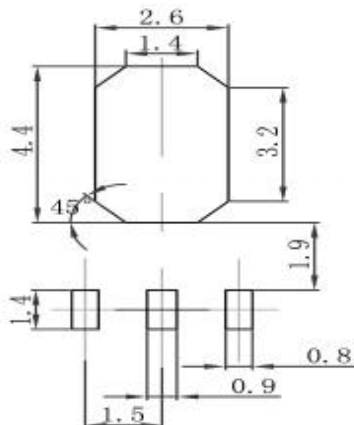
SOT-89 Suggested Pad Layout

Note:

1. Controlling dimension: in millimeters
2. General tolerance: $\pm 0.05\text{mm}$
3. The pad layout is for reference purposes only

BIPOLAR TRANSISTOR (NPN)

SOT-89 Tape and Reel

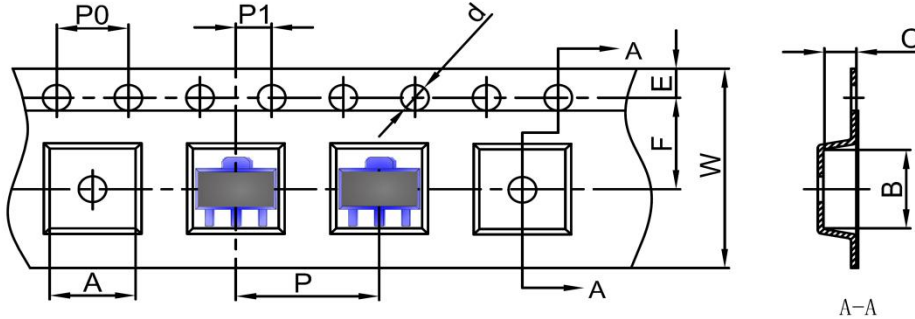
SOT-89 Embossed Carrier Tape



DIMENSIONS ARE IN MILLIMETER										
TYPE	A	B	C	d	E	F	P0	P	P1	W
SOT-89	4.85	4.45	1.85	Ø1.50	1.75	5.50	4.00	8.00	2.00	12.00
TOLERANCE	±0.1	±0.1	±0.1	±0.1	±0.1	±0.1	±0.1	±0.1	±0.1	±0.1

SOT-89 Tape Leader and Trailer

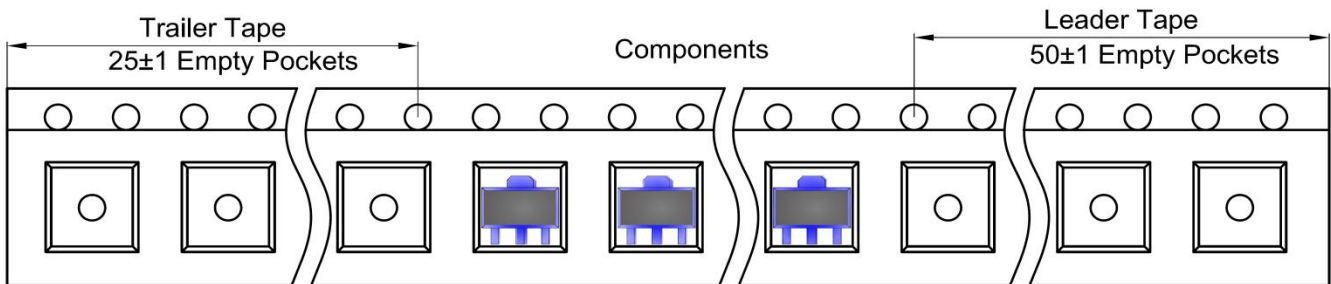

SOT-89 Reel

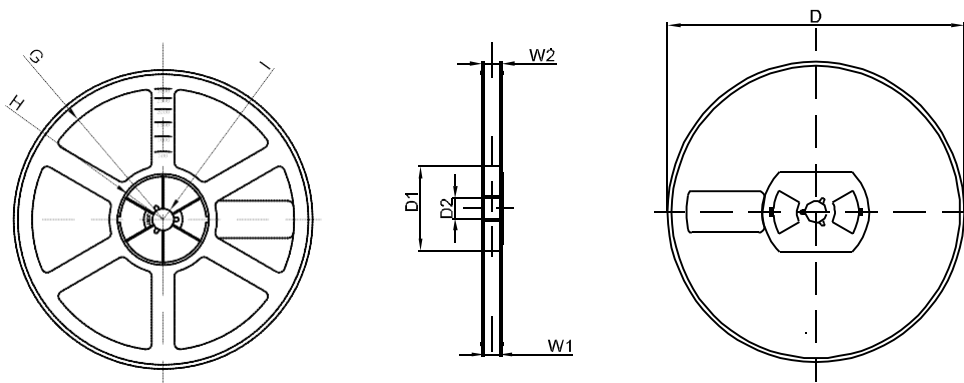

DIMENSIONS ARE IN MILLIMETER								
REEL OPTION	D	D1	D2	G	H	I	W1	W2
7" DIA	Ø178	54.40	13.00	R78	R25.60	R6.50	13.20	16.50
TOLERANCE	±2	±1	±1	±1	±1	±1	±1	±1