

PLL2087NASR - 25° FWHM

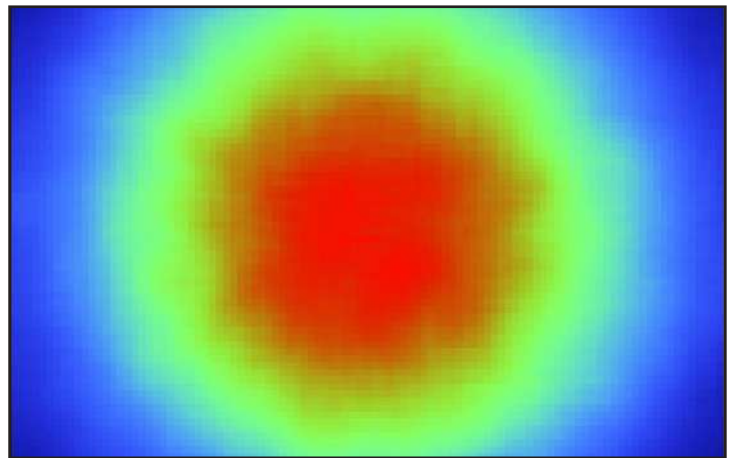
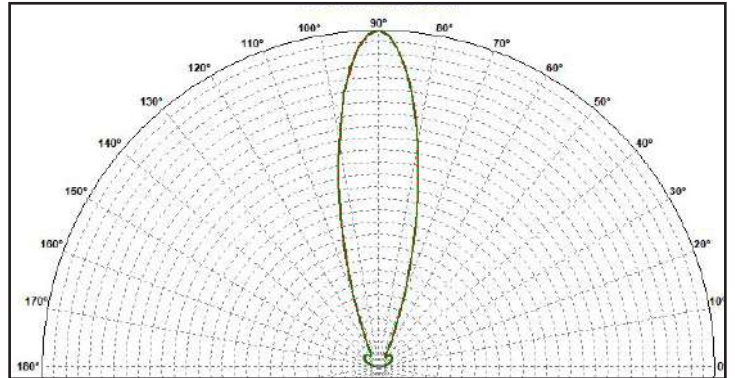

- Material = **SILICONE** for Lens, PC For KEL2056 Fixing Ring
- Full angle at 50% from maximum: ~ 25°
- Full angle at 10% from maximum: ~ 45°
- The light spots here represented refer to tests carried out with CoBs 19mm LES, ~2450lm@LED

Note:-

- Dimensions in inches into brackets
- For missing dimensions see 3D file
- GREY surfaces embossed 25/27 VDI
- WHITE surfaces mirror polished
- RED surfaces available area for gate material
- Gate will be removed by tool
- Sink mark injection will be present
- © - Quality Control Dimensions (QCD)

In date 23/10/2017 modified:

- Removed steps and optics on the upper surface
- GREEN surface embossed 15/17 VDI
- ORANGE surfaces embossed 30/32 VDI

65.99 (2.598)
65.14 (2.565)
75 (2.953) ±0.15
51.25 (2.016)
51.54 (2.029)
51.54 (2.029)
51.25 (2.016)
75 (2.953) ±0.15
4.02 (0.158)
3 (0.118)
64.97 (2.556)
63.05 (2.482)
33.8 (1.331) ±0.10
4.6 (0.181)
2.85 (0.112) ±0.10
0 (0)
0.4 (0.016)
60.34 (2.376)
59 (2.323)
36.24 (1.427)
2 (0.08)
8.04 (0.316)

** Project and Design owned by Khatod OPTOELECTRONIC s. r. l. ** The technical solutions adopted in this design are Khatod intellectual property, they cannot be reproduced and transmitted to third parties without our prior written permission. Unauthorized disclosure of confidential proprietary information will be prosecuted by law.		
DESCRIPTION : TIR LENS	DESIGNER : LM/TAS	PROJECT : PLL 2056 SR KH
CODICE : PLL 2087 NASR	CHECKED : TAS	DATA : 16/10/2017
KHATOD Via Alessandrina, 29 Cusano Milanese MILANO ITALIA WWW.KHATOD.COM	Scale: 1 : 1	23/10/2017
General Tolerances 4/-0.35	HEAD TOLERANCE: NONE	MATERIAL: LSR 7060 J
	SCALE : 1 : 1	SHEET : 1 of 1

KEL2056 - Fixing Ring



KEL2056 - PC CLEAR
STANDARD



KEL2056/01 - PC BLACK
On Request



KEL2056ALU - ALUMINIUM
On Request

KEL2056 Drawing

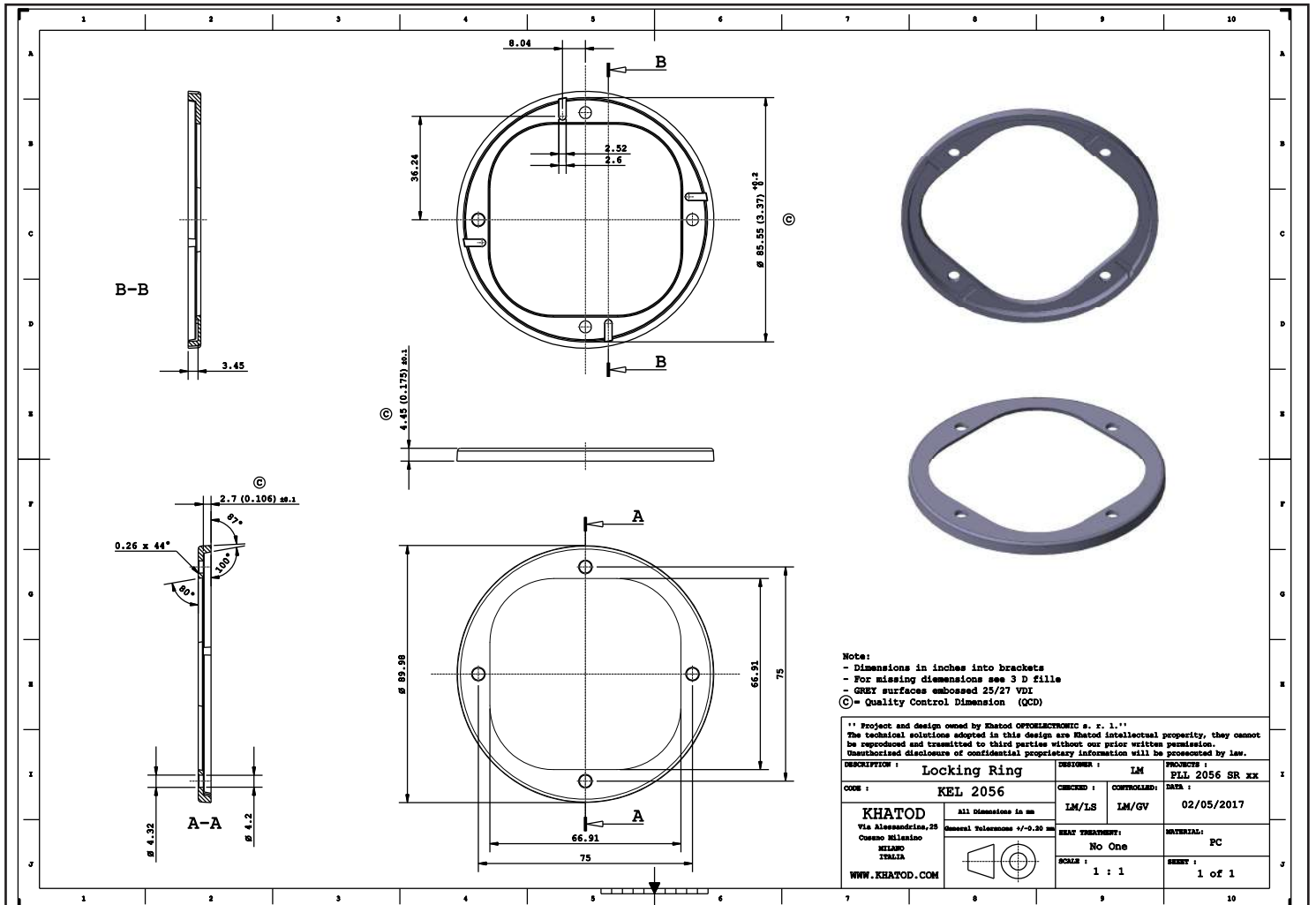

Assembly Specifications

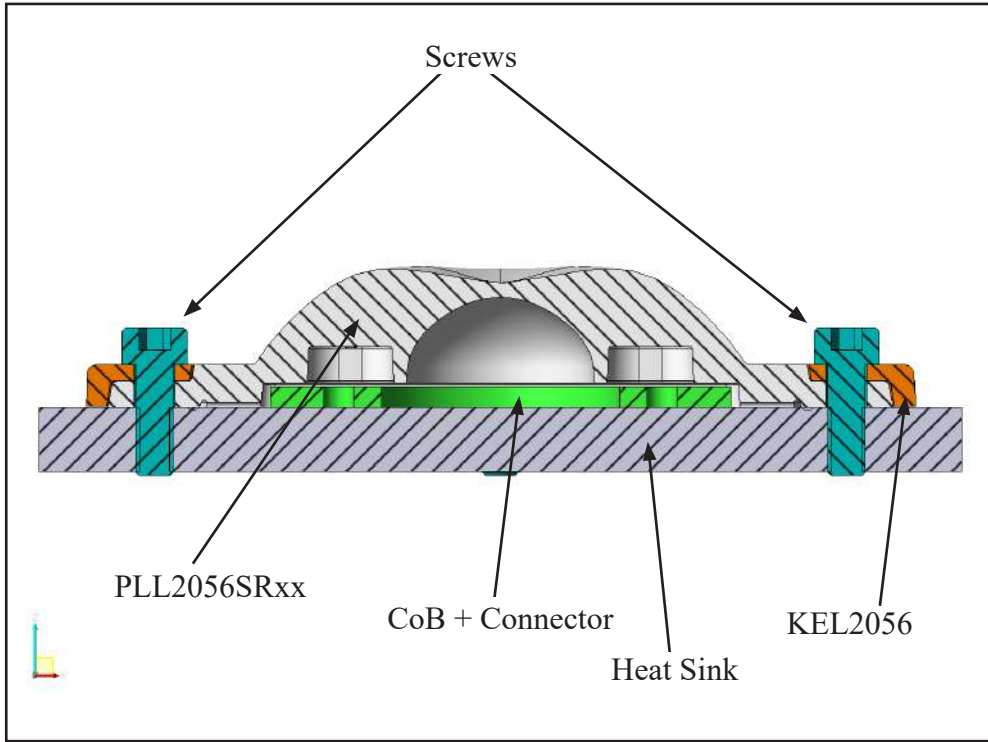

Assembly

- Use TCEI M3/M4 screws
- Use Press Fit
- Maximum recommended tightening torque: 0.5/0.6 Nm

Using Connectors

LED HALTER / OPTIK
LED HOLDER / OPTICS

**BENDER
+ WIRTH**

KHATOD
Optical Solutions for LED Lighting

**SiO3
SiO3 Junior**

Khatod Linse
Khatod lens

[Khatod partnumbers](#)

Hersteller Webseite
Manufacturer website

www.khatod.com

LED Halter B+W
LED Holder B+W

4xx / Typ K1

4xx Typ K1

**New
SiO3 JUNIOR**
Diam. 30mm
COB LEDs with LES from 9mm to 23mm diameter

SiO3
Size: 111mm x 100mm
COB LEDs with LES from 13mm to 53mm diameter

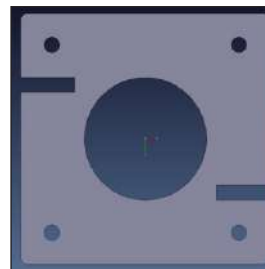

Bender+Wirth
4 xx_k1
Dimensions:
51x51x2,25
LES to 9mm at
30mm

Mögliche Halter / COB Kombinationen / Holder / COB combinations Khatod SiO3

COB Hersteller COB Supplier	COB Typ COB Type	LES LES	Halter Holder	Linse Lens
Bridgelux	H9	9 mm	441 Typ K1	see Khatod website
Bridgelux	V9 HD	9 mm	496 Typ K1	see Khatod website
Bridgelux	V10 / V13	13 mm	455 Typ K1	see Khatod website
Bridgelux	V10 Gen7	10 mm	486 Typ K1	see Khatod website
Bridgelux	V13 Gen7	14 mm	477 Typ K1	see Khatod website
Bridgelux	V15	15 mm	456 Typ K1	see Khatod website
Bridgelux	V18	19 mm	456 Typ K1	see Khatod website
Bridgelux	V18 Gen7	19 mm	462 Typ K1	see Khatod website
Bridgelux	V22 / V22 Gen7	23 mm	431 Typ K1	see Khatod website
Bridgelux	Vesta DTW 9mm	9 mm	490 Typ K1	see Khatod website
Bridgelux	Vesta DTW 13mm / 15mm	16 mm	491 Typ K1	see Khatod website
Bridgelux	Vesta Tunable 9mm	10 mm	489 Typ K1	see Khatod website

Determination of thermal shock resistance degree

Note

The present document is an internal document showing the tests carried out by Khatod in its laboratory. The tests, photos and videos presented in this document are made available for demonstration purposes only. Khatod, with its laboratory, is not a certification body.

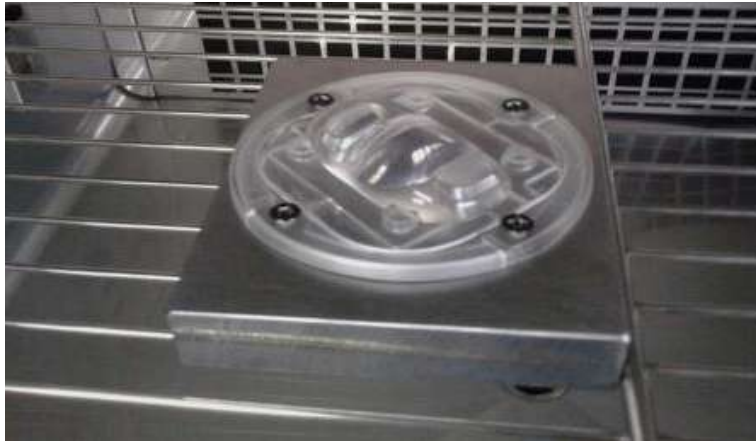

Initial Visual Inspection

Before starting with testing, a visual inspection was performed in order to check the integrity of the part under test.

The part resulted physically intact.

Photo: the part in the climatic chamber.



Temperature set in the climatic chamber

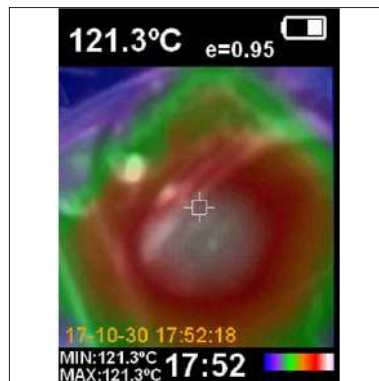

Temperature detected on the part by IR thermal camera



Final Visual Inspection

After testing, a final visual inspection was performed. The result was positive. (view photo)

Photo: the part in the climatic chamber after testing.

Based on the testing result, PLL2056SRxx test specimen proved to overcome the thermal stress test up to 120°C, without any physical deterioration of the material.

Determination of mechanical impact resistance degree (IK tests)

Note

The present document is an internal document showing the tests carried out by Khatod in its laboratory. The tests, photos and videos presented in this document are made available for demonstration purposes only. Khatod, with its laboratory, is not a certification body. If customers need IK accredited certifications, they have to apply to the appointed Certification Bodies, under their sole care and responsibility.

Initial Visual Inspection

- Before starting with testing, a visual inspection was performed in order to check the integrity of the part under test. The part resulted physically intact.

Tests Execution

Tests were carried out on the part under test according to IK10 (20 Joules)
Test parameters are as follows:

- Impact energy: 20 Joules
- Impacting element: 5 Kg
- Distance between impacting element and the part under test: 40 cm
- Number of impacts: 5



1st impact test

2nd impact test

3rd impact test



1st TEST

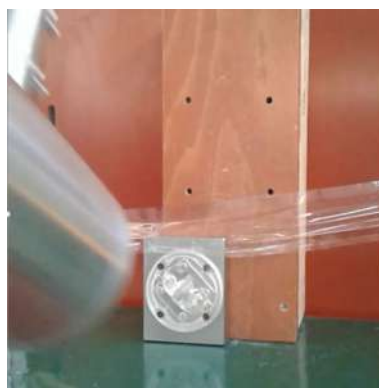

2nd TEST



3rd TEST

Final Visual Inspection

Final Visual Inspection:
At the conclusion of the tests, a final visual inspection has been carried out and the result is positive (See photo 5)



Photo 5

Final Visual Inspection:
After testing, a final visual inspection was performed. The result was positive. (view photo)

IP X5 Test

Note

The present document is an internal document showing the tests carried out by Khatod in its laboratory. The tests, photos and videos presented in this document are made available for demonstration purposes only. Khatod, with its laboratory, is not a certification body.

If customers need IP accredited certifications, they have to apply to the appointed Certification Bodies, under their sole care and responsibility.

Data and Analysis

The sample has been subjected to the water-penetration resistance test as follows:

- Assembly of the components to test :
A moisture indicator paper sheet has been interposed between the lens and the clamping base
- Positioning of the assembled sample under the device of watering with nozzle Ø 6.3 millimeters
- Water flow: 12.5 l/min ± 5%
- Water pressure: 30 kPa @ distance of 3m
- Duration of water spraying test on the wrap surface per m² : 1 min
- Minimum duration of the test: 3 min
- Distance between the nozzle and the wrap surface: 2.5 Meters



assembly



Testing under water jet



Testing under water jet

Conclusion

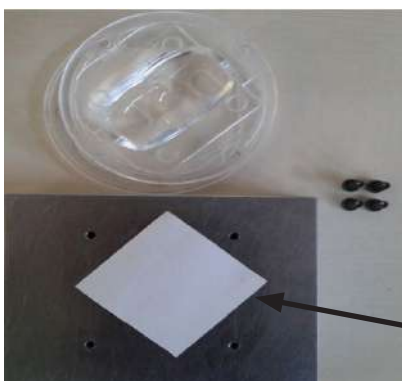

As shown in the photo, the test paper sheet is completely dry after disassembling the system.

Based on the water penetration resistance test, PLL2056SRxx proved to be fit for purpose.

The product has passed the Khatod test.

The test paper sheet is dry

Materials

Material	Top
SILICONE for Lens	-40°...150°C
PC for KEL2056 Fixing Ring	-40°...120°C

Notes:

- Intensity (I) and illuminance (E) data are normalized by 1000 lm
- The optical values shown are the result of optical simulations carried out with ASAP and ZEMAX software systems. The optical simulations are carried out on the basis of the typical values provided in the LED manufacturers' official datasheets. The photometric analysis has been carried out on physical samples. On request, by supplying your PCB, we can provide the measurement photometric file.

Use and Maintenance

- DO NOT HANDLE OR INSTALL LENSES WITHOUT WEARING GLOVES, SKIN OILS MAY DAMAGE LENS OR LIGHT TRANSMISSION;
- CLEAN LENSES WITH MILD SOAP AND WATER AND A SOFT CLOTH;
- DO NOT USE ANY COMMERCIAL CLEANING SOLVENTS ON LENSES.

Disclaimer

Please note that flow lines and weld lines on the external surfaces of the lenses are acceptable if the optical performance of the lens is within the specifications.

Should you require further information, please contact Khatod for advice. All lens testing must be subject to identical conditions as Khatod test condition. Khatod Optoelectronic, Milan, Italy, manufactures lenses for LEDs. Any other use of the lens shall void our liability and warranty. The lenses are an inert component to be used in the manufacture of various products. Our warranty and liability are limited only to the manufacture of the lens. You may not modify, copy, distribute reproduce, license or alter the lens and related materials of Khatod. Khatod does not warrant against damages or defects arising out of the use or misuse of the products; against defects or damage arising from improper installation, or against defects in the product or in its components. No warranty of any kind, expressed or implied, is made regarding the safety of the products. The entire risk as to the quality or performance of the product is with the buyer. In no event shall Khatod be liable for any direct, indirect, punitive, incidental, special, consequential damages, or any damages whatsoever arising out of or connected with the use or misuse of the product. Khatod shall not have any obligation with respect to the product or any part thereof, whether based on contract, tort, strict liability or otherwise. Buyer assumes all risks and liability from use of the product. The laws of Milan, Italy govern this product warranty and liability and you hereby consent to the exclusive jurisdiction and venue of courts in Milan, Italy in all disputes arising out of or relating to the use of this product. Production, marketing, distribution, sale of these products as well as their possible modifications and variations are only exclusive right of Khatod Optoelectronic. No company can perform any of these actions without written permission released by Khatod Optoelectronic. The information contained in this document is proprietary of Khatod Optoelectronic and may change without notice.

REPRODUCTION PROHIBITED.