

GPS+GSM+WIFI Combination Antenna JCE046

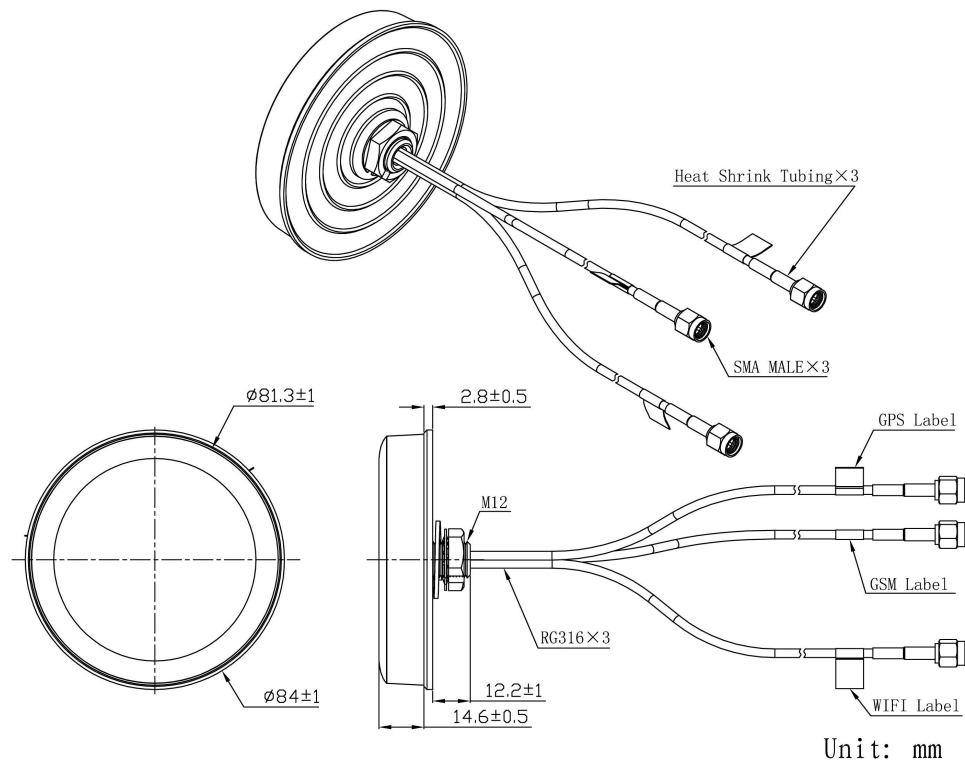

DIMENSIONS



SPECIFICATIONS

Item		Specifications	
GPS Antenna	Dielectric Antenna	Center Frequency	1575.42±3MHz
		Band Width	CF±5MHz
		Polarization	RHCP
		Gain	2dBic (Zenith)
		V.S.W.R	<1.5
		Impedance	50Ω
		Axial Ratio	3dB (max)
	LNA	Gain	28±2dB
		Noise Figure	<1.5dB
		V.S.W.R	<2.0
Supply Voltage		2.2~5V DC	
Current Consumption		5~15mA	
GSM Antenna		Frequency Range	824~960MHz/1710~2170MHz
		V.S.W.R	<2.0
		Polarization	Linear
		Gain	2.0dBi
		Impedance	50Ω
WIFI Antenna		Frequency Range	2400~2483.5MHz
		Band Width	83.5MHz
		Polarization	Linear
		Gain	3dBi
		V.S.W.R	<2.0
		Impedance	50 Ω
Mechanical		Cable	RG174
		Connector	SMA/MCX/FAKRA or others
		Material	ABS
		Mounting Method	Screw
Environmental		Operating Temperature	-40℃~+85℃
		Relative Humidity	Up to 95%

JIAXING JINCHANG ELECTRONIC TECHNOLOGY CO.,LTD

Add: 398#,Zhenye Road, South Street, Jiaxing, Zhejiang, China

Http:// www.jinchanggps.com

E-mail:jcgps@vip.163.com

Tel: 86-0573-83692157/83692605/83958637 Fax:86-0573-83958635

	Ingress Protection	IP65~IP66 (exclude cable outlet)
	Vibration	10 to 55Hz with 1.5mm amplitude 2hours
	Environmentally Friendly	ROHS Compliant

Radiation Pattern

GPS Antenna

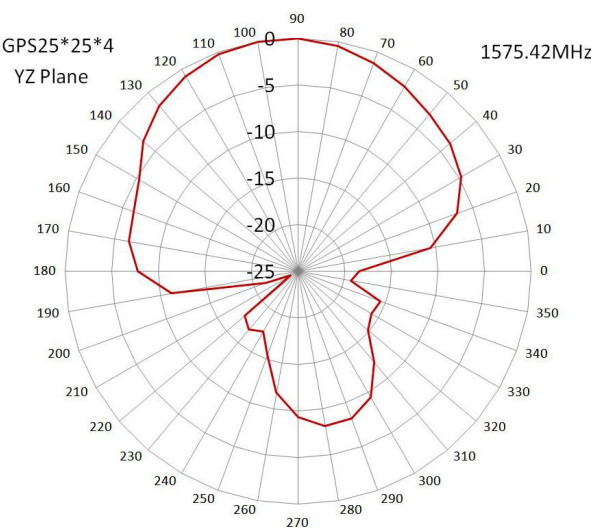
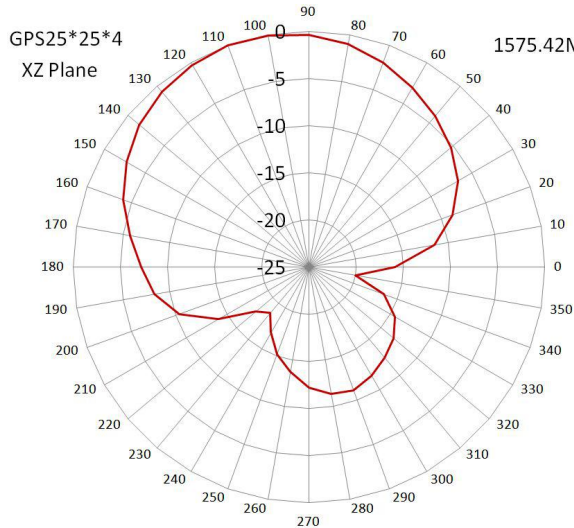
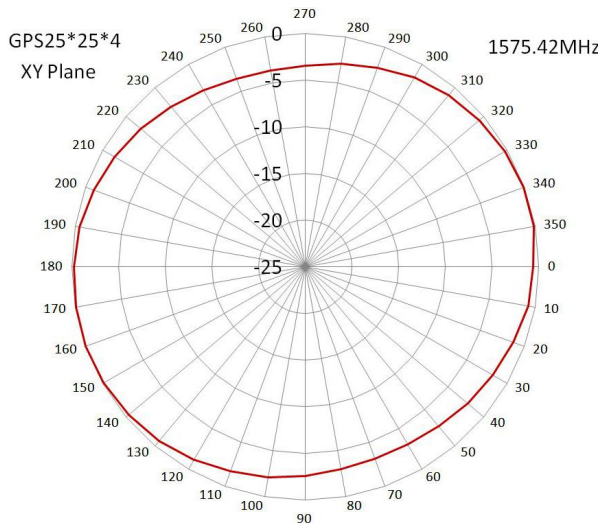

GSM Antenna



Jinchang Electron Global Service

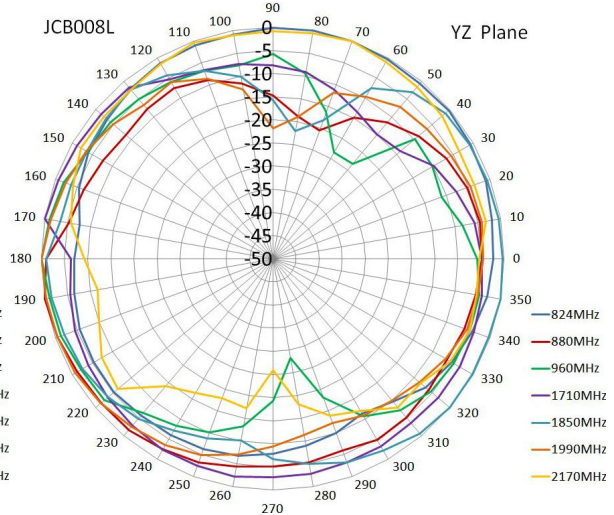
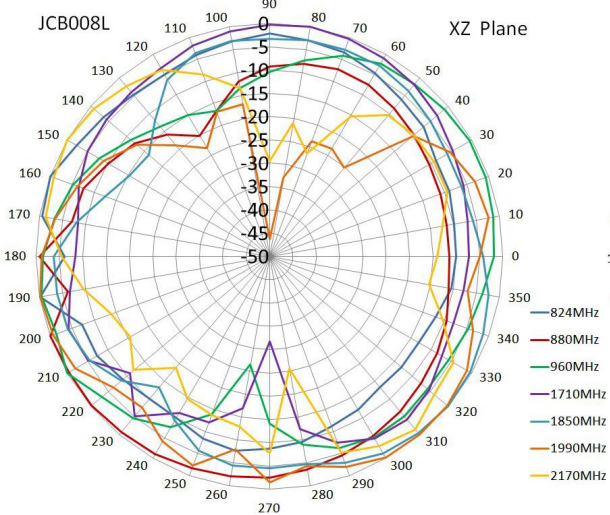
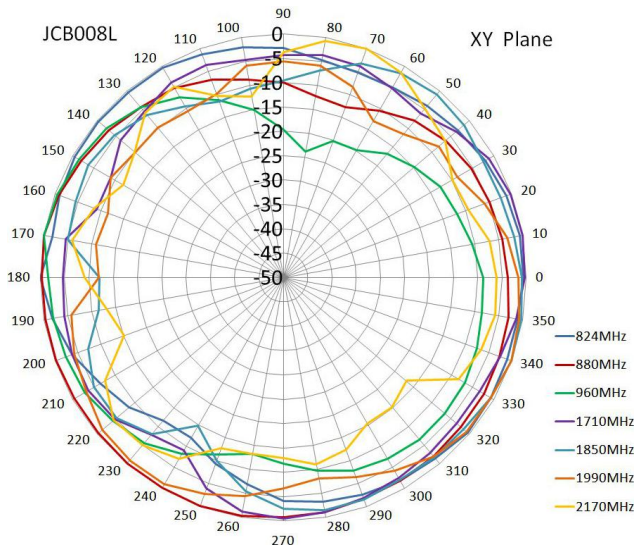

WIFI Antenna

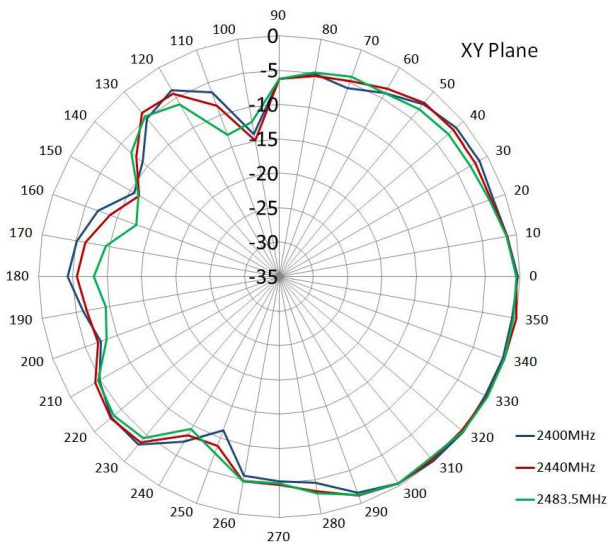

JIAXING JINCHANG ELECTRONIC TECHNOLOGY CO.,LTD

Add: 398#, Zhenye Road, South Street, Jiaxing, Zhejiang, China

Http:// www.jinchanggps.com

E-mail: jcgps@vip.163.com

Tel: 86-0573-83692157/83692605/83958637 Fax: 86-0573-83958635



Jinchang Electron Global Service

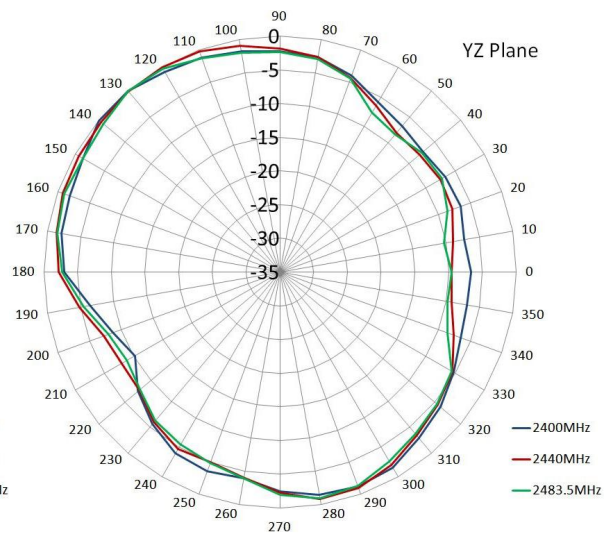
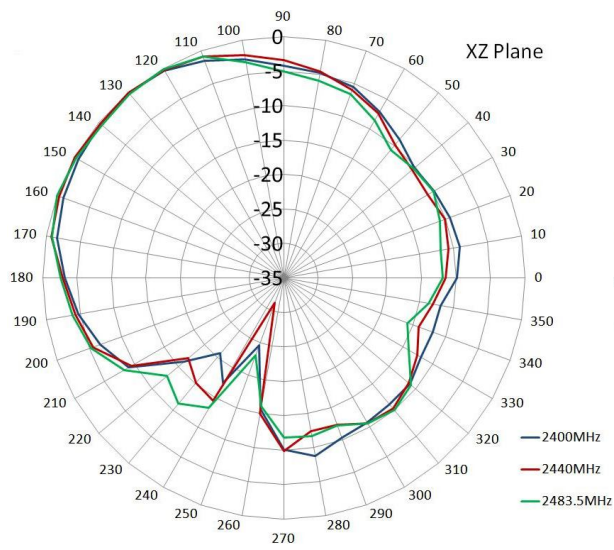

JIAXING JINCHANG ELECTRONIC TECHNOLOGY CO.,LTD

Add: 398#, Zhenye Road, South Street, Jiaxing, Zhejiang, China

Http:// www.jinchanggps.com

E-mail: jcgps@vip.163.com

Tel: 86-0573-83692157/83692605/83958637 Fax: 86-0573-83958635