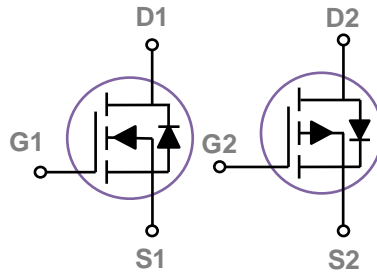
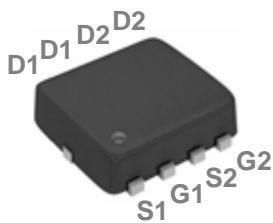


### General Description

These N+P dual Channel enhancement mode power field effect transistors are using trench DMOS technology. This advanced technology has been especially tailored to minimize on-state resistance, provide superior switching performance, and withstand high energy pulse in the avalanche and commutation mode. These devices are well suited for high efficiency fast switching applications.

BVDSS	RDSON	ID
30V	20mΩ	12A
-30V	50mΩ	-8A

### PPAK3X3 Dual Pin Configuration



### Features

- Fast switching
- Green Device Available
- Suit for 4.5V Gate Drive Applications

### Applications

- DC Fan
- Motor Drive Applications
- Networking
- Half / Full Bridge Topology

### Absolute Maximum Ratings $T_c=25^\circ\text{C}$ unless otherwise noted

Symbol	Parameter	Rating		Units
$V_{DS}$	Drain-Source Voltage	30	-30	V
$V_{GS}$	Gate-Source Voltage	$\pm 20$	$\pm 20$	V
$I_D$	Drain Current – Continuous ( $T_c=25^\circ\text{C}$ )	12	-8	A
	Drain Current – Continuous ( $T_c=100^\circ\text{C}$ )	7.2	-4.8	A
$I_{DM}$	Drain Current – Pulsed <sup>1</sup>	48	-32	A
EAS	Single Pulse Avalanche Energy <sup>2,6</sup>	14	5	mJ
IAS	Single Pulse Avalanche Current <sup>2</sup>	17	10	A
$P_D$	Power Dissipation ( $T_c=25^\circ\text{C}$ )	20		W
	Power Dissipation – Derate above $25^\circ\text{C}$	0.16		W/ $^\circ\text{C}$
$T_{STG}$	Storage Temperature Range	-55 to 150		$^\circ\text{C}$
$T_J$	Operating Junction Temperature Range	-55 to 150		$^\circ\text{C}$

### Thermal Characteristics

Symbol	Parameter	Typ.	Max.	Unit
$R_{\theta JA}$	Thermal Resistance Junction to ambient	---	62.5	$^\circ\text{C}/\text{W}$
$R_{\theta JC}$	Thermal Resistance Junction to Case	---	6.4	$^\circ\text{C}/\text{W}$

**N-CH Electrical Characteristics (T<sub>J</sub>=25 °C, unless otherwise noted)**
**Off Characteristics**

Symbol	Parameter	Conditions	Min.	Typ.	Max.	Unit
BV <sub>DSS</sub>	Drain-Source Breakdown Voltage	V <sub>GS</sub> =0V , I <sub>D</sub> =250uA	30	---	---	V
I <sub>DSS</sub>	Drain-Source Leakage Current	V <sub>DS</sub> =30V , V <sub>GS</sub> =0V , T <sub>J</sub> =25°C	---	---	1	uA
		V <sub>DS</sub> =24V , V <sub>GS</sub> =0V , T <sub>J</sub> =125°C	---	---	10	uA
I <sub>GSS</sub>	Gate-Source Leakage Current	V <sub>GS</sub> =±20V , V <sub>DS</sub> =0V	---	---	±100	nA

**On Characteristics**

R <sub>DS(ON)</sub>	Static Drain-Source On-Resistance	V <sub>GS</sub> =10V , I <sub>D</sub> =10A	---	15	20	mΩ
		V <sub>GS</sub> =4.5V , I <sub>D</sub> =6A	---	21	30	mΩ
V <sub>GS(th)</sub>	Gate Threshold Voltage	V <sub>GS</sub> =V <sub>DS</sub> , I <sub>D</sub> =250uA	1.2	1.5	2.5	V
ΔV <sub>GS(th)</sub>	V <sub>GS(th)</sub> Temperature Coefficient		---	-4	---	mV/°C
g <sub>fs</sub>	Forward Transconductance	V <sub>DS</sub> =5V , I <sub>D</sub> =6A	---	13	---	S

**Dynamic and switching Characteristics**

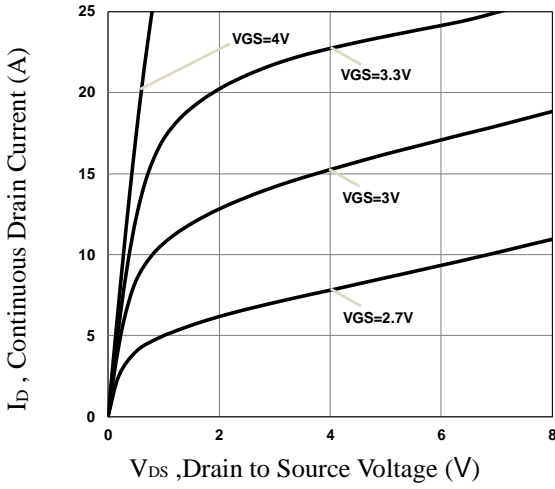
Q <sub>g</sub>	Total Gate Charge <sup>3, 4</sup>	V <sub>DS</sub> =15V , V <sub>GS</sub> =4.5V , I <sub>D</sub> =8A	---	4.1	6	nC
Q <sub>gs</sub>	Gate-Source Charge <sup>3, 4</sup>		---	1	1.4	
Q <sub>gd</sub>	Gate-Drain Charge <sup>3, 4</sup>		---	2.1	4	
T <sub>d(on)</sub>	Turn-On Delay Time <sup>3, 4</sup>	V <sub>DD</sub> =15V , V <sub>GS</sub> =10V , R <sub>G</sub> =6Ω I <sub>D</sub> =1A	---	2.8	5	ns
T <sub>r</sub>	Rise Time <sup>3, 4</sup>		---	7.2	14	
T <sub>d(off)</sub>	Turn-Off Delay Time <sup>3, 4</sup>		---	15.8	30	
T <sub>f</sub>	Fall Time <sup>3, 4</sup>		---	4.6	9	
C <sub>iss</sub>	Input Capacitance	V <sub>DS</sub> =25V , V <sub>GS</sub> =0V , F=1MHz	---	345	500	pF
C <sub>oss</sub>	Output Capacitance		---	55	80	
C <sub>rss</sub>	Reverse Transfer Capacitance		---	32	55	
R <sub>g</sub>	Gate resistance	V <sub>GS</sub> =0V , V <sub>DS</sub> =0V , F=1MHz	---	3.2	6.4	Ω

**Drain-Source Diode Characteristics and Maximum Ratings**

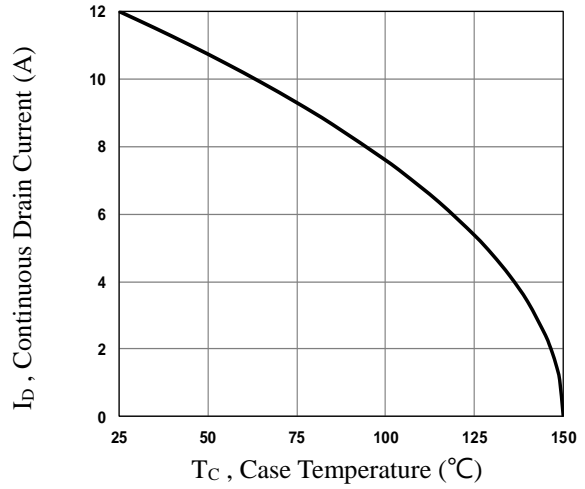
Symbol	Parameter	Conditions	Min.	Typ.	Max.	Unit
I <sub>S</sub>	Continuous Source Current	V <sub>G</sub> =V <sub>D</sub> =0V , Force Current	---	---	12	A
I <sub>SM</sub>	Pulsed Source Current		---	---	24	A
V <sub>SD</sub>	Diode Forward Voltage	V <sub>GS</sub> =0V , I <sub>S</sub> =1A , T <sub>J</sub> =25°C	---	---	1	V
t <sub>rr</sub>	Reverse Recovery Time	V <sub>R</sub> =30V , I <sub>S</sub> =10A	---	110	---	ns
Q <sub>rr</sub>	Reverse Recovery Charge	di/dt=100A/μs , T <sub>J</sub> =25°C	---	145	---	nC

Note :

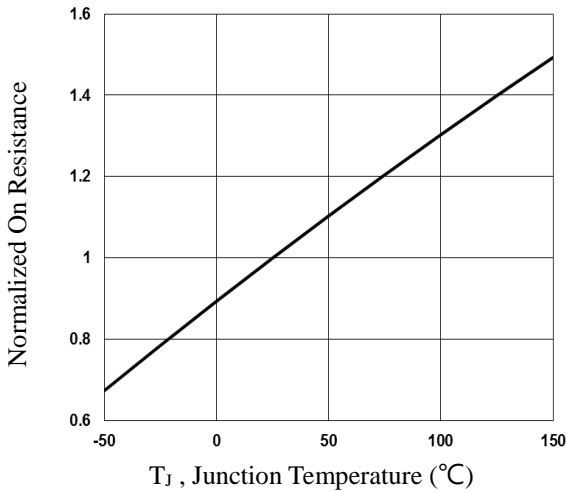
1. Repetitive Rating : Pulsed width limited by maximum junction temperature.
2. V<sub>DD</sub>=25V, V<sub>GS</sub>=10V, L=0.1mH, I<sub>AS</sub>=17A., R<sub>G</sub>=25Ω, Starting T<sub>J</sub>=25°C.
3. The data tested by pulsed , pulse width ≤ 300us , duty cycle ≤ 2%.
4. Essentially independent of operating temperature.



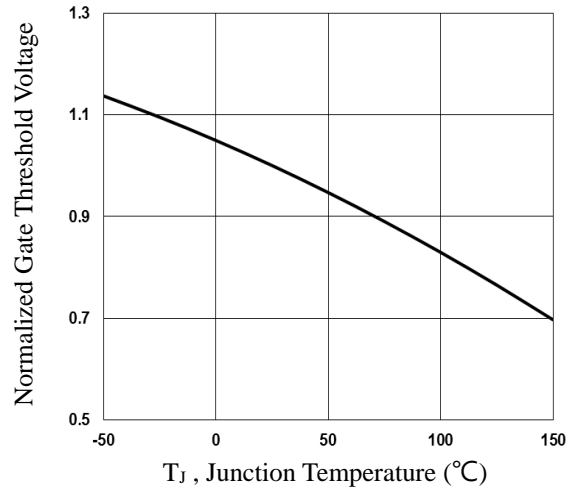
**Fig.1 Typical Output Characteristics**



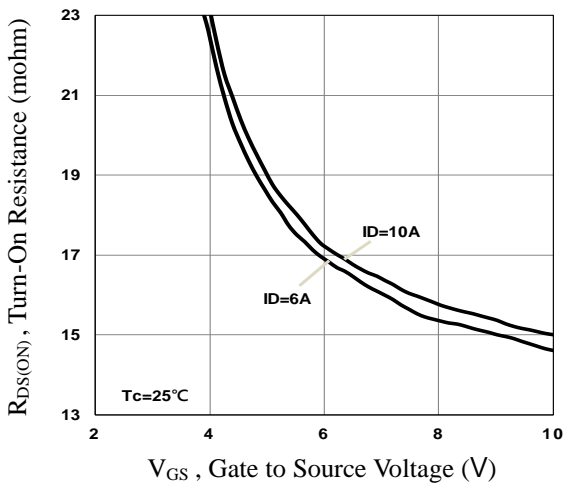
**Fig.2 Continuous Drain Current vs. T<sub>c</sub>**



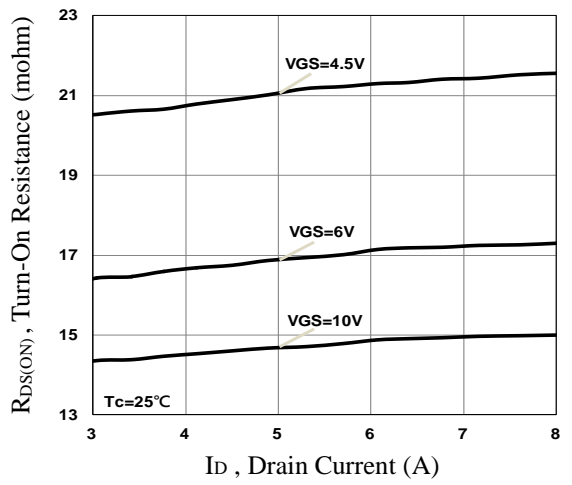
**Fig.3 Normalized R<sub>DS(on)</sub> vs. T<sub>j</sub>**



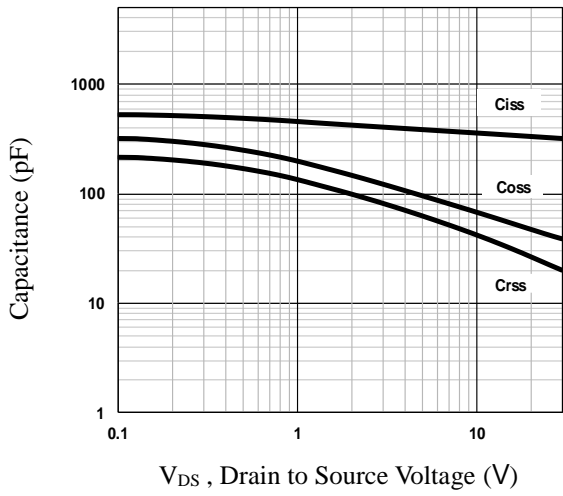
**Fig.4 Normalized V<sub>th</sub> vs. T<sub>j</sub>**



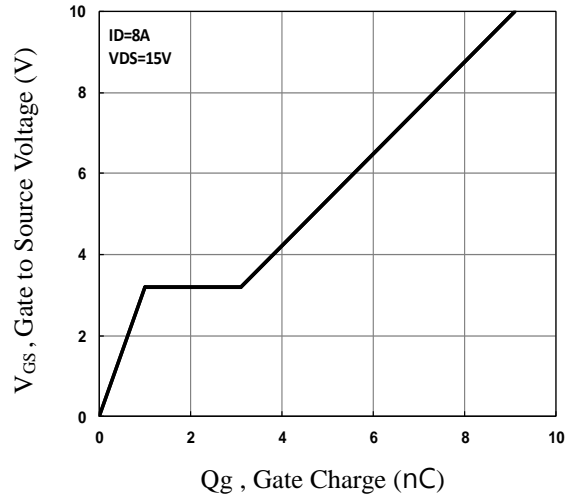
**Fig.5 Turn-On Resistance vs. V<sub>GS</sub>**



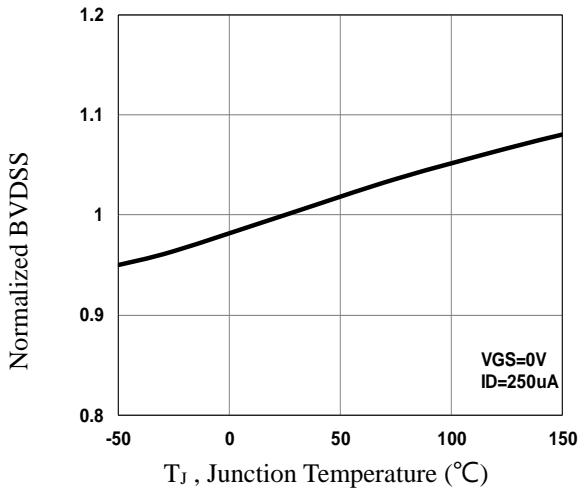
**Fig.6 Turn-On Resistance vs. I<sub>D</sub>**



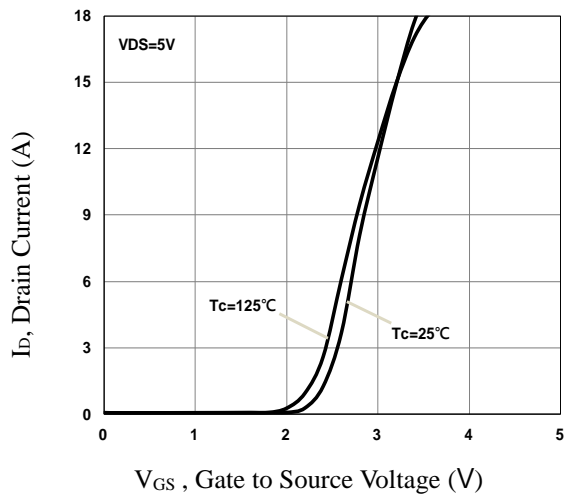
**Fig.7 Capacitance Characteristics**



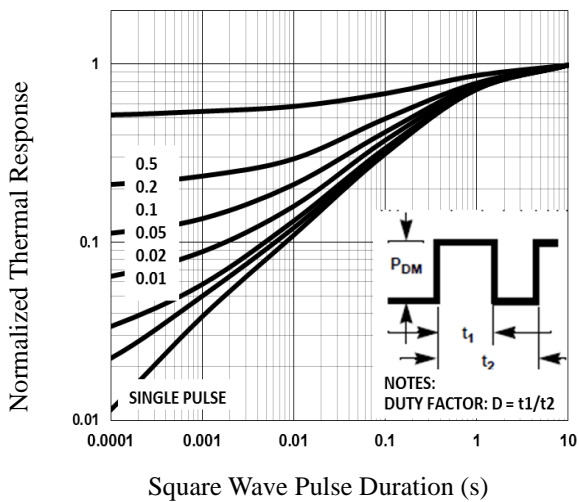
**Fig.8 Gate Charge Characteristics**



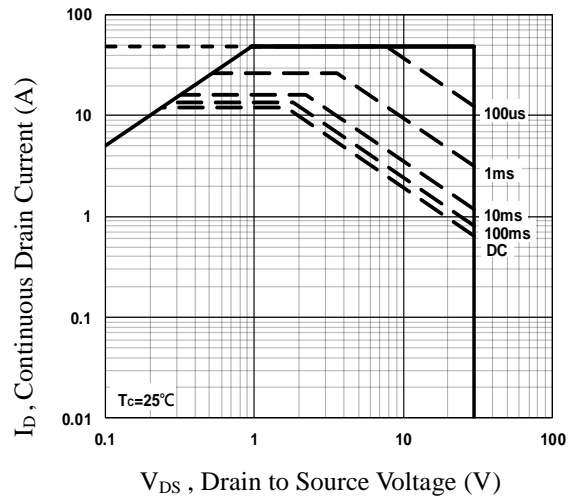
**Fig.9 Normalized BVDS vs.  $T_J$**



**Fig.10 Transfer Characteristics**



**Fig.11 Normalized Transient Impedance**



**Fig.12 Maximum Safe Operation Area**

**P-CH Electrical Characteristics (T<sub>J</sub>=25 °C, unless otherwise noted)**
**Off Characteristics**

Symbol	Parameter	Conditions	Min.	Typ.	Max.	Unit
BV <sub>DSS</sub>	Drain-Source Breakdown Voltage	V <sub>GS</sub> =0V , I <sub>D</sub> =-250uA	-30	---	---	V
ΔBV <sub>DSS</sub> /ΔT <sub>J</sub>	BV <sub>DSS</sub> Temperature Coefficient	Reference to 25°C , I <sub>D</sub> =-1mA	---	-0.03	---	V/°C
I <sub>DSS</sub>	Drain-Source Leakage Current	V <sub>DS</sub> =-30V , V <sub>GS</sub> =0V , T <sub>J</sub> =25°C	---	---	-1	uA
		V <sub>DS</sub> =-24V , V <sub>GS</sub> =0V , T <sub>J</sub> =125°C	---	---	-10	uA
I <sub>GSS</sub>	Gate-Source Leakage Current	V <sub>GS</sub> =±20V , V <sub>DS</sub> =0V	---	---	±100	nA

**On Characteristics**

R <sub>DS(ON)</sub>	Static Drain-Source On-Resistance	V <sub>GS</sub> =-10V , I <sub>D</sub> =-5A	---	40	50	mΩ
		V <sub>GS</sub> =-4.5V , I <sub>D</sub> =-3A	---	60	75	mΩ
V <sub>GS(th)</sub>	Gate Threshold Voltage	V <sub>GS</sub> =V <sub>DS</sub> , I <sub>D</sub> =-250uA	-1.2	-1.6	-2.5	V
ΔV <sub>GS(th)</sub>	V <sub>GS(th)</sub> Temperature Coefficient		---	4	---	mV/°C
g <sub>fs</sub>	Forward Transconductance	V <sub>DS</sub> =-10V , I <sub>D</sub> =-3A	---	3.5	---	S

**Dynamic and switching Characteristics**

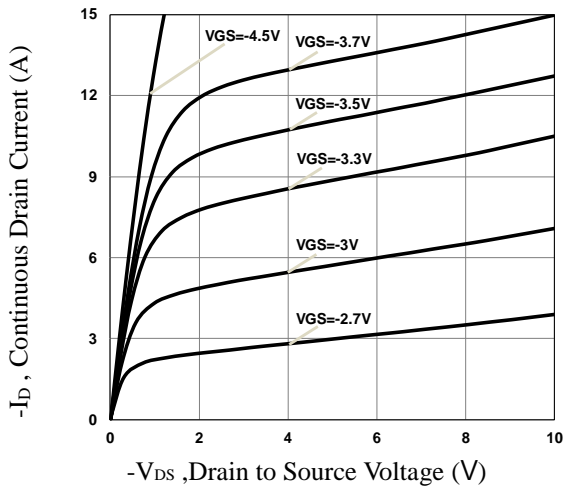
Q <sub>g</sub>	Total Gate Charge <sup>7,8</sup>	V <sub>DS</sub> =-15V , V <sub>GS</sub> =-4.5V , I <sub>D</sub> =-3A	---	5.1	7	nC
Q <sub>gs</sub>	Gate-Source Charge <sup>7,8</sup>		---	2	3	
Q <sub>gd</sub>	Gate-Drain Charge <sup>7,8</sup>		---	2.2	4	
T <sub>d(on)</sub>	Turn-On Delay Time <sup>7,8</sup>	V <sub>DD</sub> =-15V , V <sub>GS</sub> =-10V , R <sub>G</sub> =6Ω I <sub>D</sub> =-1A	---	3.4	6	ns
T <sub>r</sub>	Rise Time <sup>7,8</sup>		---	10.8	21	
T <sub>d(off)</sub>	Turn-Off Delay Time <sup>7,8</sup>		---	26.9	51	
T <sub>f</sub>	Fall Time <sup>7,8</sup>		---	6.9	13	
C <sub>iss</sub>	Input Capacitance	V <sub>DS</sub> =-15V , V <sub>GS</sub> =0V , F=1MHz	---	560	810	pF
C <sub>oss</sub>	Output Capacitance		---	55	80	
C <sub>rss</sub>	Reverse Transfer Capacitance		---	40	60	

**Drain-Source Diode Characteristics and Maximum Ratings**

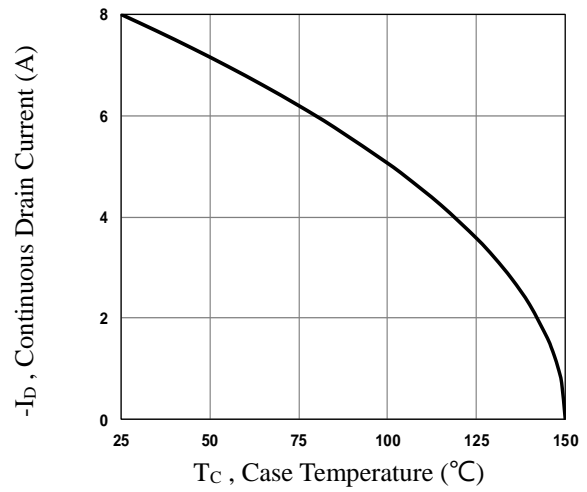
Symbol	Parameter	Conditions	Min.	Typ.	Max.	Unit
I <sub>S</sub>	Continuous Source Current	V <sub>G</sub> =V <sub>D</sub> =0V , Force Current	---	---	-8	A
I <sub>SM</sub>	Pulsed Source Current		---	---	-16	A
V <sub>SD</sub>	Diode Forward Voltage	V <sub>GS</sub> =0V , I <sub>S</sub> =-1A , T <sub>J</sub> =25°C	---	---	-1	V
t <sub>rr</sub>	Reverse Recovery Time	V <sub>R</sub> =-30V , I <sub>S</sub> =-3A	---	155	---	ns
Q <sub>rr</sub>	Reverse Recovery Charge	di/dt=100A/μs , T <sub>J</sub> =25°C	---	250	---	nC

Note :

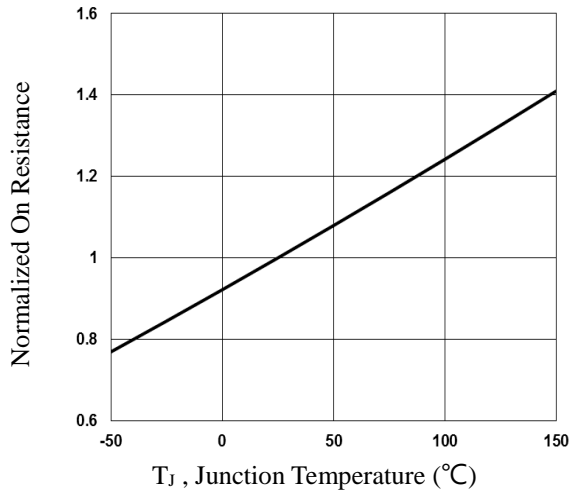
5. Repetitive Rating : Pulsed width limited by maximum junction temperature.
6. V<sub>DD</sub>=-25V, V<sub>GS</sub>=-10V, L=0.1mH, I<sub>AS</sub>=-10A., R<sub>G</sub>=25Ω, Starting T<sub>J</sub>=25°C
7. The data tested by pulsed , pulse width ≤ 300us , duty cycle ≤ 2%.
8. Essentially independent of operating temperature.



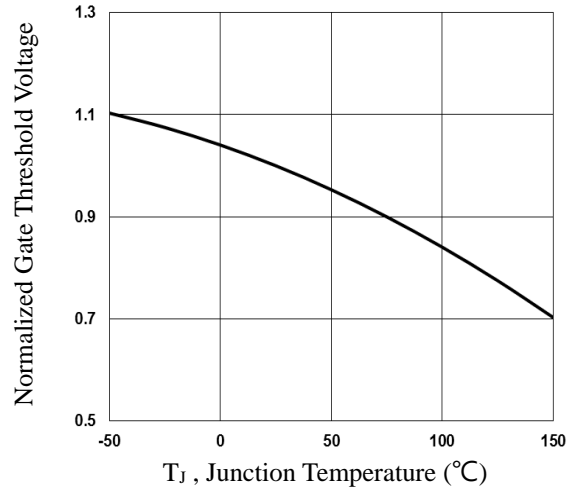
**Fig.13 Typical Output Characteristics**



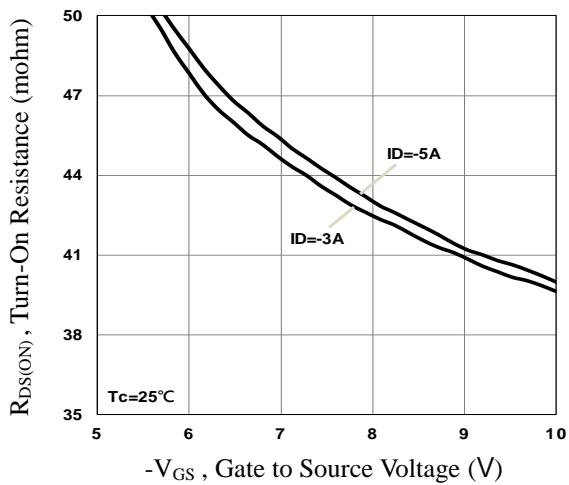
**Fig.14 Continuous Drain Current vs. TC**



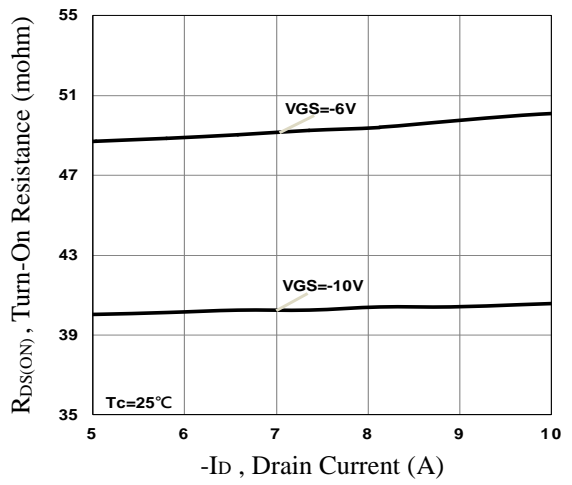
**Fig.15 Normalized RDS(on) vs. TJ**



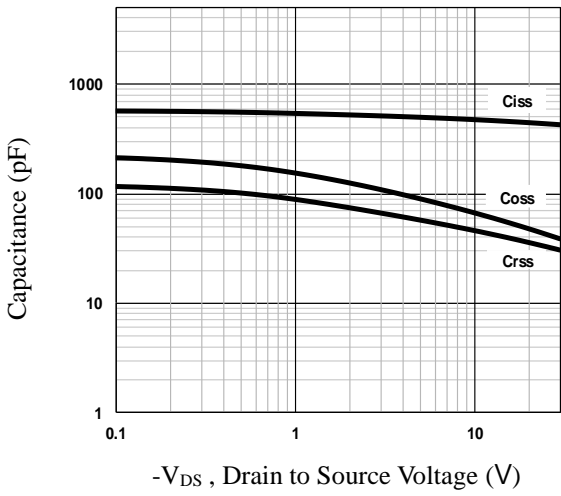
**Fig.16 Normalized Vth vs. TJ**



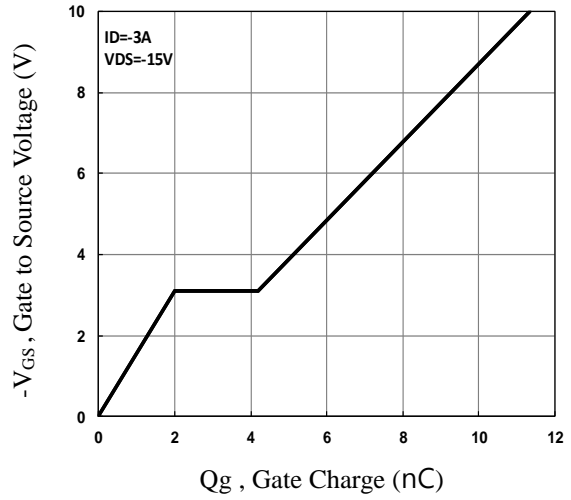
**Fig.17 Turn-On Resistance vs. VGS**



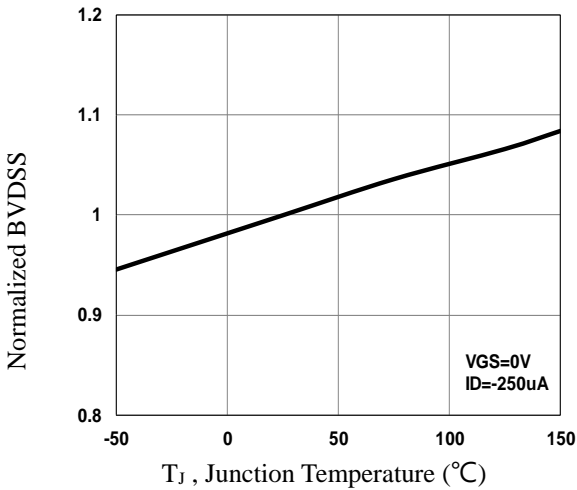
**Fig.18 Turn-On Resistance vs. ID**



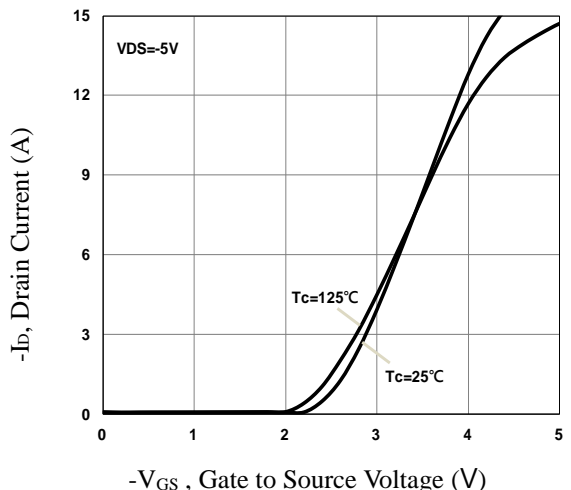
**Fig.19 Capacitance Characteristics**



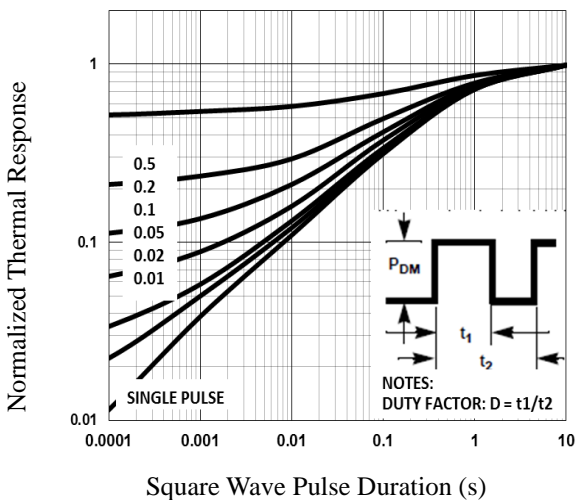
**Fig.20 Gate Charge Characteristics**



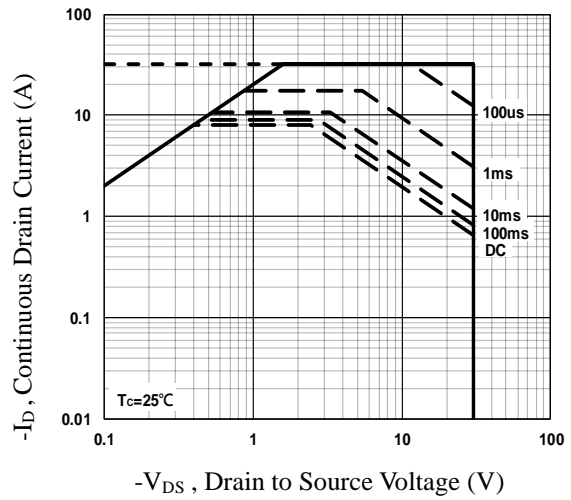
**Fig.21 Normalized BVDSS vs.  $T_J$**



**Fig.22 Transfer Characteristics**

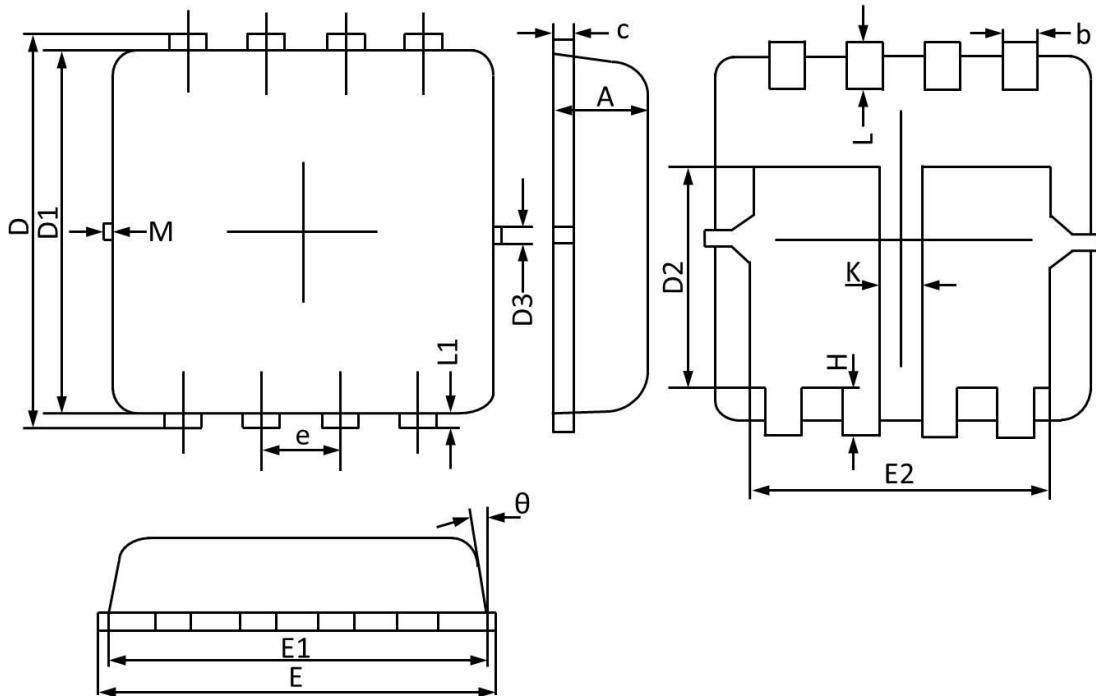


**Fig.23 Normalized Transient Impedance**



**Fig.24 Maximum Safe Operation Area**

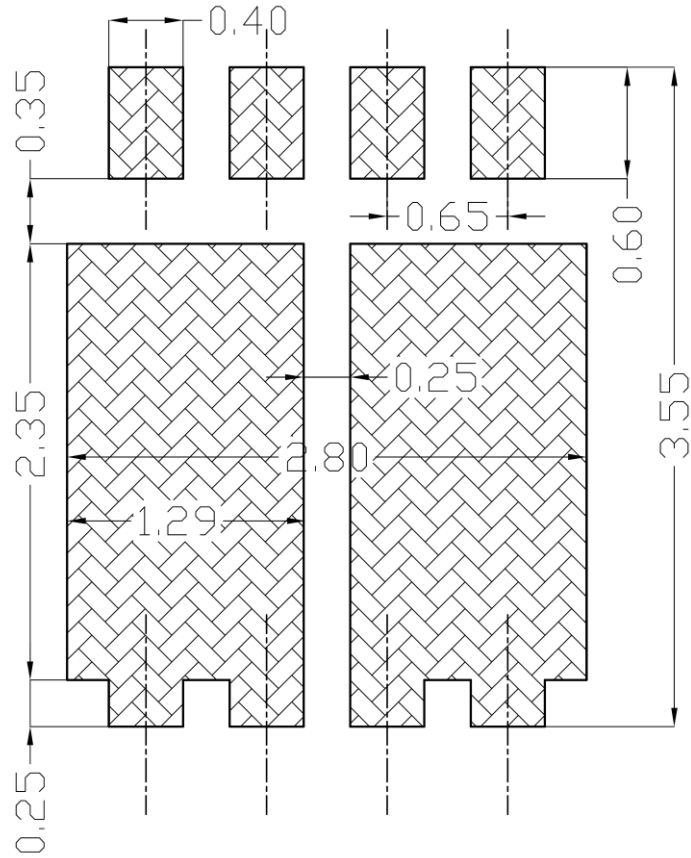
PPAK3x3 Dual PACKAGE INFORMATION



Symbol	Dimensions In Millimeters		Dimensions In Inches	
	Min	Max	Min	Max
A	0.670	0.880	0.026	0.035
b	0.250	0.350	0.010	0.014
c	0.100	0.250	0.004	0.010
D	3.150	3.550	0.124	0.140
D1	3.000	3.300	0.118	0.130
D2	1.500	2.000	0.059	0.079
D3	0.130	0.200	0.005	0.008
E	3.100	3.500	0.122	0.138
E1	3.000	3.200	0.118	0.126
E2	2.350	2.600	0.093	0.102
e	0.650 BSC		0.026 BSC	
H	0.300	0.500	0.012	0.020
L	0.300	0.500	0.012	0.020
L1	0.130 REF		0.005 REF	
K	0.300 REF		0.012 REF	
θ	0°	12°	0°	12°
M	0.150 REF		0.006 REF	



### PPAK3X3 Dual RECOMMENDED LAND PATTERN



unit : mm