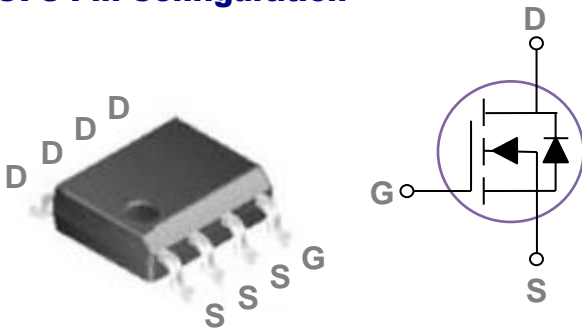


### General Description

These N-Channel enhancement mode power field effect transistors are using trench DMOS technology. This advanced technology has been especially tailored to minimize on-state resistance, provide superior switching performance, and withstand high energy pulse in the avalanche and commutation mode. These devices are well suited for high efficiency fast switching applications.

### SOP8 Pin Configuration



|       |       |     |
|-------|-------|-----|
| BVDSS | RDSON | ID  |
| 65V   | 7mΩ   | 10A |

### Features

- 65V, 10A,  $R_{DS(ON)} = 7m\Omega @ V_{GS} = 10V$
- Improved  $dv/dt$  capability
- Fast switching
- 100% EAS Guaranteed
- Green Device Available

### Applications

- Networking
- Load Switch
- LED applications
- Quick Charger

### Absolute Maximum Ratings $T_c=25^\circ C$ unless otherwise noted

| Symbol    | Parameter                                       | Rating     | Units         |
|-----------|---|------------|---------------|
| $V_{DS}$  | Drain-Source Voltage                            | 65         | V             |
| $V_{GS}$  | Gate-Source Voltage                             | $\pm 20$   | V             |
| $I_D$     | Drain Current – Continuous ( $T_A=25^\circ C$ ) | 10         | A             |
|           | Drain Current – Continuous ( $T_A=70^\circ C$ ) | 8          | A             |
| $I_{DM}$  | Drain Current – Pulsed <sup>1</sup>             | 40         | A             |
| EAS       | Single Pulse Avalanche Energy <sup>2</sup>      | 88         | mJ            |
| IAS       | Single Pulse Avalanche Current <sup>2</sup>     | 42         | A             |
| $P_D$     | Power Dissipation ( $T_A = 25^\circ C$ )        | 2          | W             |
|           | Power Dissipation – Derate above $25^\circ C$   | 0.016      | W/ $^\circ C$ |
| $T_{STG}$ | Storage Temperature Range                       | -55 to 150 | $^\circ C$    |
| $T_J$     | Operating Junction Temperature Range            | -55 to 150 | $^\circ C$    |

### Thermal Characteristics

| Symbol          | Parameter                              | Typ. | Max. | Unit         |
|-----------------|--|------|------|--------------|
| $R_{\theta JA}$ | Thermal Resistance Junction to ambient | ---  | 62.5 | $^\circ C/W$ |

**Electrical Characteristics (T<sub>J</sub>=25 °C, unless otherwise noted)**
**Off Characteristics**

| Symbol            | Parameter                      | Conditions  | Min. | Typ. | Max. | Unit |
|-------------------|--------------------------------|---|------|------|------|------|
| BV <sub>DSS</sub> | Drain-Source Breakdown Voltage | V <sub>GS</sub> =0V, I <sub>D</sub> =250μA                      | 65   | ---  | ---  | V    |
| I <sub>DSS</sub>  | Drain-Source Leakage Current   | V <sub>DS</sub> =60V, V <sub>GS</sub> =0V, T <sub>J</sub> =25°C | ---  | ---  | 1    | μA   |
|                   |                                | V <sub>DS</sub> =48V, V <sub>GS</sub> =0V, T <sub>J</sub> =85°C | ---  | ---  | 10   | μA   |
| I <sub>GSS</sub>  | Gate-Source Leakage Current    | V <sub>GS</sub> =±20V, V <sub>DS</sub> =0V                      | ---  | ---  | ±100 | nA   |

**On Characteristics**

|                     |  |  |     |     |     |    |
|---------------------|--|--|-----|-----|-----|----|
| R <sub>DS(ON)</sub> | Static Drain-Source On-Resistance <sup>3</sup> | V <sub>GS</sub> =10V, I <sub>D</sub> =8A                 | --- | 5.9 | 7   | mΩ |
|                     |  | V <sub>GS</sub> =4.5V, I <sub>D</sub> =6A                | --- | 8.6 | 11  | mΩ |
| V <sub>GS(th)</sub> | Gate Threshold Voltage                         | V <sub>GS</sub> =V <sub>DS</sub> , I <sub>D</sub> =250μA | 1.2 | 1.6 | 2.5 | V  |
| g <sub>fs</sub>     | Forward Transconductance                       | V <sub>DS</sub> =10V, I <sub>D</sub> =3A                 | --- | 9   | --- | S  |

**Dynamic and switching Characteristics**

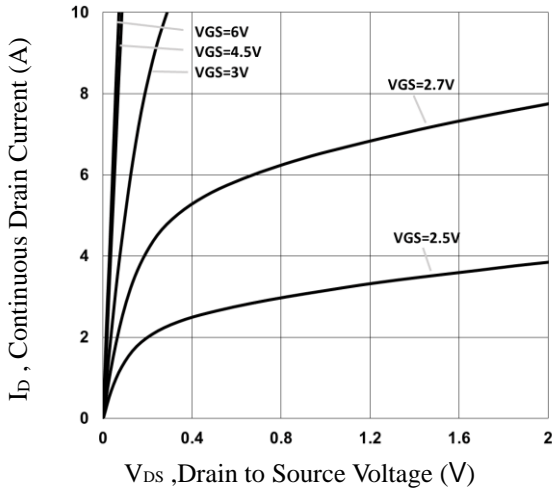
|                     |                                     |  |     |      |      |    |
|---------------------|-------------------------------------|--|-----|------|------|----|
| Q <sub>g</sub>      | Total Gate Charge <sup>3, 4</sup>   | V <sub>DS</sub> =30V, V <sub>GS</sub> =10V, I <sub>D</sub> =5A                       | --- | 24   | 36   | nC |
| Q <sub>gs</sub>     | Gate-Source Charge <sup>3, 4</sup>  |  | --- | 1.9  | 3    |    |
| Q <sub>gd</sub>     | Gate-Drain Charge <sup>3, 4</sup>   |  | --- | 5    | 7.5  |    |
| T <sub>d(on)</sub>  | Turn-On Delay Time <sup>3, 4</sup>  | V <sub>DD</sub> =30V, V <sub>GS</sub> =10V, R <sub>G</sub> =6Ω<br>I <sub>D</sub> =5A | --- | 10   | 15   | ns |
| T <sub>r</sub>      | Rise Time <sup>3, 4</sup>           |  | --- | 23   | 35   |    |
| T <sub>d(off)</sub> | Turn-Off Delay Time <sup>3, 4</sup> |  | --- | 27   | 41   |    |
| T <sub>f</sub>      | Fall Time <sup>3, 4</sup>           |  | --- | 12   | 18   |    |
| C <sub>iss</sub>    | Input Capacitance                   | V <sub>DS</sub> =30V, V <sub>GS</sub> =0V, F=1MHz                                    | --- | 1080 | 1620 | pF |
| C <sub>oss</sub>    | Output Capacitance                  |  | --- | 430  | 645  |    |
| C <sub>rss</sub>    | Reverse Transfer Capacitance        |  | --- | 30   | 45   |    |
| R <sub>g</sub>      | Gate resistance                     | V <sub>GS</sub> =0V, V <sub>DS</sub> =0V, F=1MHz                                     | --- | 1    | ---  | Ω  |

**Drain-Source Diode Characteristics and Maximum Ratings**

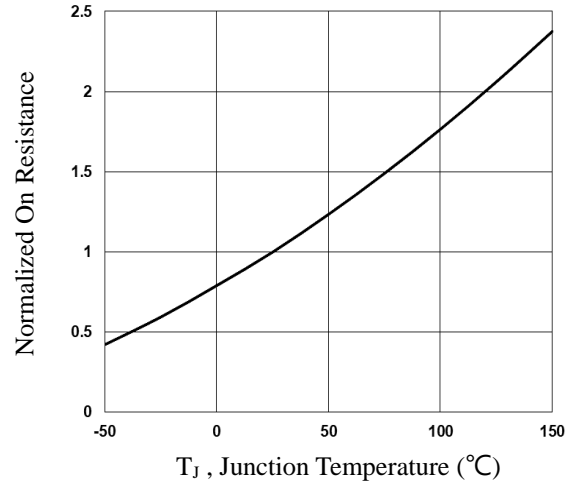
| Symbol          | Parameter                 | Conditions  | Min. | Typ. | Max. | Unit |
|-----------------|---------------------------|---|------|------|------|------|
| I <sub>S</sub>  | Continuous Source Current | V <sub>G</sub> =V <sub>D</sub> =0V, Force Current             | ---  | ---  | 10   | A    |
| I <sub>SM</sub> | Pulsed Source Current     |   | ---  | ---  | 20   | A    |
| V <sub>SD</sub> | Diode Forward Voltage     | V <sub>GS</sub> =0V, I <sub>S</sub> =1A, T <sub>J</sub> =25°C | ---  | ---  | 1    | V    |
| t <sub>rr</sub> | Reverse Recovery Time     | V <sub>R</sub> =50V, I <sub>S</sub> =10A                      | ---  | 40   | ---  | ns   |
| Q <sub>rr</sub> | Reverse Recovery Charge   | di/dt=100A/μs, T <sub>J</sub> =25°C                           | ---  | 40   | ---  | nC   |

Note :

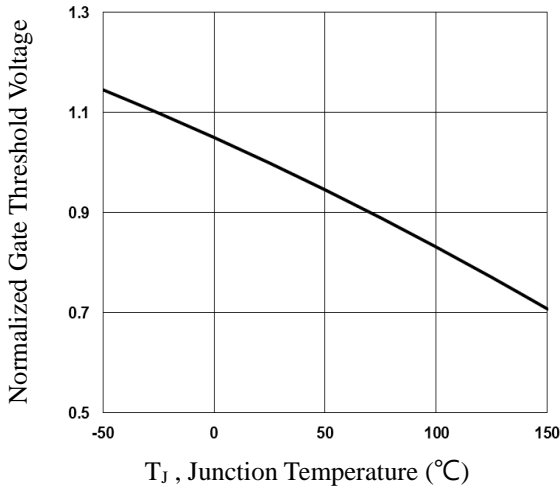
1. Repetitive Rating : Pulsed width limited by maximum junction temperature.
2. V<sub>DD</sub>=25V, V<sub>GS</sub>=10V, L=0.1mH, I<sub>AS</sub>=42A., R<sub>G</sub>=25Ω, Starting T<sub>J</sub>=25°C.
3. The data tested by pulsed, pulse width ≤ 300us, duty cycle ≤ 2%.
4. Essentially independent of operating temperature.



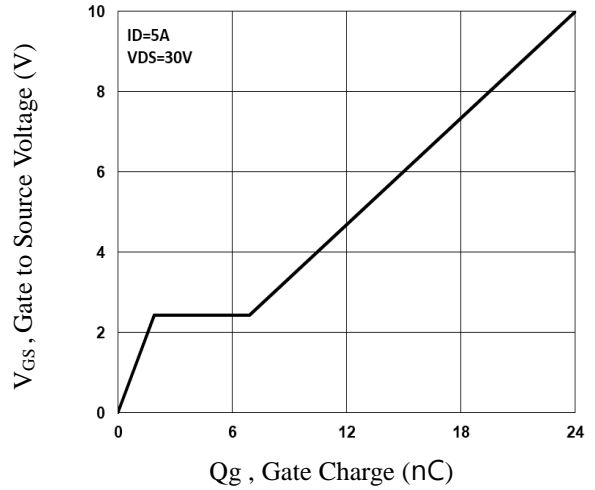
**Fig.1 Typical Output Characteristics**



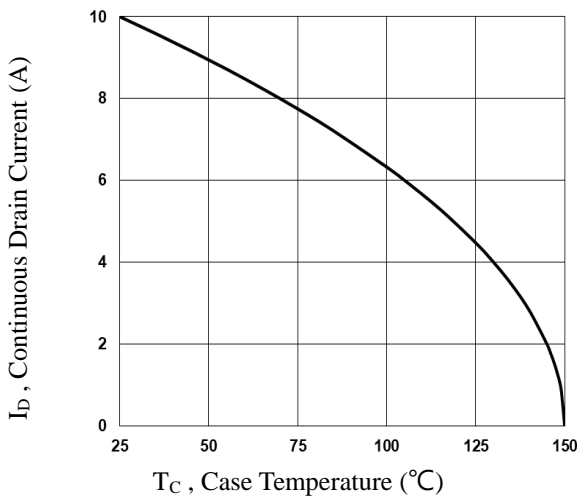
**Fig.2 Normalized  $R_{DS(on)}$  vs.  $T_J$**



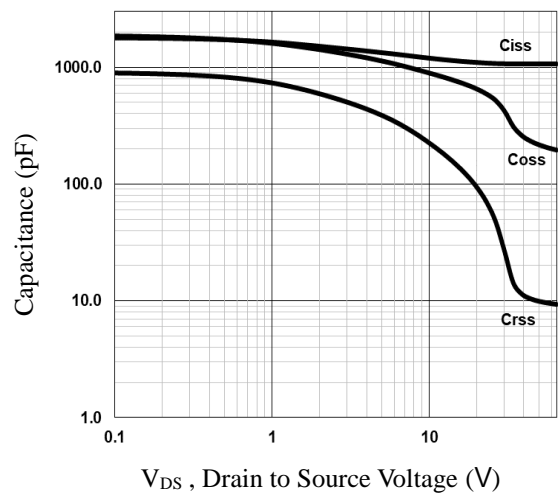
**Fig.3 Normalized  $V_{th}$  vs.  $T_J$**



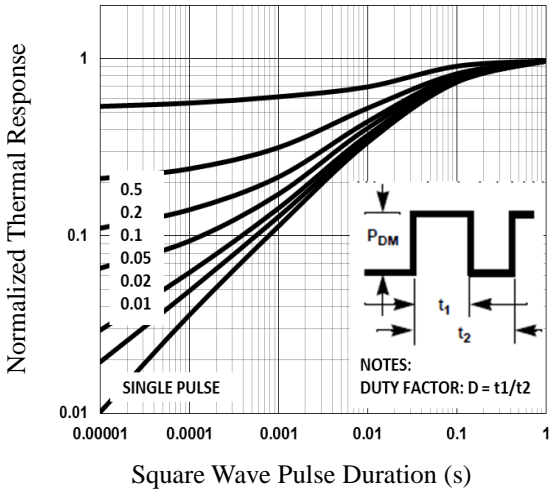
**Fig.4 Gate Charge Waveform**



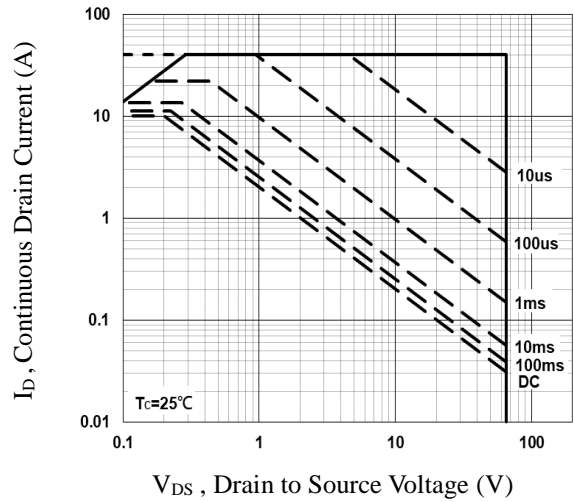
**Fig.5 Continuous Drain Current vs.  $T_C$**



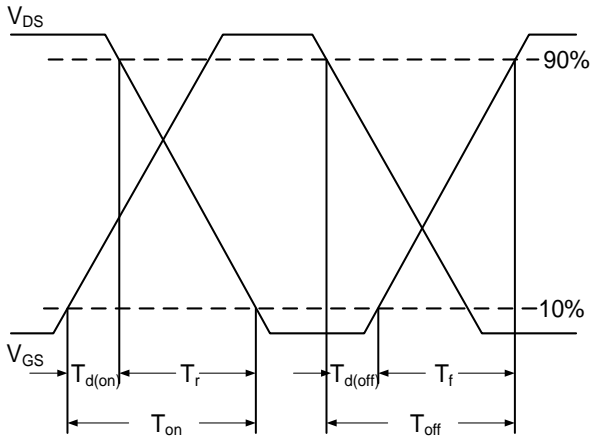
**Fig.6 Capacitance Characteristics**



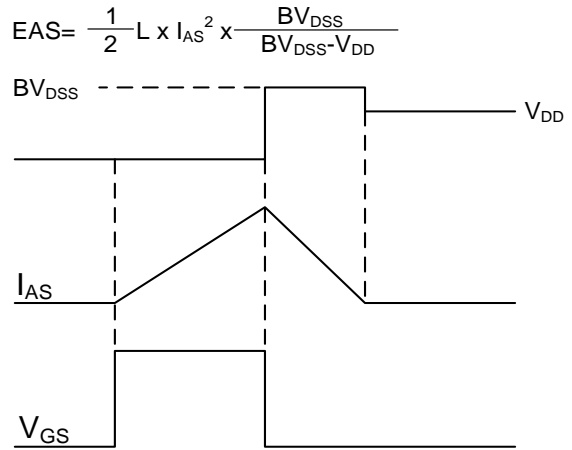
**Fig.7 Normalized Transient Impedance**



**Fig.8 Maximum Safe Operation Area**

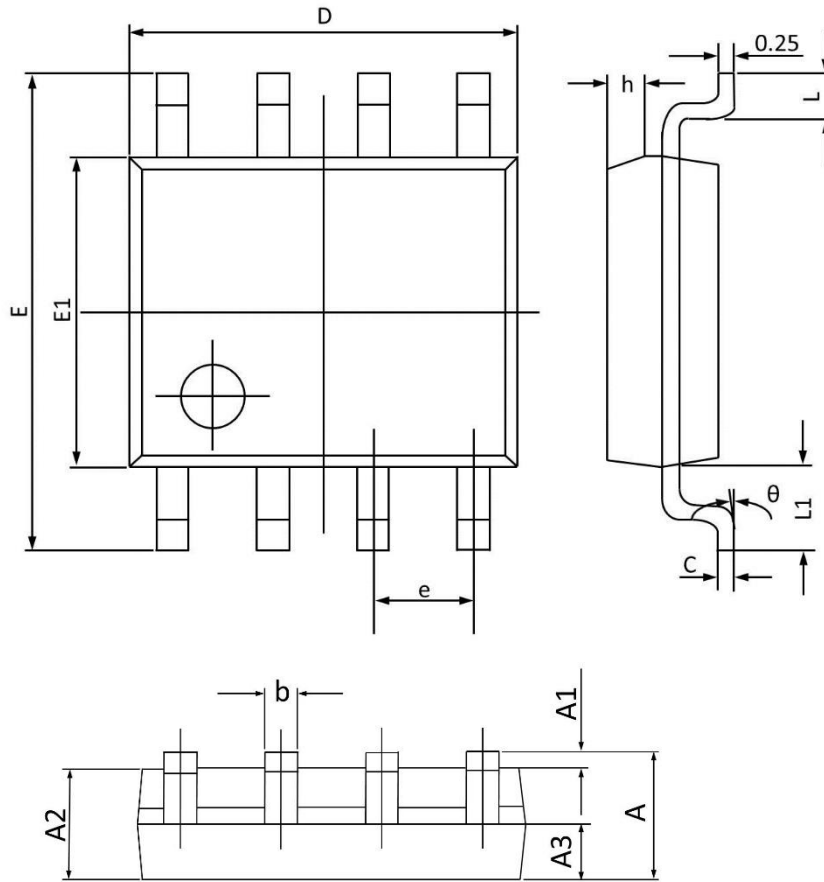


**Fig.9 Switching Time Waveform**



**Fig.10 EAS Waveform**

## SOP8 PACKAGE INFORMATION



| Symbol   | Dimensions In Millimeters |       | Dimensions In Inches |       |
|----------|---------------------------|-------|----------------------|-------|
|          | Min                       | Max   | Min                  | Max   |
| A        | 1.350                     | 1.800 | 0.053                | 0.069 |
| A1       | 0.050                     | 0.250 | 0.002                | 0.010 |
| A2       | 1.250                     | 1.650 | 0.049                | 0.065 |
| A3       | 0.500                     | 0.700 | 0.020                | 0.028 |
| b        | 0.300                     | 0.510 | 0.012                | 0.020 |
| c        | 0.150                     | 0.260 | 0.006                | 0.010 |
| D        | 4.700                     | 5.100 | 0.185                | 0.201 |
| E        | 5.800                     | 6.200 | 0.228                | 0.244 |
| E1       | 3.700                     | 4.100 | 0.146                | 0.161 |
| e        | 1.270(BSC)                |       | 0.050(BSC)           |       |
| h        | 0.250                     | 0.500 | 0.010                | 0.020 |
| L        | 0.400                     | 1.000 | 0.016                | 0.039 |
| L1       | 1.050(BSC)                |       | 0.041(BSC)           |       |
| $\theta$ | 0°                        | 8°    | 0°                   | 8°    |