

General Description

These N+P dual Channel enhancement mode power field effect transistors are using trench DMOS technology. This advanced technology has been especially tailored to minimize on-state resistance, provide superior switching performance, and withstand high energy pulse in the avalanche and commutation mode. These devices are well suited for high efficiency fast switching applications.

SOP8 Pin Configuration

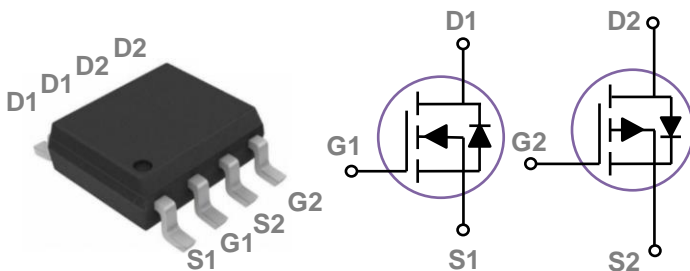

BVDSS	RDSON	ID
60V	29mΩ	6A
-60V	70mΩ	-4.5A

Features

- Fast switching
- Green Device Available
- Suit for 4.5V Gate Drive Applications

Applications

- DC Fan
- Motor Drive Applications
- Networking
- Half / Full Bridge Topology

Absolute Maximum Ratings $T_c=25^\circ\text{C}$ unless otherwise noted

Symbol	Parameter	Rating		Units
V_{DS}	Drain-Source Voltage	60	-60	V
V_{GS}	Gate-Source Voltage	± 20	± 20	V
I_D	Drain Current – Continuous ($T_A=25^\circ\text{C}$)	6	-4.5	A
	Drain Current – Continuous ($T_A=70^\circ\text{C}$)	4.8	-3.6	A
I_{DM}	Drain Current – Pulsed ¹	24	-18	A
P_D	Power Dissipation ($T_A=25^\circ\text{C}$)	2		W
	Power Dissipation – Derate above 25°C	0.016		W/ $^\circ\text{C}$
T_{STG}	Storage Temperature Range	-55 to 150		$^\circ\text{C}$
T_J	Operating Junction Temperature Range	-55 to 150		$^\circ\text{C}$

Thermal Characteristics

Symbol	Parameter	Typ.	Max.	Unit
$R_{\theta JA}$	Thermal Resistance Junction to ambient	---	62.5	$^\circ\text{C}/\text{W}$

N-CH Electrical Characteristics (T_J=25 °C, unless otherwise)
Off Characteristics

Symbol	Parameter	Conditions	Min.	Typ.	Max.	Unit
BV _{DSS}	Drain-Source Breakdown Voltage	V _{GS} =0V, I _D =250uA	60	---	---	V
I _{DSS}	Drain-Source Leakage Current	V _{DS} =60V, V _{GS} =0V, T _J =25°C	---	---	1	uA
		V _{DS} =48V, V _{GS} =0V, T _J =125°C	---	---	10	uA
I _{GSS}	Gate-Source Leakage Current	V _{GS} =±20V, V _{DS} =0V	---	---	±100	nA

On Characteristics

R _{DS(ON)}	Static Drain-Source On-Resistance	V _{GS} =10V, I _D =3A	---	24	29	mΩ
		V _{GS} =4.5V, I _D =2A	---	29	38	mΩ
V _{GS(th)}	Gate Threshold Voltage	V _{GS} =V _{DS} , I _D =250uA	1.2	1.6	2.5	V
g _{fs}	Forward Transconductance	V _{DS} =10V, I _D =2A	---	5	---	S

Dynamic and switching Characteristics

Q _g	Total Gate Charge ^{2, 3}	V _{DS} =30V, V _{GS} =10V, I _D =3A	---	11	17	nC
Q _{gs}	Gate-Source Charge ^{2, 3}		---	1.5	3	
Q _{gd}	Gate-Drain Charge ^{2, 3}		---	3	4.5	
T _{d(on)}	Turn-On Delay Time ^{2, 3}	V _{DD} =30V, V _{GS} =10V, R _G =6Ω I _D =3A	---	6	10	ns
T _r	Rise Time ^{2, 3}		---	7	15	
T _{d(off)}	Turn-Off Delay Time ^{2, 3}		---	46	70	
T _f	Fall Time ^{2, 3}		---	14	20	
C _{iss}	Input Capacitance	V _{DS} =30V, V _{GS} =0V, F=1MHz	---	800	1200	pF
C _{oss}	Output Capacitance		---	60	90	
C _{rss}	Reverse Transfer Capacitance		---	40	60	
R _g	Gate resistance	V _{GS} =0V, V _{DS} =0V, F=1MHz	---	2.8	---	Ω

Drain-Source Diode Characteristics and Maximum Ratings

Symbol	Parameter	Conditions	Min.	Typ.	Max.	Unit
I _S	Continuous Source Current	V _G =V _D =0V, Force Current	---	---	6	A
I _{SM}	Pulsed Source Current		---	---	12	A
V _{SD}	Diode Forward Voltage	V _{GS} =0V, I _S =1A, T _J =25°C	---	---	1	V
T _{rr}	Reverse Recovery Time	V _R =50V, I _S =2A	---	30	---	ns
Q _{rr}	Reverse Recovery Charge	di/dt=100A/μs, T _J =25°C	---	15	---	nC

Note :

1. Repetitive Rating : Pulsed width limited by maximum junction temperature.
2. The data tested by pulsed, pulse width ≤ 300us, duty cycle ≤ 2%.
3. Essentially independent of operating temperature.

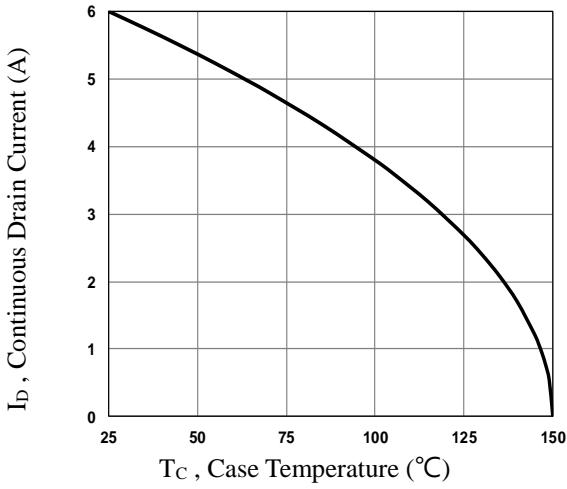

Fig.1 Continuous Drain Current vs. T_c

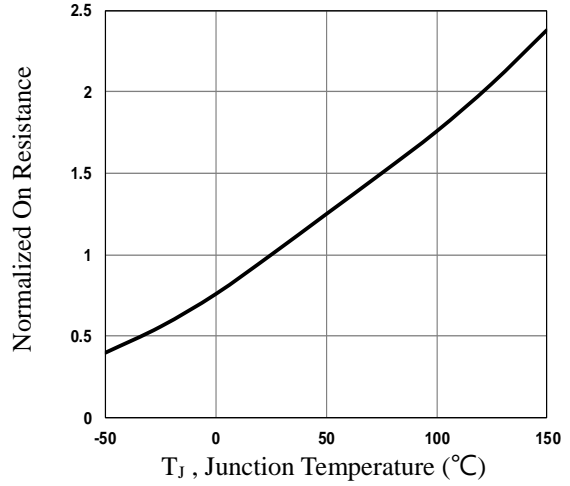

Fig.2 Normalized $R_{DS(on)}$ vs. T_j

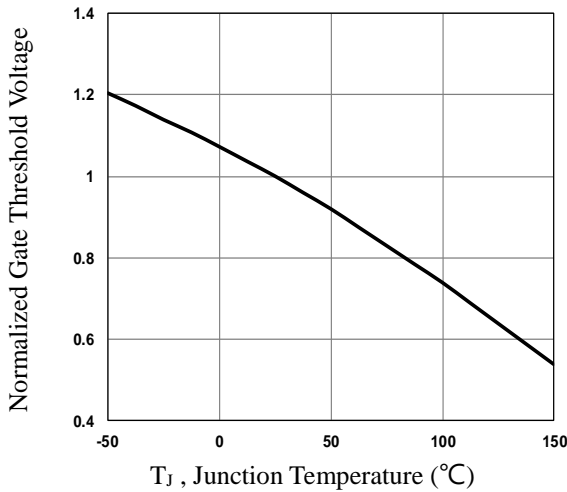

Fig.3 Normalized V_{th} vs. T_j

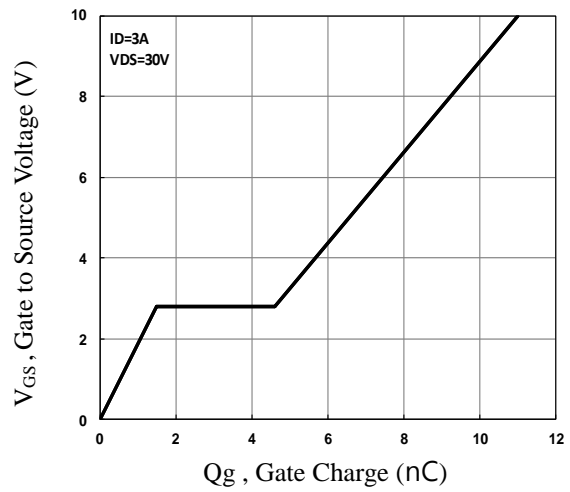

Fig.4 Gate Charge Waveform

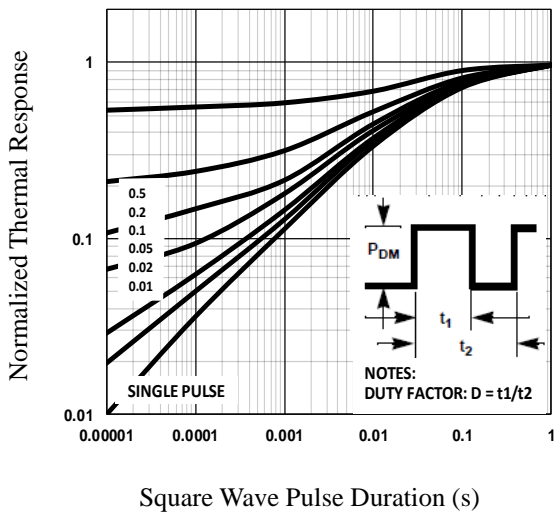

Fig.5 Normalized Transient Impedance

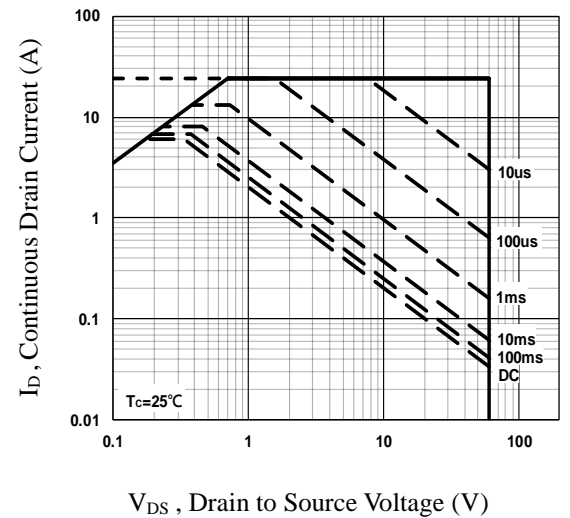

Fig.6 Maximum Safe Operation Area

P-CH Electrical Characteristics (T_J=25 °C, unless otherwise)
Off Characteristics

Symbol	Parameter	Conditions	Min.	Typ.	Max.	Unit
BV _{DSS}	Drain-Source Breakdown Voltage	V _{GS} =0V, I _D =-250uA	-60	---	---	V
I _{DSS}	Drain-Source Leakage Current	V _{DS} =-60V, V _{GS} =0V, T _J =25°C	---	---	-1	uA
		V _{DS} =-48V, V _{GS} =0V, T _J =125°C	---	---	-10	uA
I _{GSS}	Gate-Source Leakage Current	V _{GS} =±20V, V _{DS} =0V	---	---	±100	nA

On Characteristics

R _{DS(ON)}	Static Drain-Source On-Resistance	V _{GS} =-10V, I _D =-3A	---	58	70	mΩ
		V _{GS} =-4.5V, I _D =-2A	---	72	94	mΩ
V _{GS(th)}	Gate Threshold Voltage	V _{GS} =V _{DS} , I _D =-250uA	-1.2	-1.6	-2.5	V
g _{fs}	Forward Transconductance	V _{DS} =-10V, I _D =-2A	---	5	---	S

Dynamic and switching Characteristics

Q _g	Total Gate Charge ^{4, 5}	V _{DS} =-30V, V _{GS} =-10V, I _D =-2A	---	14	21	nC
Q _{gs}	Gate-Source Charge ^{4, 5}		---	1.4	3	
Q _{gd}	Gate-Drain Charge ^{4, 5}		---	3.3	5	
T _{d(on)}	Turn-On Delay Time ^{4, 5}	V _{DD} =-30V, V _{GS} =-10V, R _G =6Ω I _D =-2A	---	8	15	ns
T _r	Rise Time ^{4, 5}		---	25	40	
T _{d(off)}	Turn-Off Delay Time ^{4, 5}		---	50	75	
T _f	Fall Time ^{4, 5}		---	16	25	
C _{iss}	Input Capacitance	V _{DS} =-30V, V _{GS} =0V, F=1MHz	---	880	1320	pF
C _{oss}	Output Capacitance		---	60	90	
C _{rss}	Reverse Transfer Capacitance		---	45	70	
R _g	Gate resistance	V _{GS} =0V, V _{DS} =0V, F=1MHz	---	16	---	Ω

Drain-Source Diode Characteristics and Maximum Ratings

Symbol	Parameter	Conditions	Min.	Typ.	Max.	Unit
I _S	Continuous Source Current	V _G =V _D =0V, Force Current	---	---	-4.5	A
I _{SM}	Pulsed Source Current		---	---	-9	A
V _{SD}	Diode Forward Voltage	V _{GS} =0V, I _S =-1A, T _J =25°C	---	---	-1	V
T _{rr}	Reverse Recovery Time	V _R =-50V, I _S =-2A	---	35	---	ns
Q _{rr}	Reverse Recovery Charge	di/dt=100A/μs, T _J =25°C	---	20	---	nC

Note :

4. The data tested by pulsed, pulse width ≤ 300us, duty cycle ≤ 2%.
5. Essentially independent of operating temperature.

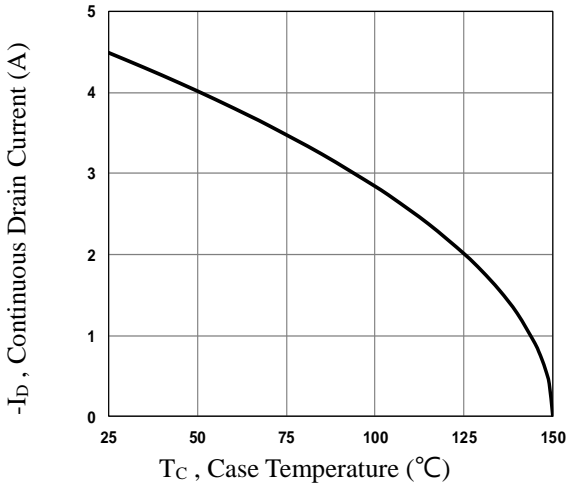

Fig.7 Continuous Drain Current vs. T_c

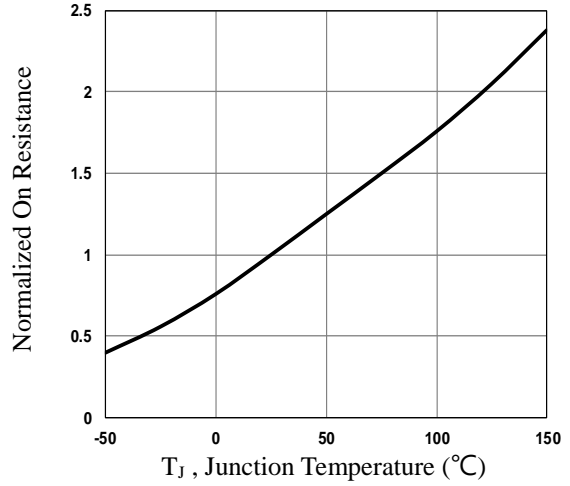

Fig.8 Normalized $R_{DS(on)}$ vs. T_j

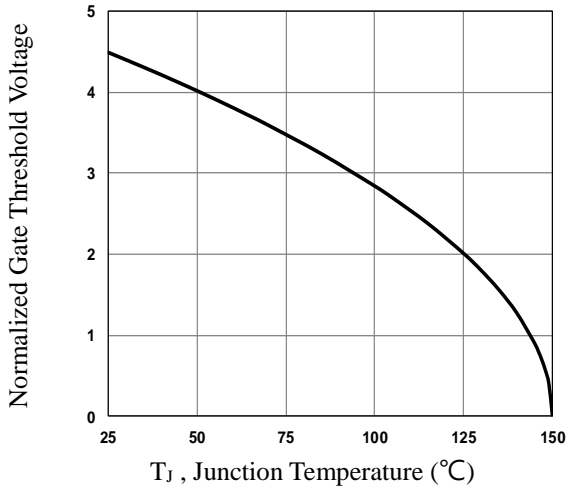

Fig.9 Normalized V_{th} vs. T_j

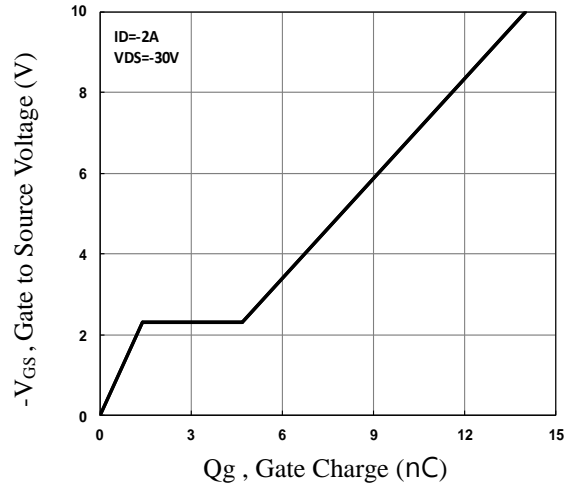

Fig.10 Gate Charge Waveform

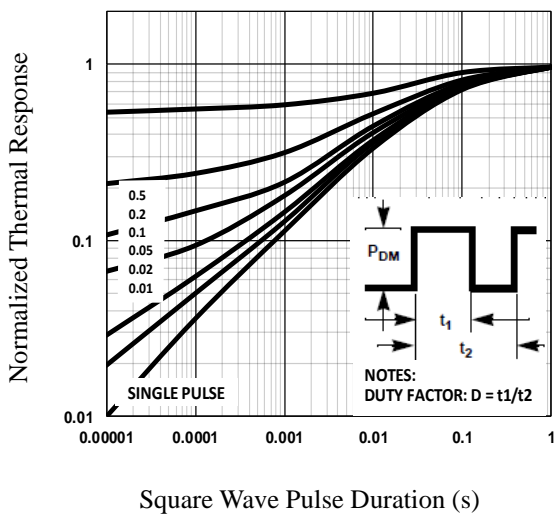

Fig.11 Normalized Transient Impedance

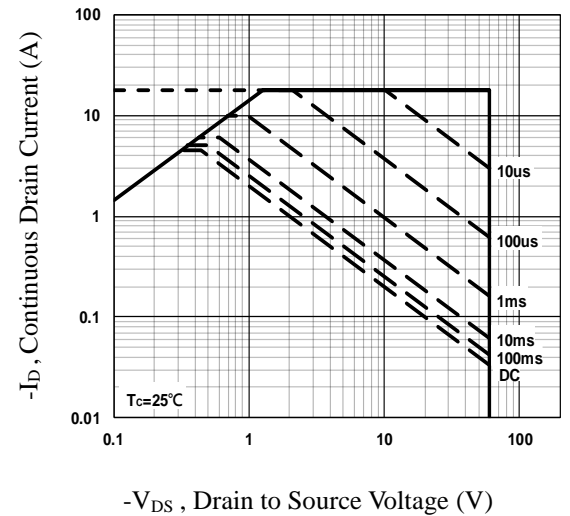

Fig.12 Maximum Safe Operation Area

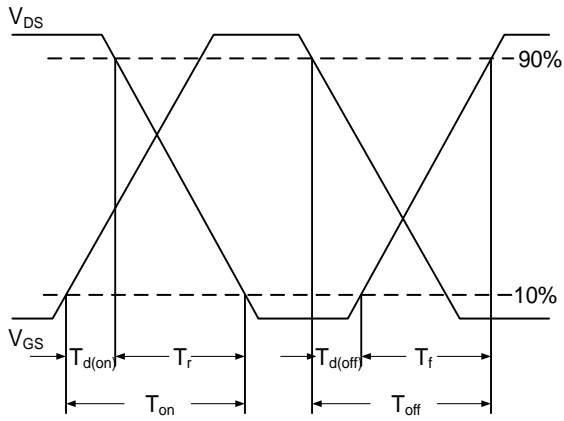

Fig.13 Switching Time Waveform

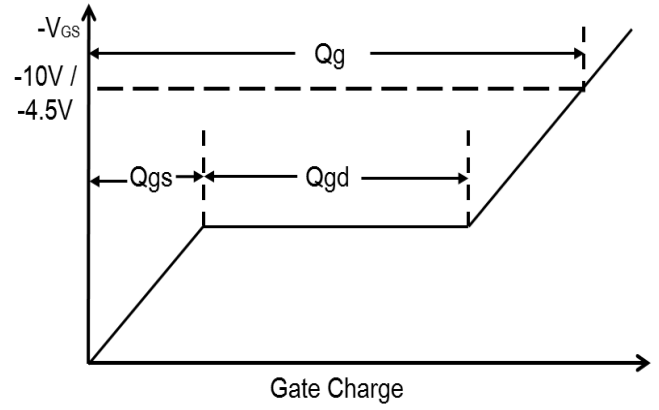
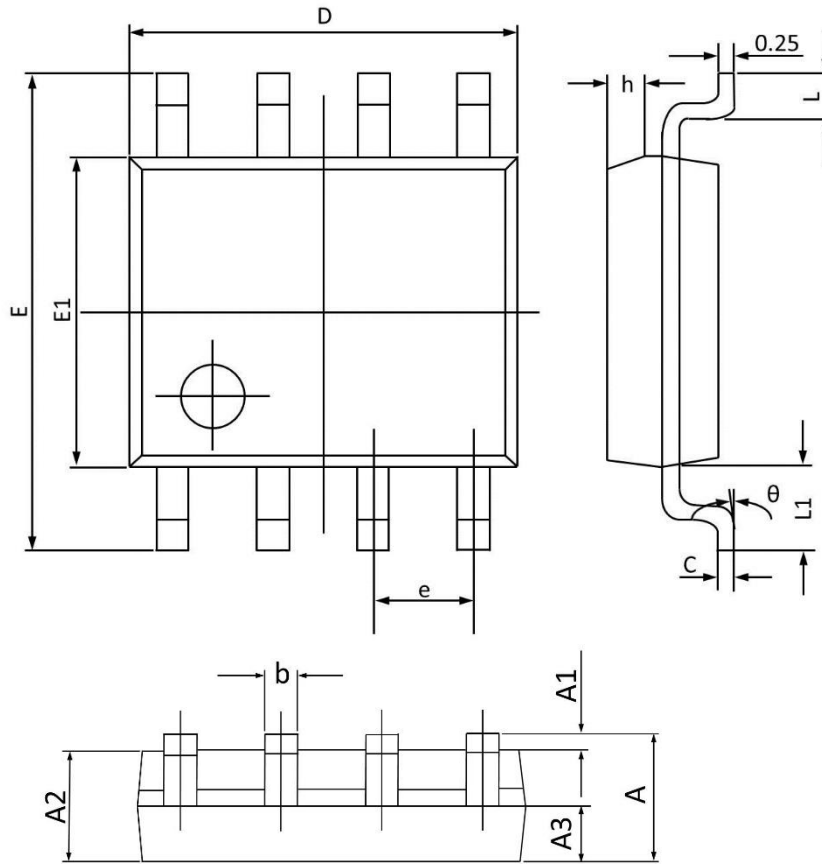

Fig.14 Gate Charge Waveform

SOP8 PACKAGE INFORMATION



Symbol	Dimensions In Millimeters		Dimensions In Inches	
	Min	Max	Min	Max
A	1.350	1.800	0.053	0.069
A1	0.050	0.250	0.002	0.010
A2	1.250	1.650	0.049	0.065
A3	0.500	0.700	0.020	0.028
b	0.300	0.510	0.012	0.020
c	0.150	0.260	0.006	0.010
D	4.700	5.100	0.185	0.201
E	5.800	6.200	0.228	0.244
E1	3.700	4.100	0.146	0.161
e	1.270(BSC)		0.050(BSC)	
h	0.250	0.500	0.010	0.020
L	0.400	1.000	0.016	0.039
L1	1.050(BSC)		0.041(BSC)	
θ	0°	8°	0°	8°