

General Description

These N-Channel enhancement mode power field effect transistors are using trench DMOS technology. This advanced technology has been especially tailored to minimize on-state resistance, provide superior switching performance, and withstand high energy pulse in the avalanche and commutation mode. These devices are well suited for high efficiency fast switching applications.

BVDSS	RDSON	ID
150V	16mΩ	45A

Features

- 150V,45A, RDS(ON) =16mΩ @VGS = 10V
- Improved dv/dt capability
- Fast switching
- 100% EAS Guaranteed
- Green Device Available

TO220F Pin Configuration

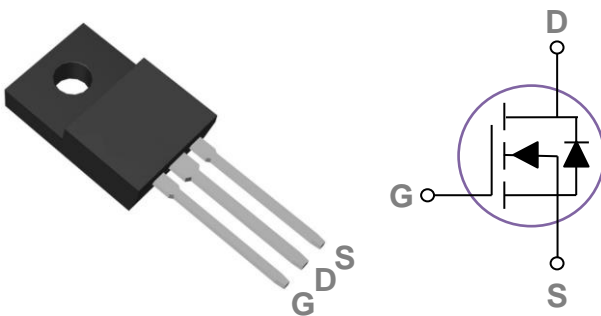

Applications

- Networking
- Load Switch
- LED applications
- Quick Charger

Absolute Maximum Ratings $T_c=25^\circ\text{C}$ unless otherwise noted

Symbol	Parameter	Rating	Units
V_{DS}	Drain-Source Voltage	150	V
V_{GS}	Gate-Source Voltage	± 20	V
I_D	Drain Current – Continuous ($T_c=25^\circ\text{C}$)	45	A
	Drain Current – Continuous ($T_c=100^\circ\text{C}$)	29	A
I_{DM}	Drain Current – Pulsed ¹	180	A
EAS	Single Pulse Avalanche Energy ²	312	mJ
IAS	Single Pulse Avalanche Current ²	25	A
P_D	Power Dissipation ($T_c=25^\circ\text{C}$)	89	W
	Power Dissipation – Derate above 25°C	0.71	W/ $^\circ\text{C}$
T_{STG}	Storage Temperature Range	-55 to 150	$^\circ\text{C}$
T_J	Operating Junction Temperature Range	-55 to 150	$^\circ\text{C}$

Thermal Characteristics

Symbol	Parameter	Typ.	Max.	Unit
$R_{\theta JA}$	Thermal Resistance Junction to ambient	---	62	$^\circ\text{C}/\text{W}$
$R_{\theta JC}$	Thermal Resistance Junction to Case	---	1.4	$^\circ\text{C}/\text{W}$

Electrical Characteristics (T_J=25 °C, unless otherwise noted)
Off Characteristics

Symbol	Parameter	Conditions	Min.	Typ.	Max.	Unit
BV _{DSS}	Drain-Source Breakdown Voltage	V _{GS} =0V, I _D =250μA	150	---	---	V
I _{DSS}	Drain-Source Leakage Current	V _{DS} =120V, V _{GS} =0V, T _J =25°C	---	---	1	μA
		V _{DS} =120V, V _{GS} =0V, T _J =85°C	---	---	10	μA
I _{GSS}	Gate-Source Leakage Current	V _{GS} =±20V, V _{DS} =0V	---	---	±100	nA

On Characteristics

R _{DS(ON)}	Static Drain-Source On-Resistance ³	V _{GS} =10V, I _D =25A	---	13	16	mΩ
V _{GS(th)}	Gate Threshold Voltage	V _{GS} =V _{DS} , I _D =250μA	2	3	4	V
g _{fs}	Forward Transconductance	V _{DS} =10V, I _D =3A	---	12	---	S

Dynamic and switching Characteristics

Q _g	Total Gate Charge ^{3, 4}	V _{DS} =75V, V _{GS} =10V, I _D =25A	---	42	65	nC
Q _{gs}	Gate-Source Charge ^{3, 4}		---	9.5	15	
Q _{gd}	Gate-Drain Charge ^{3, 4}		---	17	25	
T _{d(on)}	Turn-On Delay Time ^{3, 4}	V _{DD} =75V, V _{GS} =10V, R _G =6Ω I _D =25A	---	15	23	ns
T _r	Rise Time ^{3, 4}		---	28	42	
T _{d(off)}	Turn-Off Delay Time ^{3, 4}		---	45	68	
T _f	Fall Time ^{3, 4}		---	32	48	
C _{iss}	Input Capacitance	V _{DS} =75V, V _{GS} =0V, F=1MHz	---	2300	3450	pF
C _{oss}	Output Capacitance		---	220	330	
C _{rss}	Reverse Transfer Capacitance		---	10	15	
R _g	Gate Resistance	V _{GS} =0V, V _{DS} =0V, F=1MHz	---	1.5	---	Ω

Drain-Source Diode Characteristics and Maximum Ratings

Symbol	Parameter	Conditions	Min.	Typ.	Max.	Unit
I _S	Continuous Source Current	V _G =V _D =0V, Force Current	---	---	45	A
I _{SM}	Pulsed Source Current		---	---	90	A
V _{SD}	Diode Forward Voltage	V _{GS} =0V, I _S =1A, T _J =25°C	---	---	1	V
t _{rr}	Reverse Recovery Time ³	V _R =100V, I _S =10A	---	80	---	ns
Q _{rr}	Reverse Recovery Charge ³	di/dt=100A/μs, T _J =25°C	---	260	---	nC

Note :

1. Repetitive Rating : Pulsed width limited by maximum junction temperature.
2. V_{DD}=50V, V_{GS}=10V, L=1mH, I_{AS}=25A., R_G=25Ω, Starting T_J=25°C.
3. The data tested by pulsed, pulse width ≤ 300us, duty cycle ≤ 2%.
4. Essentially independent of operating temperature.

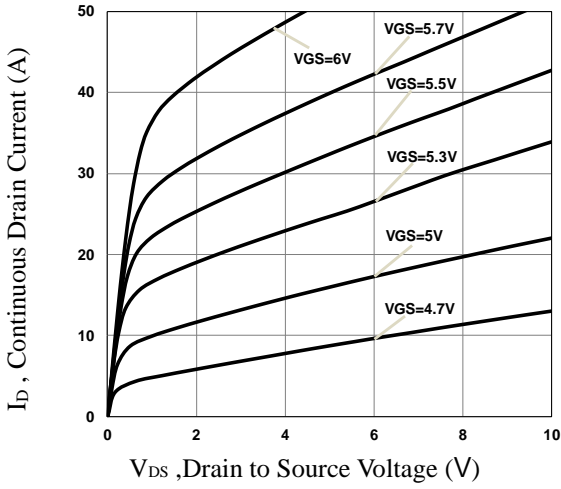

Fig.1 Typical Output Characteristics

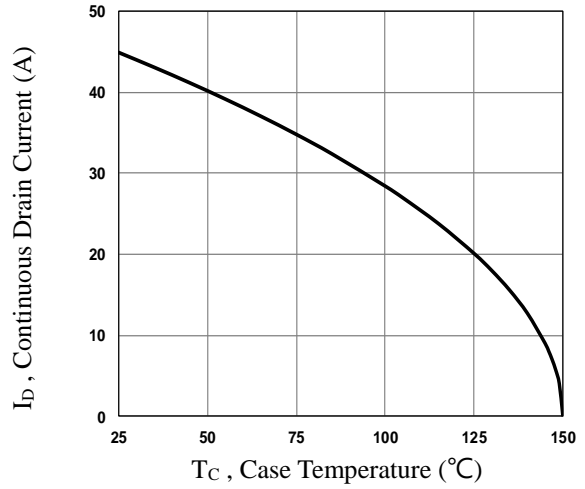

Fig.2 Continuous Drain Current vs. T_c

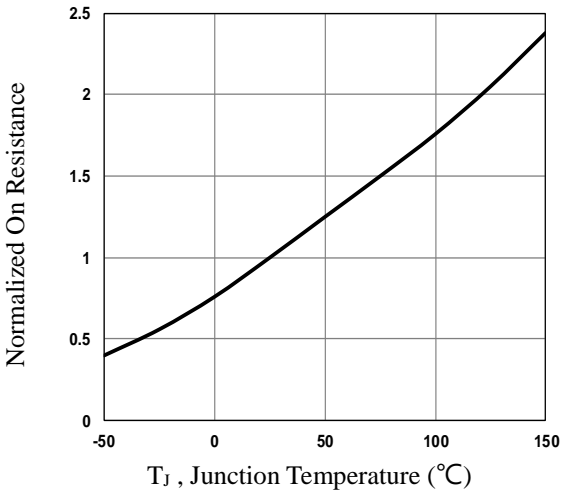

Fig.3 Normalized R_{DS(on)} vs. T_j

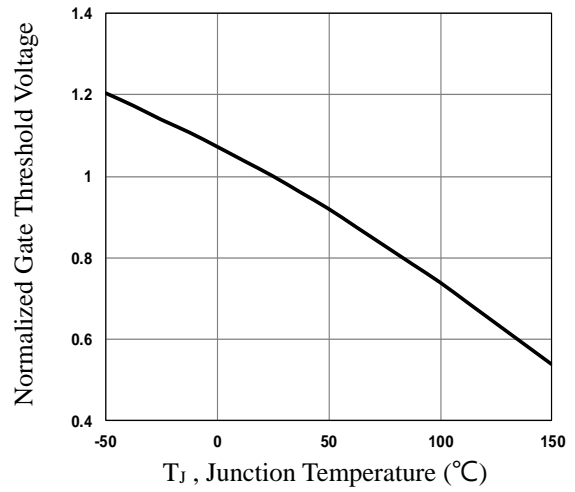

Fig.4 Normalized V_{th} vs. T_j

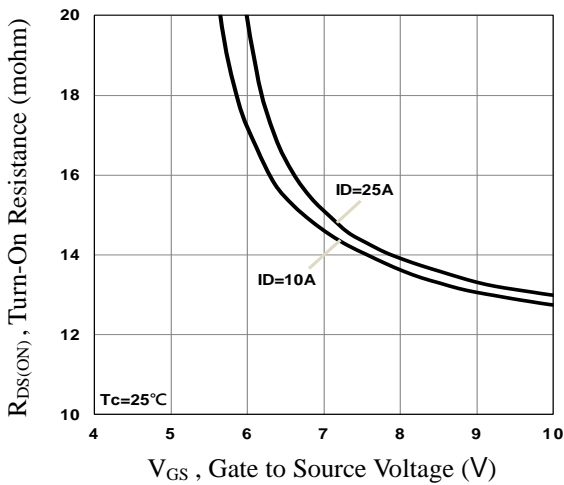

Fig.5 Turn-On Resistance vs. V_{GS}

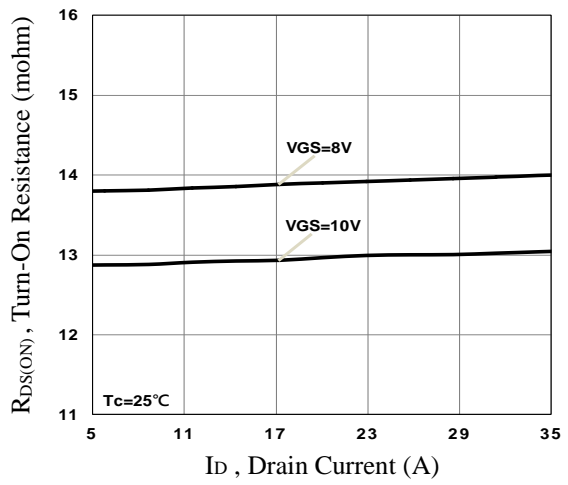

Fig.6 Turn-On Resistance vs. I_D

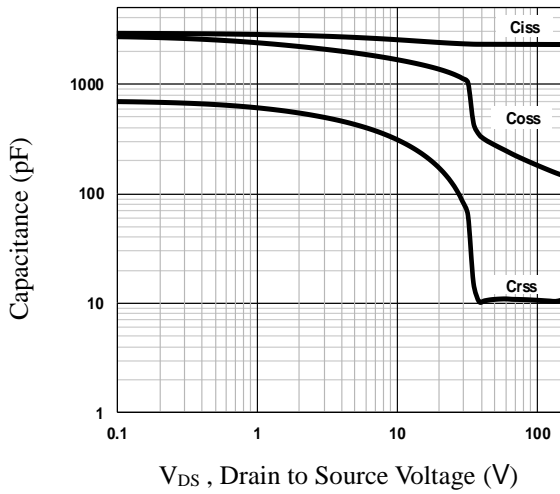

Fig.7 Capacitance Characteristics

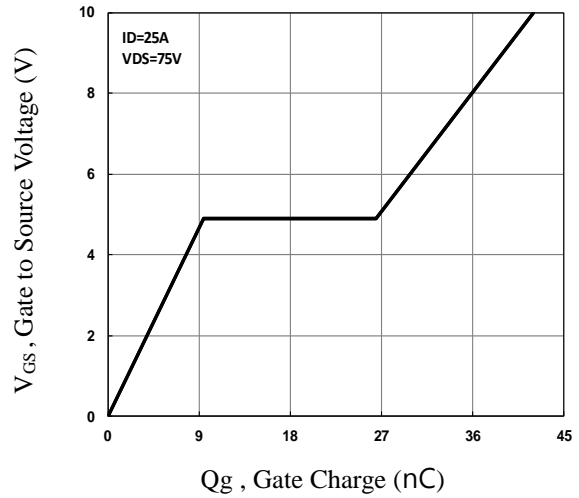

Fig.8 Gate Charge Characteristics

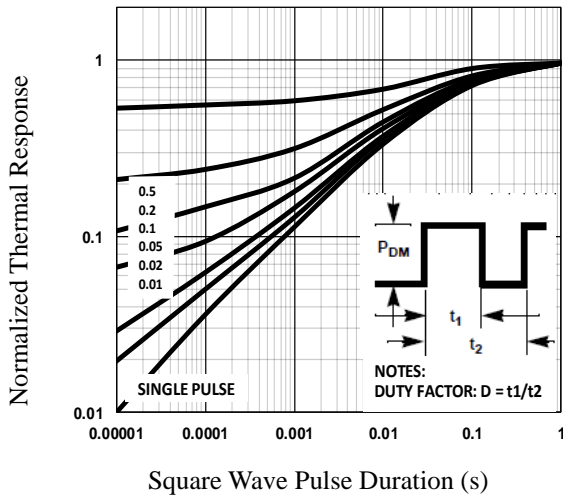

Fig.9 Normalized Transient Impedance

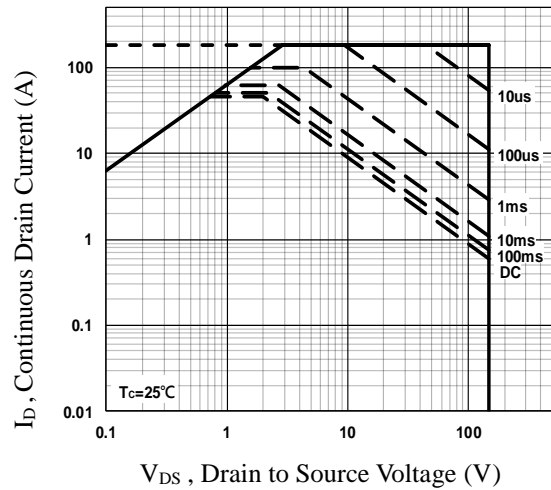

Fig.10 Maximum Safe Operation Area

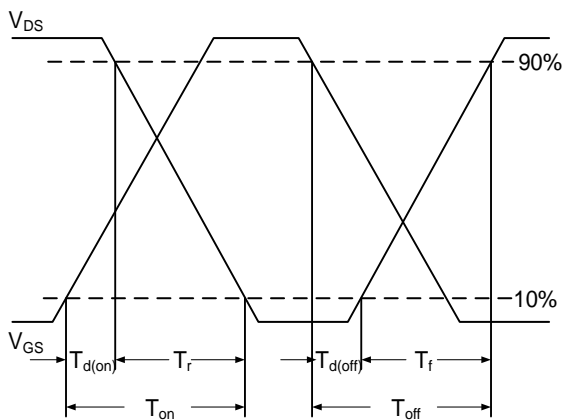

Fig.11 Switching Time Waveform

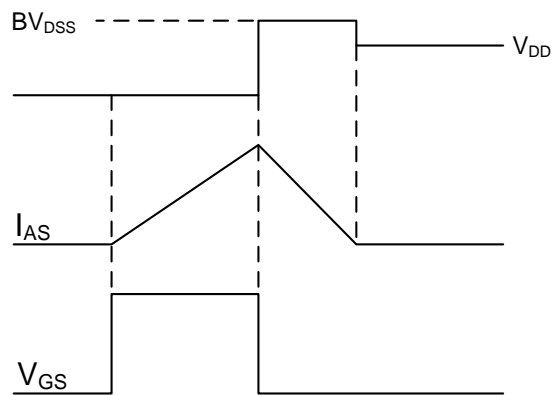
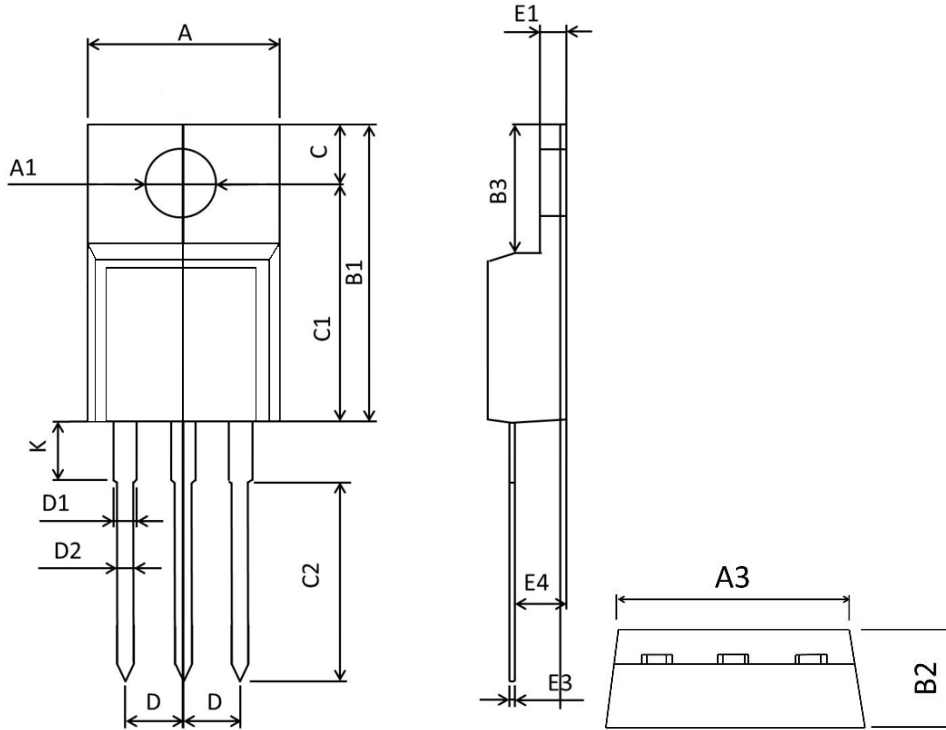

Fig.12 EAS Waveform

TO220F PACKAGE INFORMATION



Symbol	Dimensions In Millimeters		Dimensions In Inches	
	Min	Max	Min	Max
A	9.860	10.460	0.389	0.411
A1	3.100	3.500	0.122	0.138
B1	15.450	16.300	0.608	0.642
B2	4.400	5.000	0.173	0.197
B3	6.280	7.100	0.247	0.280
C	3.100	3.500	0.122	0.138
C1	12.270	12.870	0.483	0.507
C2	9.600	10.520	0.378	0.414
D	2.540BSC		0.1BSC	
D1	1.070	1.470	0.042	0.058
D2	0.600	1.000	0.024	0.039
K	2.800	3.500	0.110	0.138
E1	2.340	2.740	0.092	0.108
E3	0.350	0.650	0.014	0.026
E4	2.460	2.960	0.097	0.117