

### General Description

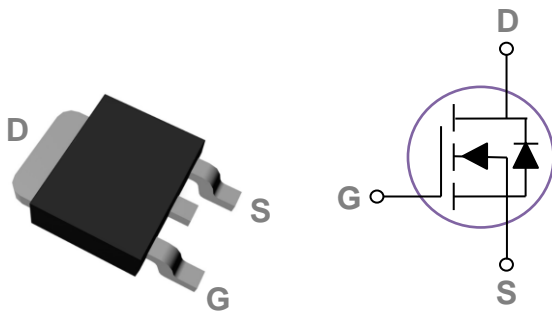
These N-Channel enhancement mode power field effect transistors are using Super Junction technology. This advanced technology has been especially tailored to minimize on-state resistance, provide superior switching performance, and withstand high energy pulse in the avalanche and commutation mode. These devices are well suited for high efficiency switch mode power supply

BVDSS	RDSON	ID
650V	360mΩ	11A

### Features

- 650V, 11A,  $R_{DS(ON)} = 360m\Omega @ V_{GS} = 10V$
- Improved  $dv/dt$  capability
- Fast switching
- 100% EAS Guaranteed
- Green Device Available

### TO252 Pin Configuration



### Applications

- High efficient switched mode power supplies
- LED Lighting
- Adapter/charger

### Absolute Maximum Ratings (T<sub>C</sub>=25°C unless otherwise noted)

Symbol	Parameter	Rating	Units
V <sub>DS</sub>	Drain-Source Voltage	650	V
V <sub>GS</sub>	Gate-Source Voltage	±30	V
I <sub>D</sub>	Drain Current – Continuous (T <sub>C</sub> =25°C)	11	A
	Drain Current – Continuous (T <sub>C</sub> =100°C)	6.9	A
I <sub>DM</sub>	Drain Current – Pulsed <sup>1</sup>	44	A
EAS	Single Pulse Avalanche Energy	210	mJ
P <sub>D</sub>	Power Dissipation (T <sub>C</sub> =25°C)	75	W
	Power Dissipation – Derate above 25°C	0.6	W/°C
T <sub>STG</sub>	Storage Temperature Range	-55 to 150	°C
T <sub>J</sub>	Operating Junction Temperature Range	-55 to 150	°C

### Thermal Characteristics

Symbol	Parameter	Typ.	Max.	Unit
R <sub>θJA</sub>	Thermal Resistance Junction to ambient	---	62.5	°C/W
R <sub>θJC</sub>	Thermal Resistance Junction to Case	---	1.65	°C/W

**Electrical Characteristics (T<sub>J</sub>=25 °C, unless otherwise noted)**
**Off Characteristics**

Symbol	Parameter	Conditions	Min.	Typ.	Max.	Unit
BV <sub>DSS</sub>	Drain-Source Breakdown Voltage	V <sub>GS</sub> =0V, I <sub>D</sub> =1mA	650	---	---	V
I <sub>DSS</sub>	Drain-Source Leakage Current	V <sub>DS</sub> =650V, V <sub>GS</sub> =0V, T <sub>J</sub> =25°C	---	---	1	μA
		V <sub>DS</sub> =520V, V <sub>GS</sub> =0V, T <sub>J</sub> =125°C	---	---	10	μA
I <sub>GSS</sub>	Gate-Source Leakage Current	V <sub>GS</sub> =±30V, V <sub>DS</sub> =0V	---	---	±100	nA

**On Characteristics**

R <sub>DS(ON)</sub>	Static Drain-Source On-Resistance	V <sub>GS</sub> =10V, I <sub>D</sub> =4A	---	320	360	mΩ
V <sub>GS(th)</sub>	Gate Threshold Voltage	V <sub>GS</sub> =V <sub>DS</sub> , I <sub>D</sub> =250μA	2	3	4	V

**Dynamic and switching Characteristics**

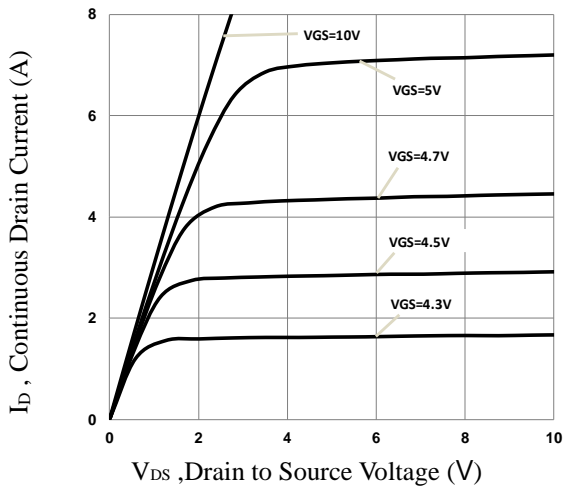
Q <sub>g</sub>	Total Gate Charge <sup>2,3</sup>	V <sub>DS</sub> =480V, V <sub>GS</sub> =10V, I <sub>D</sub> =6A	---	21	32	nC
Q <sub>gs</sub>	Gate-Source Charge <sup>2,3</sup>		---	4	6	
Q <sub>gd</sub>	Gate-Drain Charge <sup>2,3</sup>		---	7	11	
T <sub>d(on)</sub>	Turn-On Delay Time <sup>2,3</sup>	V <sub>DD</sub> =480V, V <sub>GS</sub> =10V, R <sub>G</sub> =25Ω I <sub>D</sub> =6A	---	18	27	ns
T <sub>r</sub>	Rise Time <sup>2,3</sup>		---	41	62	
T <sub>d(off)</sub>	Turn-Off Delay Time <sup>2,3</sup>		---	110	165	
T <sub>f</sub>	Fall Time <sup>2,3</sup>		---	39	59	
C <sub>iss</sub>	Input Capacitance	V <sub>DS</sub> =100V, V <sub>GS</sub> =0V, F=1MHz	---	670	1005	pF
C <sub>oss</sub>	Output Capacitance		---	30	45	
C <sub>rss</sub>	Reverse Transfer Capacitance		---	1.5	5.3	
R <sub>g</sub>	Gate resistance	V <sub>GS</sub> =0V, V <sub>DS</sub> =0V, F=1MHz	---	20	---	Ω

**Drain-Source Diode Characteristics and Maximum Ratings**

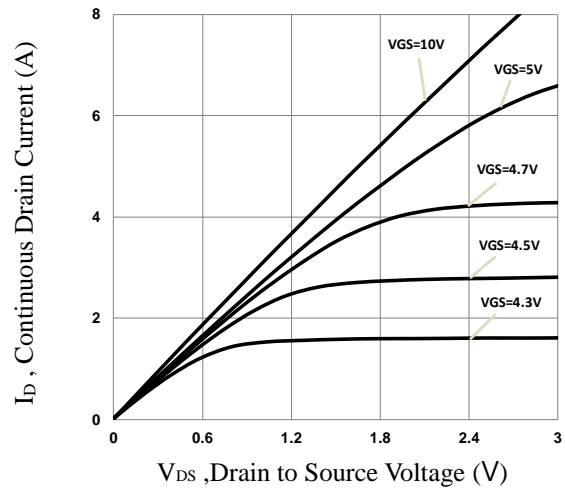
Symbol	Parameter	Conditions	Min.	Typ.	Max.	Unit
I <sub>S</sub>	Continuous Source Current	V <sub>G</sub> =V <sub>D</sub> =0V, Force Current	---	---	11	A
I <sub>SM</sub>	Pulsed Source Current		---	---	22	A
V <sub>SD</sub>	Diode Forward Voltage	V <sub>GS</sub> =0V, I <sub>S</sub> =6A, T <sub>J</sub> =25°C	---	---	1.4	V
t <sub>rr</sub>	Reverse Recovery Time <sup>2</sup>	V <sub>R</sub> =400V, I <sub>S</sub> =10A, di/dt=100A/μs, T <sub>J</sub> =25°C	---	320	---	ns
Q <sub>rr</sub>	Reverse Recovery Charge <sup>2</sup>		---	3.8	---	μC

Note :

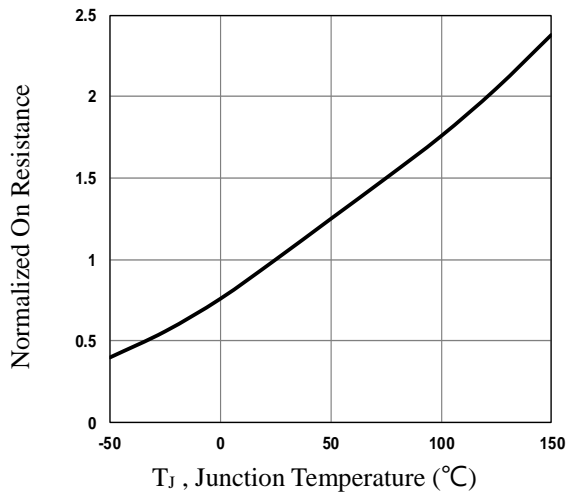
1. Repetitive Rating : Pulsed width limited by maximum junction temperature.
2. The data tested by pulsed, pulse width ≤ 300us, duty cycle ≤ 2%.
3. Essentially independent of operating temperature.



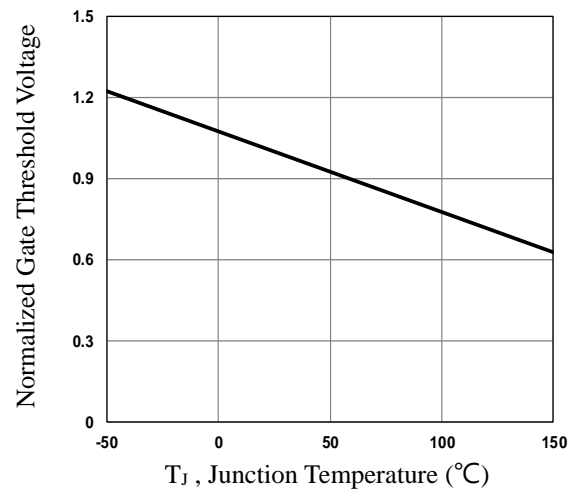
**Fig.1 Typical Output Characteristics**



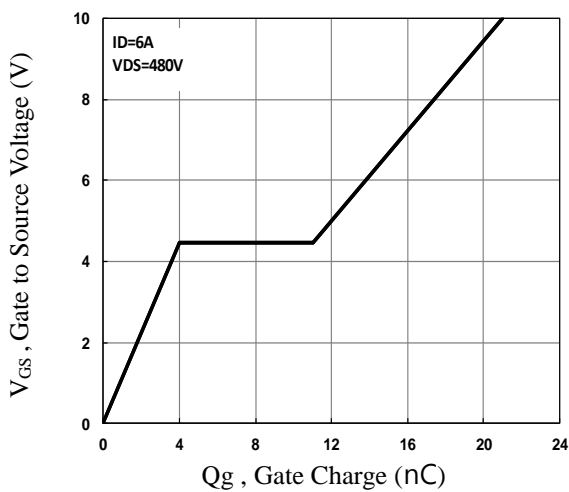
**Fig.2 Typical Output Characteristics**



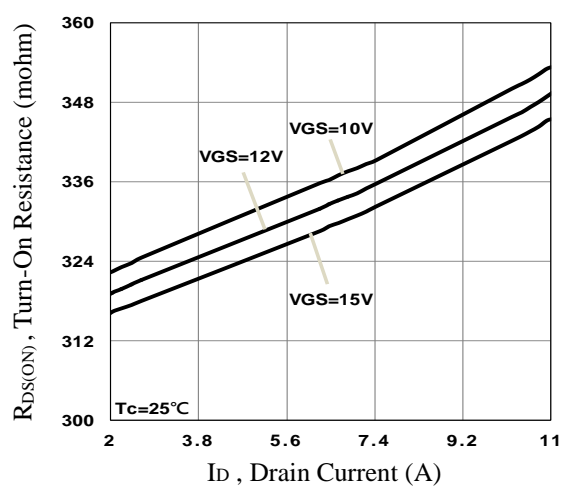
**Fig.3 Normalized  $R_{DS(on)}$  vs.  $T_J$**



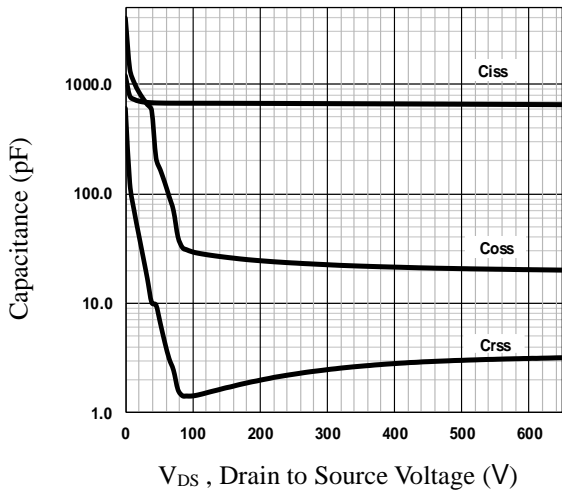
**Fig.4 Normalized  $V_{th}$  vs.  $T_J$**



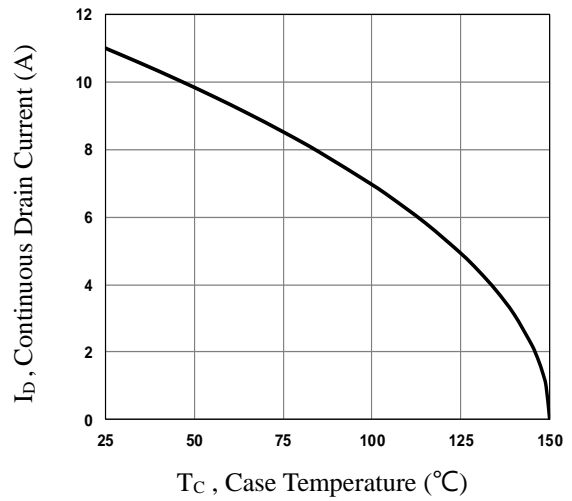
**Fig.5 Gate Charge Characteristics**



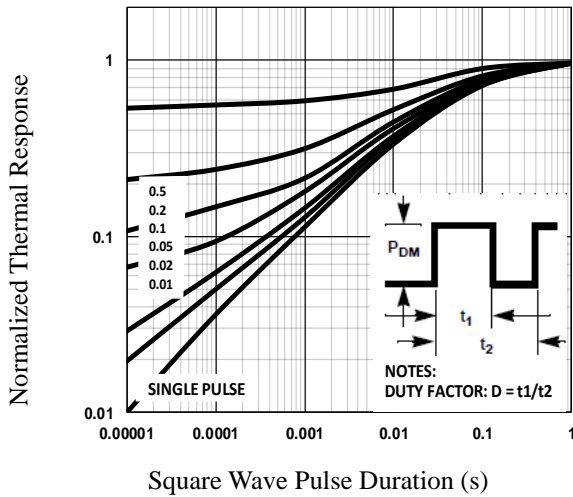
**Fig.6 Turn-On Resistance vs.  $I_D$**



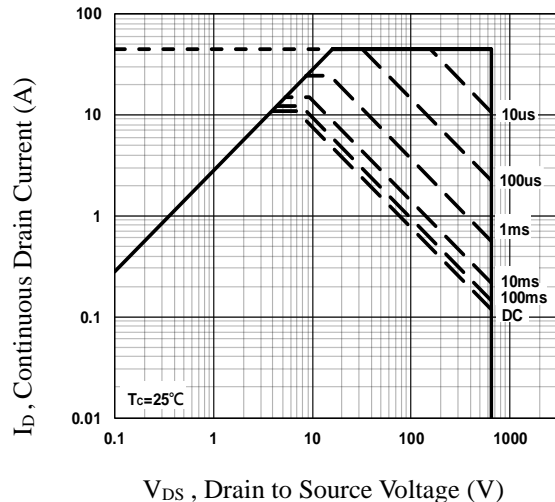
**Fig.7 Capacitance Characteristics**



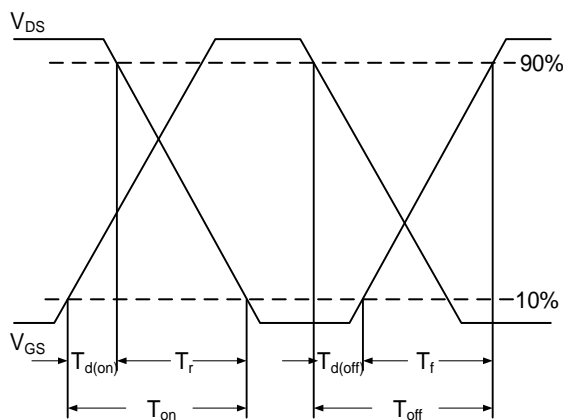
**Fig.8 Continuous Drain Current vs. T<sub>c</sub>**



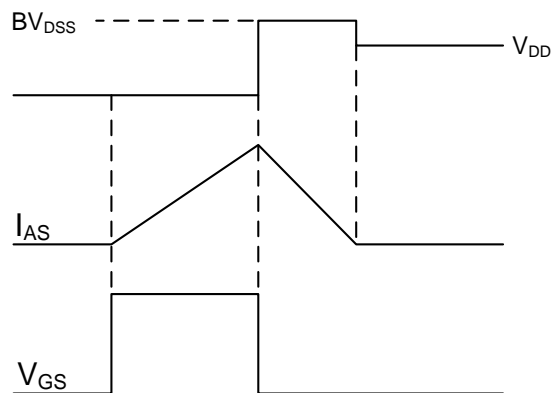
**Fig.9 Normalized Transient Impedance**



**Fig.10 Maximum Safe Operation Area**

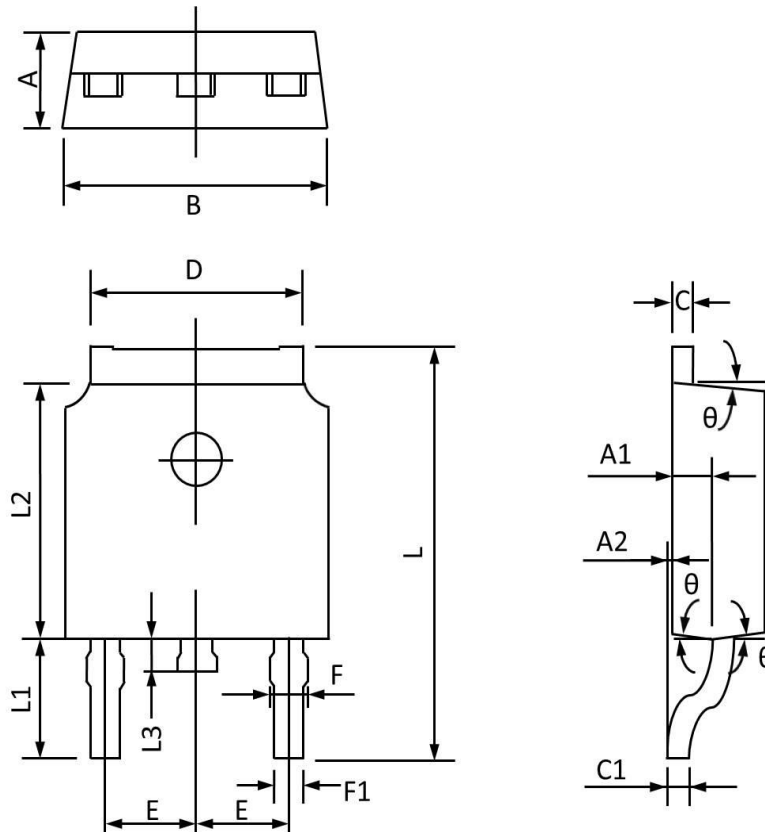


**Fig.11 Switching Time Waveform**



**Fig.12 EAS Waveform**

TO252 PACKAGE INFORMATION



Symbol	Dimensions In Millimeters		Dimensions In Inches	
	MAX	MIN	MAX	MIN
A	2.450	2.150	0.096	0.085
A1	1.200	0.910	0.047	0.036
A2	0.150	0.000	0.006	0.000
B	6.800	6.300	0.268	0.248
C	0.580	0.350	0.023	0.014
C1	0.550	0.380	0.022	0.015
D	5.500	5.100	0.217	0.201
E	2.390	2.000	0.094	0.079
F	0.940	0.600	0.037	0.024
F1	0.860	0.500	0.034	0.020
L	10.400	9.400	0.409	0.370
L1	3.000	2.400	0.118	0.094
L2	6.200	5.300	0.244	0.209
L3	1.200	0.600	0.047	0.024
θ	9°	3°	9°	3°