

### General Description

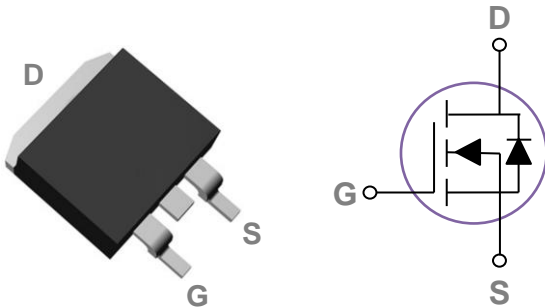
These N-Channel enhancement mode power field effect transistors are using trench DMOS technology. This advanced technology has been especially tailored to minimize on-state resistance, provide superior switching performance, and withstand high energy pulse in the avalanche and commutation mode. These devices are well suited for high efficiency fast switching applications.

BVDSS	RDSON	ID
40V	2.4mΩ	170A

### Features

- 40V, 170A,  $R_{DS(ON)} = 2.4m\Omega$  @  $V_{GS} = 10V$
- Improved  $dv/dt$  capability
- Fast switching
- Green Device Available

### TO263 Pin Configuration



### Applications

- Networking
- Load Switch
- LED applications
- Quick Charger

### Absolute Maximum Ratings $T_c=25^\circ\text{C}$ unless otherwise noted

Symbol	Parameter	Rating	Units
$V_{DS}$	Drain-Source Voltage	40	V
$V_{GS}$	Gate-Source Voltage	$\pm 20$	V
$I_D$	Drain Current – Continuous ( $T_c=25^\circ\text{C}$ )	170	A
	Drain Current – Continuous ( $T_c=100^\circ\text{C}$ )	109	A
$I_{DM}$	Drain Current – Pulsed <sup>1</sup>	680	A
EAS	Single Pulse Avalanche Energy <sup>2</sup>	259	mJ
IAS	Single Pulse Avalanche Current <sup>2</sup>	72	A
$P_D$	Power Dissipation ( $T_c=25^\circ\text{C}$ )	151	W
	Power Dissipation – Derate above $25^\circ\text{C}$	1.2	W/ $^\circ\text{C}$
$T_{STG}$	Storage Temperature Range	-55 to 150	$^\circ\text{C}$
$T_J$	Operating Junction Temperature Range	-55 to 150	$^\circ\text{C}$

### Thermal Characteristics

Symbol	Parameter	Typ.	Max.	Unit
$R_{\theta JA}$	Thermal Resistance Junction to ambient	---	62	$^\circ\text{C}/\text{W}$
$R_{\theta JC}$	Thermal Resistance Junction to Case	---	0.83	$^\circ\text{C}/\text{W}$

**Electrical Characteristics (T<sub>J</sub>=25 °C, unless otherwise noted)**
**Off Characteristics**

Symbol	Parameter	Conditions	Min.	Typ.	Max.	Unit
BV <sub>DSS</sub>	Drain-Source Breakdown Voltage	V <sub>GS</sub> =0V, I <sub>D</sub> =250uA	40	---	---	V
I <sub>DSS</sub>	Drain-Source Leakage Current	V <sub>DS</sub> =40V, V <sub>GS</sub> =0V, T <sub>J</sub> =25°C	---	---	1	uA
		V <sub>DS</sub> =32V, V <sub>GS</sub> =0V, T <sub>J</sub> =100°C	---	---	10	uA
I <sub>GSS</sub>	Gate-Source Leakage Current	V <sub>GS</sub> =±20V, V <sub>DS</sub> =0V	---	---	±100	nA

**On Characteristics**

R <sub>DS(ON)</sub>	Static Drain-Source On-Resistance	V <sub>GS</sub> =10V, I <sub>D</sub> =20A	---	2	2.4	mΩ
		V <sub>GS</sub> =4.5V, I <sub>D</sub> =15A	---	2.9	3.8	mΩ
V <sub>GS(th)</sub>	Gate Threshold Voltage	V <sub>GS</sub> =V <sub>DS</sub> , I <sub>D</sub> =250uA	1.2	1.6	2.5	V
g <sub>fs</sub>	Forward Transconductance	V <sub>DS</sub> =10V, I <sub>S</sub> =3A	---	9	---	S

**Dynamic and switching Characteristics**

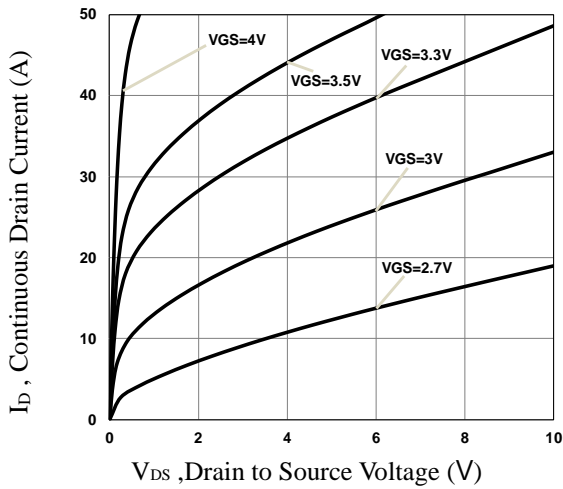
Q <sub>g</sub>	Total Gate Charge <sup>3, 4</sup>	V <sub>DS</sub> =20V, V <sub>GS</sub> =10V, I <sub>D</sub> =85A	---	52	80	nC
Q <sub>gs</sub>	Gate-Source Charge <sup>3, 4</sup>		---	8.3	15	
Q <sub>gd</sub>	Gate-Drain Charge <sup>3, 4</sup>		---	14	21	
T <sub>d(on)</sub>	Turn-On Delay Time <sup>3, 4</sup>	V <sub>DD</sub> =20V, V <sub>GS</sub> =10V, R <sub>G</sub> =6Ω I <sub>D</sub> =85A	---	10	15	ns
T <sub>r</sub>	Rise Time <sup>3, 4</sup>		---	15	25	
T <sub>d(off)</sub>	Turn-Off Delay Time <sup>3, 4</sup>		---	20	30	
T <sub>f</sub>	Fall Time <sup>3, 4</sup>		---	30	45	
C <sub>iss</sub>	Input Capacitance	V <sub>DS</sub> =20V, V <sub>GS</sub> =0V, F=1MHz	---	2950	4450	pF
C <sub>oss</sub>	Output Capacitance		---	1100	1650	
C <sub>rss</sub>	Reverse Transfer Capacitance		---	58	90	
R <sub>g</sub>	Gate resistance	V <sub>GS</sub> =0V, V <sub>DS</sub> =0V, F=1MHz	---	0.9	---	Ω

**Drain-Source Diode Characteristics and Maximum Ratings**

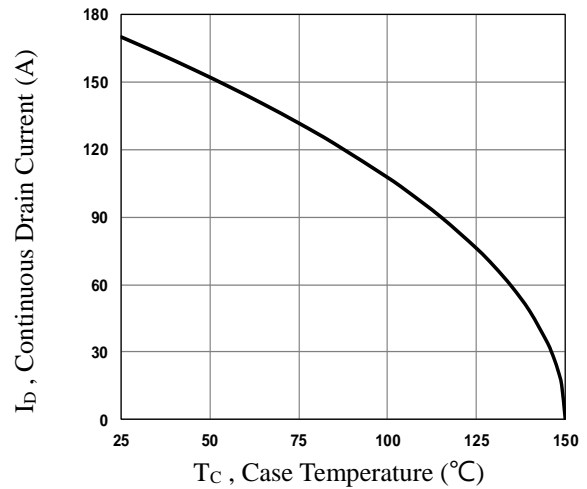
Symbol	Parameter	Conditions	Min.	Typ.	Max.	Unit
I <sub>S</sub>	Continuous Source Current	V <sub>G</sub> =V <sub>D</sub> =0V, Force Current	---	---	170	A
I <sub>SM</sub>	Pulsed Source Current		---	---	340	A
V <sub>SD</sub>	Diode Forward Voltage	V <sub>GS</sub> =0V, I <sub>S</sub> =1A, T <sub>J</sub> =25°C	---	---	1	V
T <sub>rr</sub>	Reverse Recovery Time	V <sub>R</sub> =30V, I <sub>S</sub> =10A	---	70	---	ns
Q <sub>rr</sub>	Reverse Recovery Charge	di/dt=100A/μs T <sub>J</sub> =25°C	---	100	---	nC

Note :

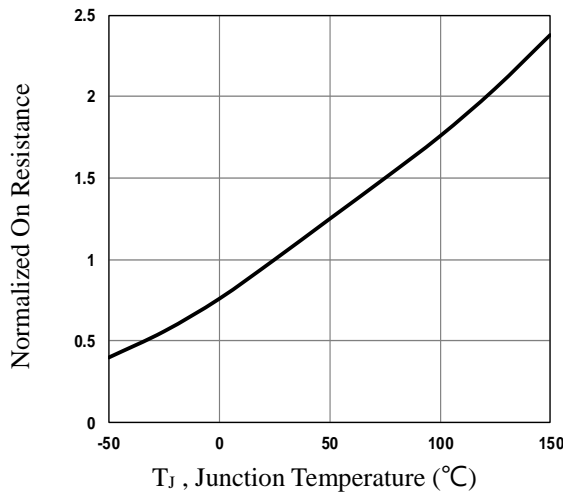
1. Repetitive Rating : Pulsed width limited by maximum junction temperature.
2. V<sub>DD</sub>=25V, V<sub>GS</sub>=10V, L=0.1mH, I<sub>AS</sub>=72A., R<sub>G</sub>=25Ω, Starting T<sub>J</sub>=25°C.
3. The data tested by pulsed , pulse width ≤ 300us , duty cycle ≤ 2%.
4. Essentially independent of operating temperature.



**Fig.1 Typical Output Characteristics**



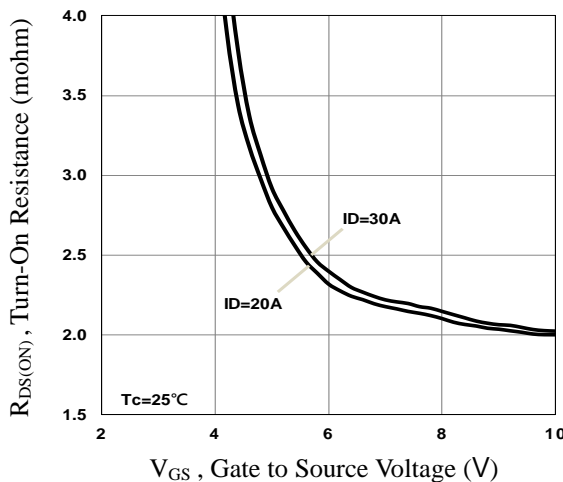
**Fig.2 Continuous Drain Current vs. T<sub>c</sub>**



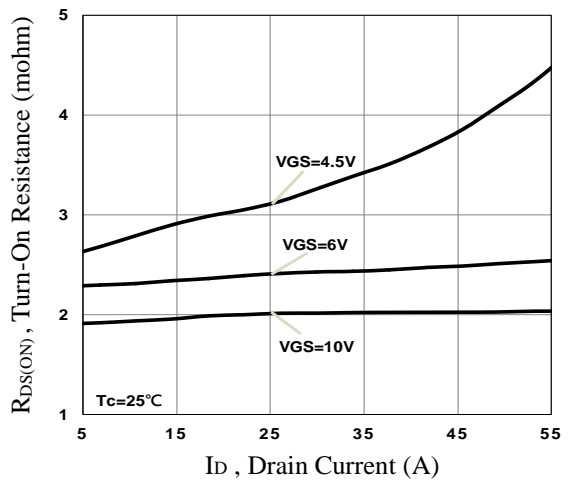
**Fig.3 Normalized R<sub>DS(on)</sub> vs. T<sub>j</sub>**



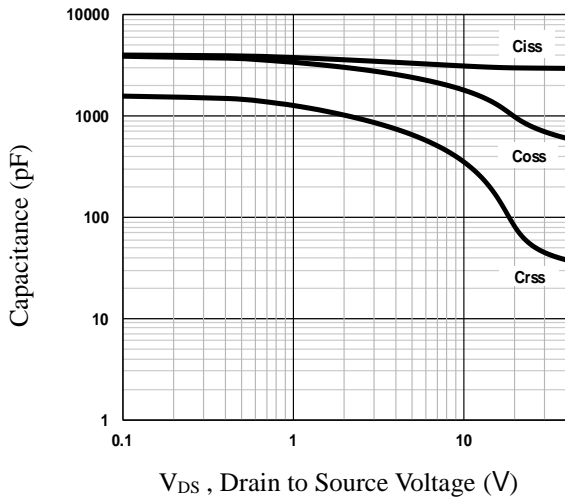
**Fig.4 Normalized V<sub>th</sub> vs. T<sub>j</sub>**



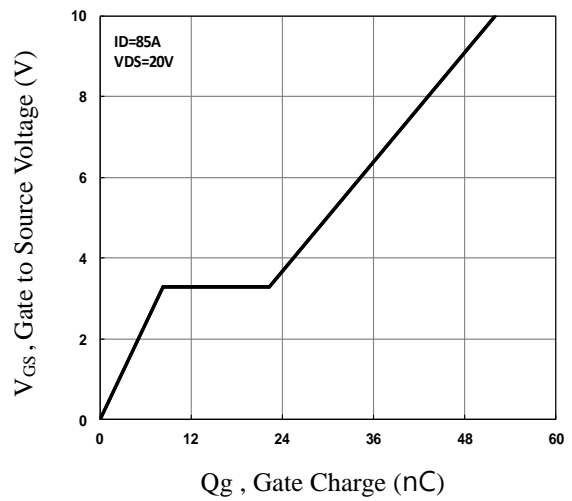
**Fig.5 Turn-On Resistance vs. V<sub>GS</sub>**



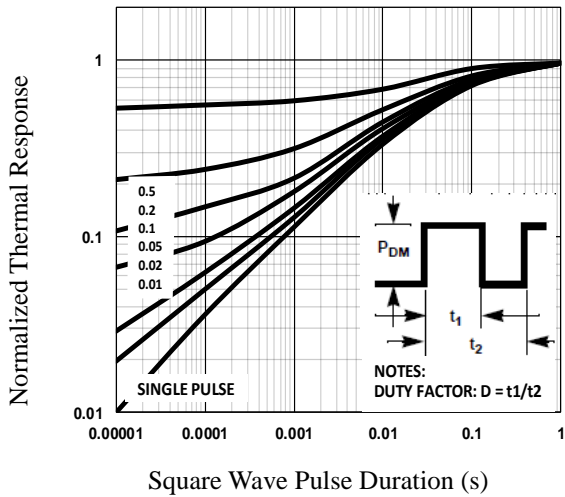
**Fig.6 Turn-On Resistance vs. I<sub>D</sub>**



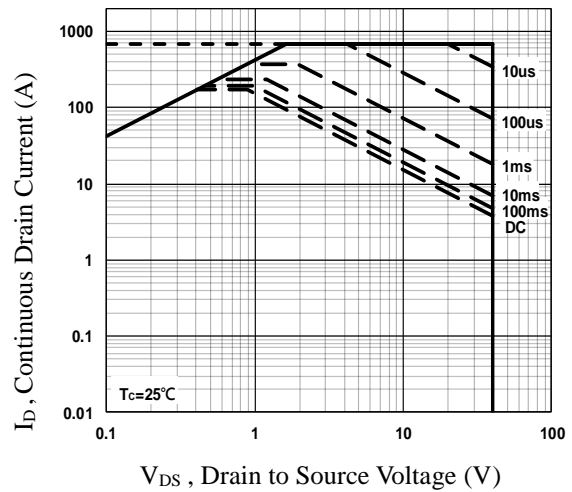
**Fig.7 Capacitance Characteristics**



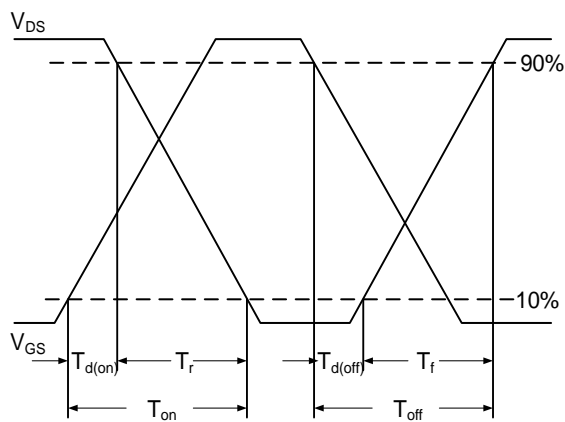
**Fig.8 Gate Charge Characteristics**



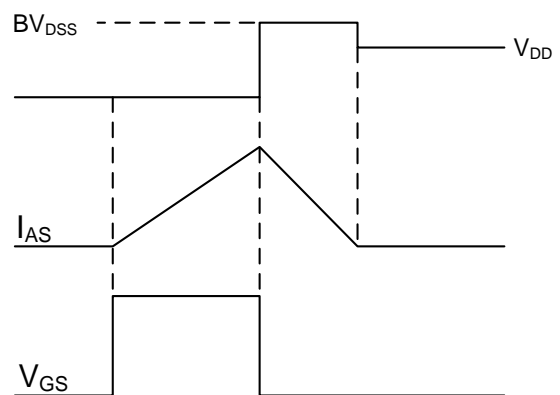
**Fig.9 Normalized Transient Impedance**



**Fig.10 Maximum Safe Operation Area**

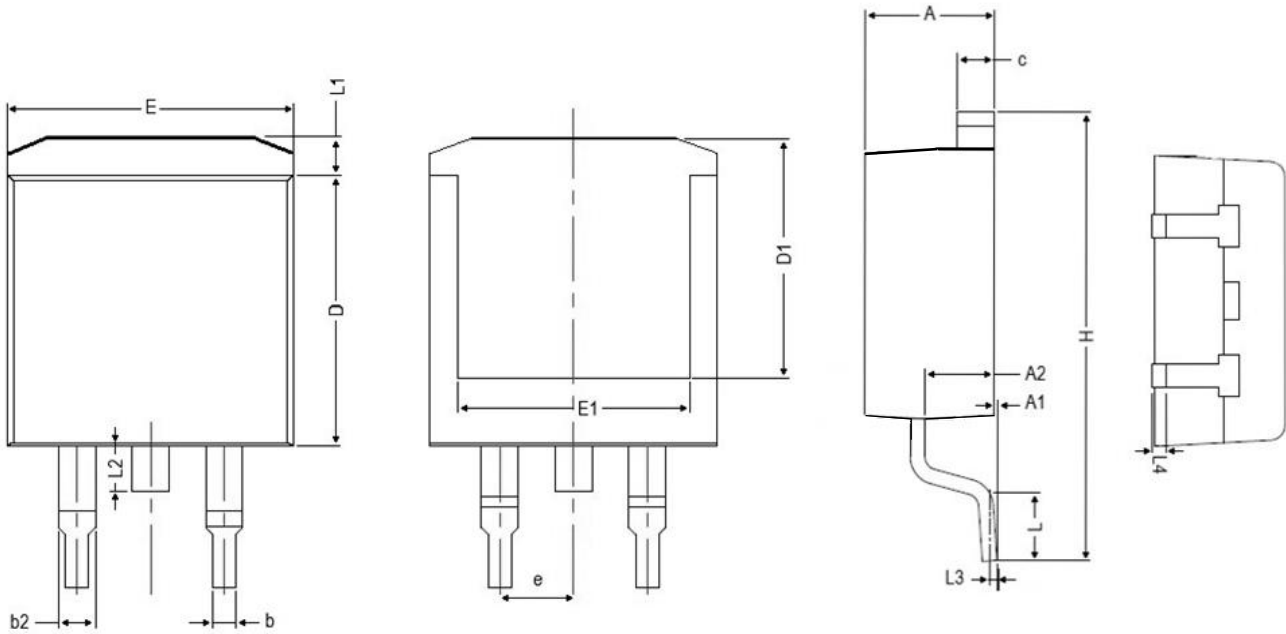


**Fig.11 Switching Time Waveform**



**Fig.12 EAS Waveform**

**TO263 PACKAGE INFORMATION**



Symbol	Dimensions In Millimeters		Dimensions In Inches	
	MAX	MIN	MAX	MIN
A	4.850	4.200	0.191	0.165
A1	0.300	0.000	0.012	0.000
A2	2.900	2.200	0.114	0.087
b	0.950	0.700	0.037	0.028
b2	1.700	1.000	0.067	0.039
c	1.450	1.150	0.057	0.045
D	9.500	8.350	0.374	0.329
D1	9.150	6.400	0.360	0.252
E	10.500	9.600	0.413	0.378
E1	8.900	6.850	0.350	0.270
e	2.540 BSC		0.100 BSC	
H	15.900	14.600	0.626	0.575
L	2.800	1.700	0.110	0.067
L1	1.700	1.050	0.067	0.041
L2	2.100	1.300	0.083	0.051
L3	0.250 BSC		0.010 BSC	
L4	0.750	0.200	0.030	0.008