

General Description

These N-Channel enhancement mode power field effect transistors are using trench DMOS technology. This advanced technology has been especially tailored to minimize on-state resistance, provide superior switching performance, and withstand high energy pulse in the avalanche and commutation mode. These devices are well suited for high efficiency fast switching applications.

| | | |
|-------|-------|------|
| BVDSS | RDSON | ID |
| 65V | 3.3mΩ | 150A |

Features

- 65V, 150A, $R_{DS(ON)} = 3.3m\Omega @ V_{GS} = 10V$
- Improved dv/dt capability
- Fast switching
- 100% EAS Guaranteed
- Green Device Available

TO263 Pin Configuration

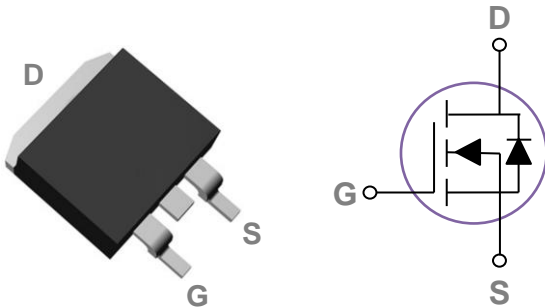

Applications

- Networking
- Load Switch
- LED applications
- Quick Charger

Absolute Maximum Ratings $T_c=25^\circ\text{C}$ unless otherwise noted

| Symbol | Parameter | Rating | Units |
|-----------|--|------------|---------------------|
| V_{DS} | Drain-Source Voltage | 65 | V |
| V_{GS} | Gate-Source Voltage | +20/-12 | V |
| I_D | Drain Current – Continuous ($T_c=25^\circ\text{C}$) | 150 | A |
| | Drain Current – Continuous ($T_c=100^\circ\text{C}$) | 94 | A |
| I_{DM} | Drain Current – Pulsed ¹ | 600 | A |
| EAS | Single Pulse Avalanche Energy ² | 460 | mJ |
| IAS | Single Pulse Avalanche Current ² | 96 | A |
| P_D | Power Dissipation ($T_c=25^\circ\text{C}$) | 183 | W |
| | Power Dissipation – Derate above 25°C | 1.47 | W/ $^\circ\text{C}$ |
| T_{STG} | Storage Temperature Range | -55 to 150 | $^\circ\text{C}$ |
| T_J | Operating Junction Temperature Range | -55 to 150 | $^\circ\text{C}$ |

Thermal Characteristics

| Symbol | Parameter | Typ. | Max. | Unit |
|-----------------|--|------|------|---------------------------|
| $R_{\theta JA}$ | Thermal Resistance Junction to ambient | --- | 62 | $^\circ\text{C}/\text{W}$ |
| $R_{\theta JC}$ | Thermal Resistance Junction to Case | --- | 0.68 | $^\circ\text{C}/\text{W}$ |

Electrical Characteristics (T_J=25 °C, unless otherwise noted)
Off Characteristics

| Symbol | Parameter | Conditions | Min. | Typ. | Max. | Unit |
|-------------------------------------|---|---|------|------|------|------|
| BV _{DSS} | Drain-Source Breakdown Voltage | V _{GS} =0V, I _D =250uA | 65 | --- | --- | V |
| ΔBV _{DSS} /ΔT _J | BV _{DSS} Temperature Coefficient | Reference to 25°C, I _D =1mA | --- | 0.05 | --- | V/°C |
| I _{DSS} | Drain-Source Leakage Current | V _{DS} =60V, V _{GS} =0V, T _J =25°C | --- | --- | 1 | uA |
| | | V _{DS} =48V, V _{GS} =0V, T _J =85°C | --- | --- | 10 | uA |
| I _{GSS} | Gate-Source Leakage Current | V _{GS} =20V, V _{DS} =0V | --- | --- | 100 | nA |

On Characteristics

| | | | | | | |
|----------------------|---|--|-----|-----|-----|-------|
| R _{DS(ON)} | Static Drain-Source On-Resistance | V _{GS} =10V, I _D =20A | --- | 2.7 | 3.3 | mΩ |
| | | V _{GS} =4.5V, I _D =10A | --- | 4.2 | 5.4 | mΩ |
| V _{GS(th)} | Gate Threshold Voltage | V _{GS} =V _{DS} , I _D =250uA | 1.2 | 1.6 | 2.5 | V |
| ΔV _{GS(th)} | V _{GS(th)} Temperature Coefficient | | --- | -5 | --- | mV/°C |
| g _{fs} | Forward Transconductance | V _{DS} =10V, I _D =5A | --- | 11 | --- | S |

Dynamic and switching Characteristics

| | | | | | | |
|---------------------|-------------------------------------|--|--|------|------|----|
| Q _g | Total Gate Charge ^{3, 4} | V _{DS} =48V, V _{GS} =10V, I _D =10A | --- | 59 | 120 | nC |
| Q _{gs} | Gate-Source Charge ^{3, 4} | | --- | 10.4 | 20 | |
| Q _{gd} | Gate-Drain Charge ^{3, 4} | | --- | 19.6 | 38 | |
| T _{d(on)} | Turn-On Delay Time ^{3, 4} | V _{DD} =30V, V _{GS} =10V, R _G =6Ω I _D =1A | --- | 22 | 44 | ns |
| T _r | Rise Time ^{3, 4} | | --- | 14 | 28 | |
| T _{d(off)} | Turn-Off Delay Time ^{3, 4} | | --- | 40 | 80 | |
| T _f | Fall Time ^{3, 4} | | --- | 20 | 40 | |
| C _{iss} | Input Capacitance | V _{DS} =25V, V _{GS} =0V, F=1MHz | --- | 4780 | 9500 | pF |
| C _{oss} | Output Capacitance | | --- | 1365 | 2700 | |
| C _{rss} | Reverse Transfer Capacitance | | --- | 51 | 102 | |
| R _g | Gate resistance | | V _{GS} =0V, V _{DS} =0V, F=1MHz | --- | 1.8 | |

Drain-Source Diode Characteristics and Maximum Ratings

| Symbol | Parameter | Conditions | Min. | Typ. | Max. | Unit |
|-----------------|---------------------------|---|------|------|------|------|
| I _S | Continuous Source Current | V _G =V _D =0V, Force Current | --- | --- | 150 | A |
| I _{SM} | Pulsed Source Current | | --- | --- | 300 | A |
| V _{SD} | Diode Forward Voltage | V _{GS} =0V, I _S =1A, T _J =25°C | --- | --- | 1 | V |
| t _{rr} | Reverse Recovery Time | V _R =50V, I _S =10A | --- | 70 | --- | ns |
| Q _{rr} | Reverse Recovery Charge | di/dt=100A/μs, T _J =25°C | --- | 140 | --- | nC |

Note :

1. Repetitive Rating : Pulsed width limited by maximum junction temperature.
2. V_{DD}=50V, V_{GS}=10V, L=0.1mH, I_{AS}=96A., R_G=25Ω, Starting T_J=25°C.
3. The data tested by pulsed, pulse width ≤ 300us, duty cycle ≤ 2%.
4. Essentially independent of operating temperature.

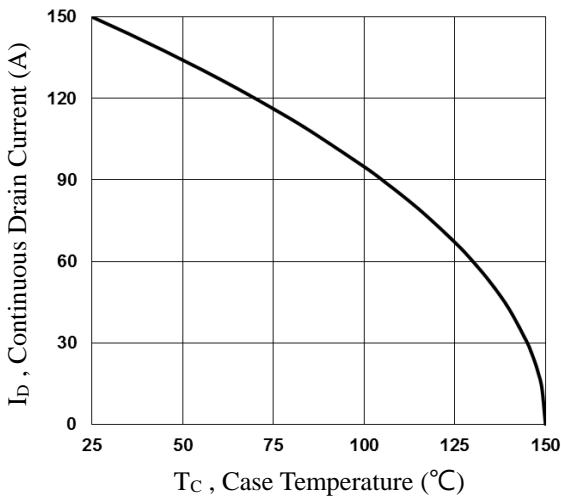

Fig.1 Continuous Drain Current vs. T_c

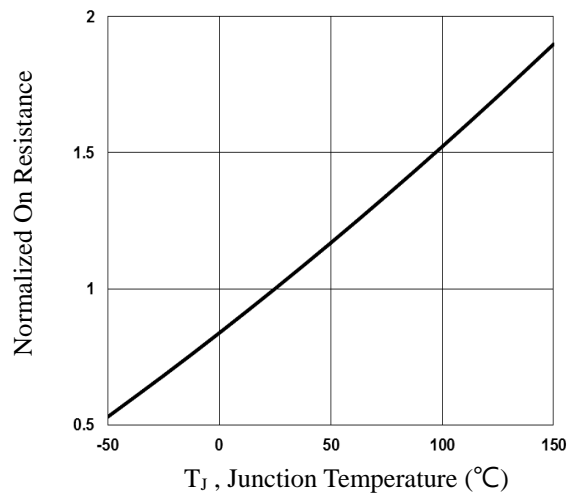

Fig.2 Normalized $R_{DS(on)}$ vs. T_j

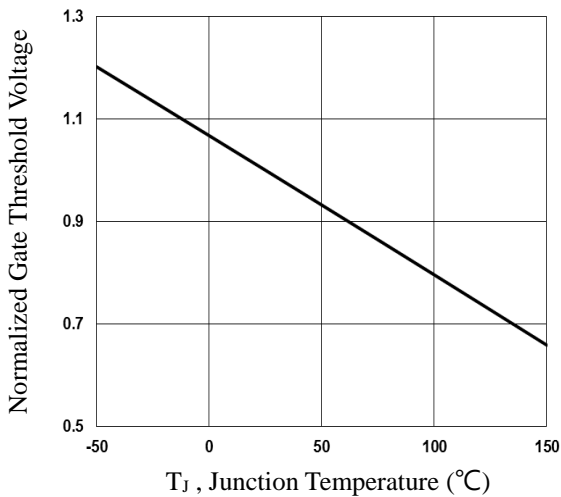

Fig.3 Normalized V_{th} vs. T_j

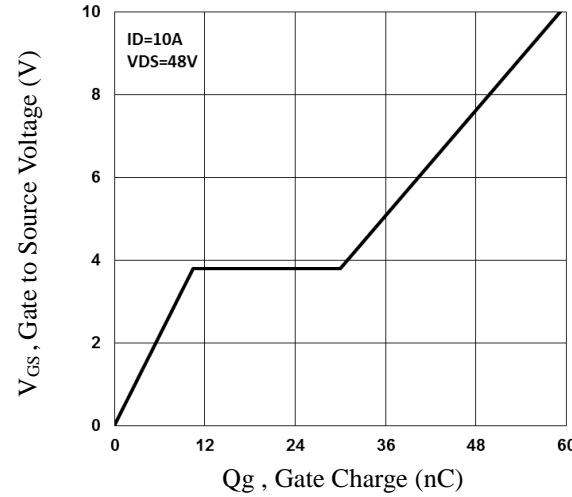

Fig.4 Gate Charge Characteristics

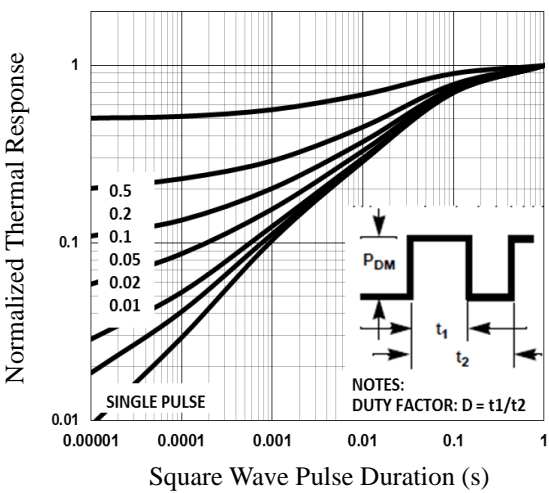

Fig.5 Normalized Transient Impedance

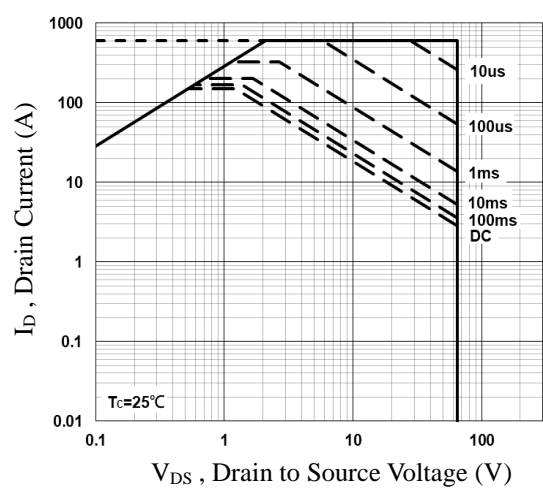

Fig.6 Maximum Safe Operation Area

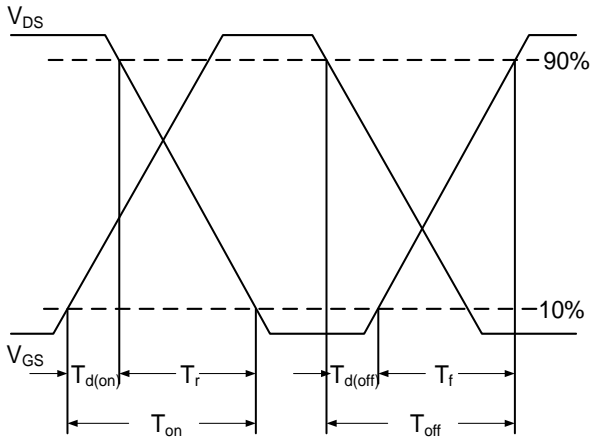
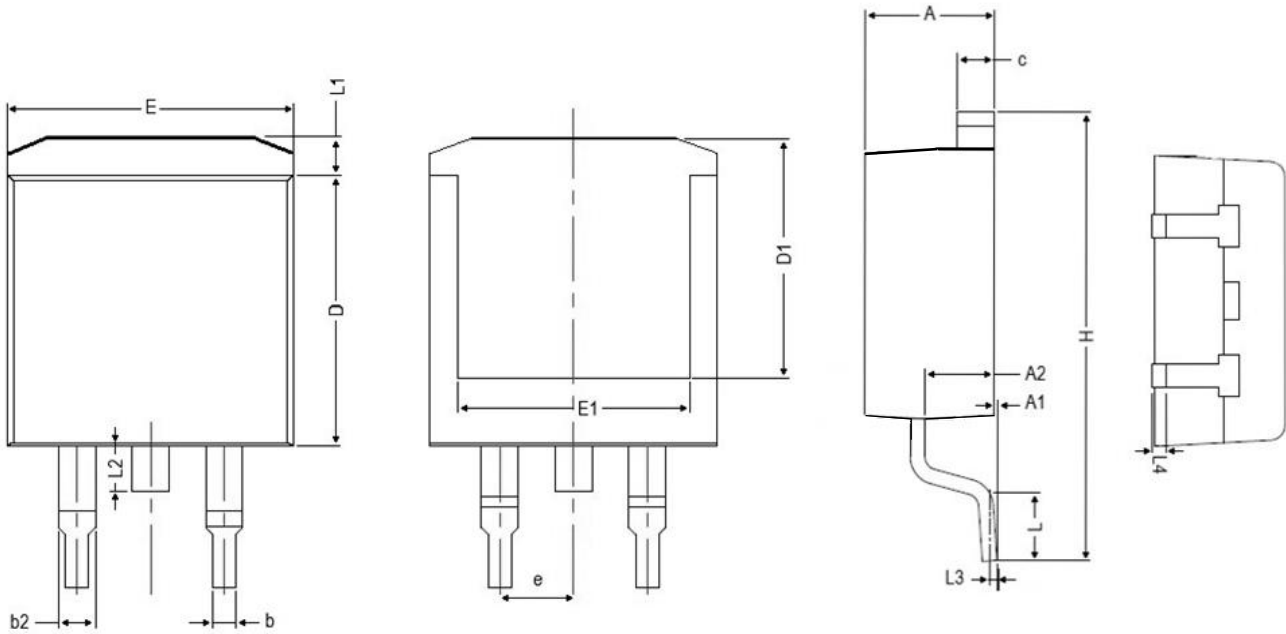

Fig.7 Switching Time Waveform



Fig.8 Gate Charge Waveform

TO263 PACKAGE INFORMATION



| Symbol | Dimensions In Millimeters | | Dimensions In Inches | |
|--------|---------------------------|--------|----------------------|-------|
| | MAX | MIN | MAX | MIN |
| A | 4.850 | 4.200 | 0.191 | 0.165 |
| A1 | 0.300 | 0.000 | 0.012 | 0.000 |
| A2 | 2.900 | 2.200 | 0.114 | 0.087 |
| b | 0.950 | 0.700 | 0.037 | 0.028 |
| b2 | 1.700 | 1.000 | 0.067 | 0.039 |
| c | 1.450 | 1.150 | 0.057 | 0.045 |
| D | 9.500 | 8.350 | 0.374 | 0.329 |
| D1 | 9.150 | 6.400 | 0.360 | 0.252 |
| E | 10.500 | 9.600 | 0.413 | 0.378 |
| E1 | 8.900 | 6.850 | 0.350 | 0.270 |
| e | 2.540 BSC | | 0.100 BSC | |
| H | 15.900 | 14.600 | 0.626 | 0.575 |
| L | 2.800 | 1.700 | 0.110 | 0.067 |
| L1 | 1.700 | 1.050 | 0.067 | 0.041 |
| L2 | 2.100 | 1.300 | 0.083 | 0.051 |
| L3 | 0.250 BSC | | 0.010 BSC | |
| L4 | 0.750 | 0.200 | 0.030 | 0.008 |