

General Description

These N-Channel enhancement mode power field effect transistors are using trench DMOS technology. This advanced technology has been especially tailored to minimize on-state resistance, provide superior switching performance, and withstand high energy pulse in the avalanche and commutation mode. These devices are well suited for high efficiency fast switching applications.

BVDSS	RDSON	ID
100V	3.5mΩ	160A

Features

- 100V, 160A, $R_{DS(ON)} = 3.5m\Omega @ V_{GS} = 10V$
- Improved dv/dt capability
- Fast switching
- Green Device Available

TO263 Pin Configuration

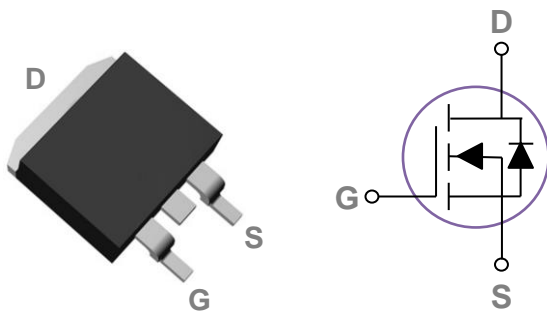

Applications

- Networking
- Load Switch
- LED applications
- Quick Charger

Absolute Maximum Ratings $T_c=25^\circ\text{C}$ unless otherwise noted

Symbol	Parameter	Rating	Units
V_{DS}	Drain-Source Voltage	100	V
V_{GS}	Gate-Source Voltage	+20/-12	V
I_D	Drain Current – Continuous ($T_c=25^\circ\text{C}$)	160	A
	Drain Current – Continuous ($T_c=100^\circ\text{C}$)	101	A
I_{DM}	Drain Current – Pulsed ¹	640	A
EAS	Single Pulse Avalanche Energy ²	1625	mJ
IAS	Single Pulse Avalanche Current ²	57	A
P_D	Power Dissipation ($T_c=25^\circ\text{C}$)	230	W
	Power Dissipation – Derate above 25°C	1.84	W/ $^\circ\text{C}$
T_{STG}	Storage Temperature Range	-55 to 150	$^\circ\text{C}$
T_J	Operating Junction Temperature Range	-55 to 150	$^\circ\text{C}$

Thermal Characteristics

Symbol	Parameter	Typ.	Max.	Unit
$R_{\theta JA}$	Thermal Resistance Junction to ambient	---	62	$^\circ\text{C/W}$
$R_{\theta JC}$	Thermal Resistance Junction to Case	---	0.54	$^\circ\text{C/W}$

Electrical Characteristics (T_J=25 °C, unless otherwise noted)
Off Characteristics

Symbol	Parameter	Conditions	Min.	Typ.	Max.	Unit
BV _{DSS}	Drain-Source Breakdown Voltage	V _{GS} =0V , I _D =250uA	100	---	---	V
I _{DSS}	Drain-Source Leakage Current	V _{DS} =100V , V _{GS} =0V , T _J =25°C	---	---	1	uA
		V _{DS} =80V , V _{GS} =0V , T _J =85°C	---	---	10	uA
I _{GSS}	Gate-Source Leakage Current	V _{GS} =20V , V _{DS} =0V	---	---	100	nA

On Characteristics

R _{DS(ON)}	Static Drain-Source On-Resistance	V _{GS} =10V , I _D =20A	---	2.9	3.5	mΩ
V _{GS(th)}	Gate Threshold Voltage	V _{GS} =V _{DS} , I _D =250uA	2	2.6	4	V
g _{fs}	Forward Transconductance	V _{DS} =10V , I _D =3A	---	14	---	S

Dynamic and switching Characteristics

Q _g	Total Gate Charge ^{2, 3}	V _{DS} =50V , V _{GS} =10V , I _D =80A	---	120	180	nC
Q _{gs}	Gate-Source Charge ^{2, 3}		---	26	39	
Q _{gd}	Gate-Drain Charge ^{2, 3}		---	40	60	
T _{d(on)}	Turn-On Delay Time ^{2, 3}	V _{DD} =50V , V _{GS} =10V , R _G =6Ω I _D =80A	---	17	26	ns
T _r	Rise Time ^{2, 3}		---	18	27	
T _{d(off)}	Turn-Off Delay Time ^{2, 3}		---	76	114	
T _f	Fall Time ^{2, 3}		---	84	126	
C _{iss}	Input Capacitance	V _{DS} =50V , V _{GS} =0V , F=1MHz	---	6880	10320	pF
C _{oss}	Output Capacitance		---	1460	2190	
C _{rss}	Reverse Transfer Capacitance		---	25	38	
R _g	Gate resistance	V _{GS} =0V , V _{DS} =0V , F=1MHz	---	0.9	---	Ω

Drain-Source Diode Characteristics and Maximum Ratings

Symbol	Parameter	Conditions	Min.	Typ.	Max.	Unit
I _S	Continuous Source Current	V _G =V _D =0V , Force Current	---	---	160	A
I _{SM}	Pulsed Source Current		---	---	320	A
V _{SD}	Diode Forward Voltage	V _{GS} =0V , I _S =1A , T _J =25°C	---	---	1	V
t _{rr}	Reverse Recovery Time	V _R =100V , I _S =10A ,	---	150	---	ns
Q _{rr}	Reverse Recovery Charge	di/dt=100A/μs , T _J =25°C	---	450	---	nC

Note :

1. Repetitive Rating : Pulsed width limited by maximum junction temperature.
2. V_{DD}=25V, V_{GS}=10V, L=1mH, I_{AS}=57A., R_G=25Ω, Starting T_J=25°C.
3. The data tested by pulsed , pulse width ≤ 300us , duty cycle ≤ 2%.
4. Essentially independent of operating temperature.

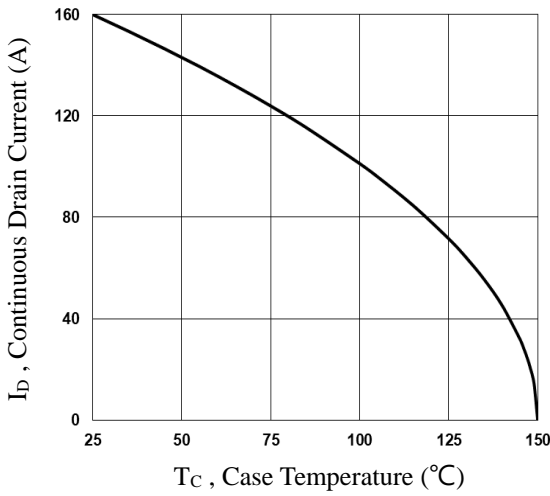

Fig.1 Continuous Drain Current vs. T_c

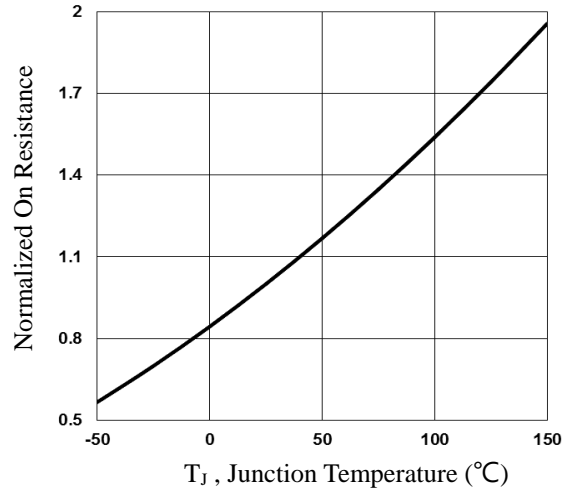

Fig.2 Normalized $R_{DS(on)}$ vs. T_j

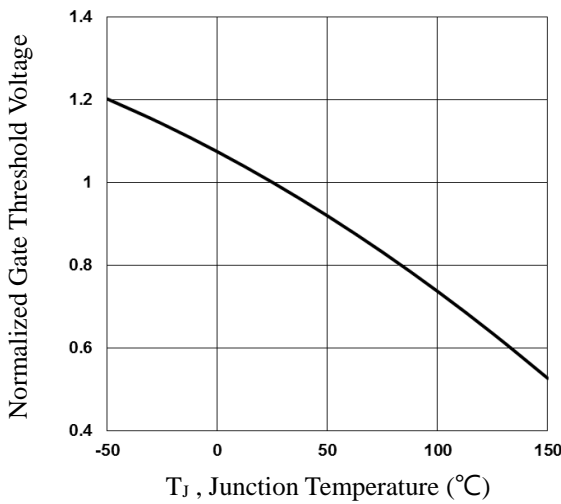

Fig.3 Normalized V_{th} vs. T_j

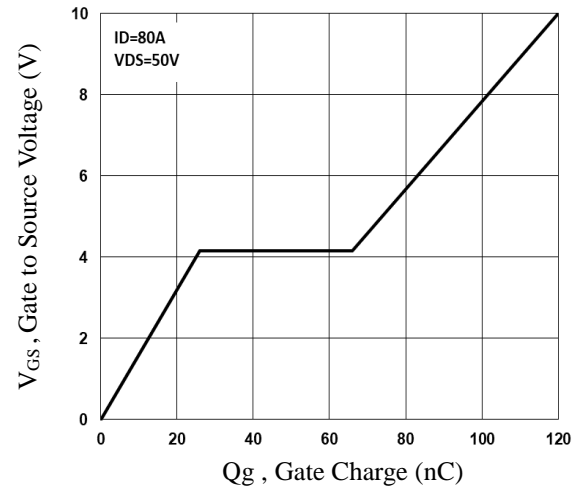

Fig.4 Gate Charge Characteristics

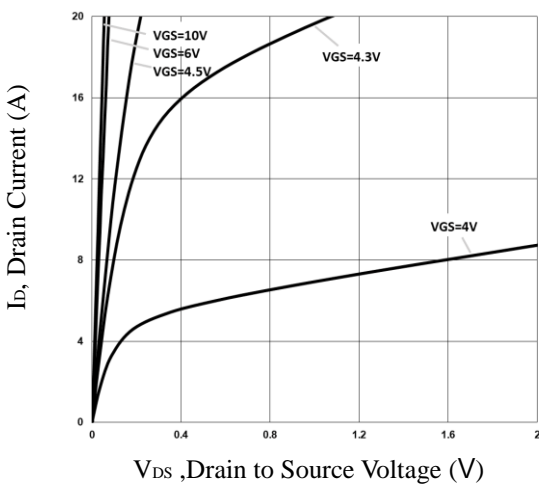

Fig.5 Typical Output Characteristics

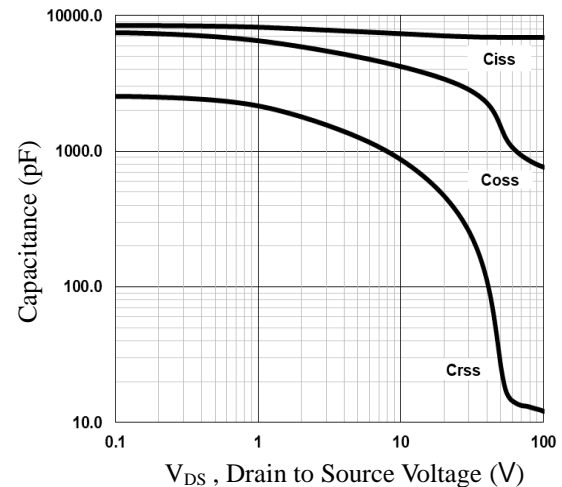

Fig.6 Capacitance Characteristics

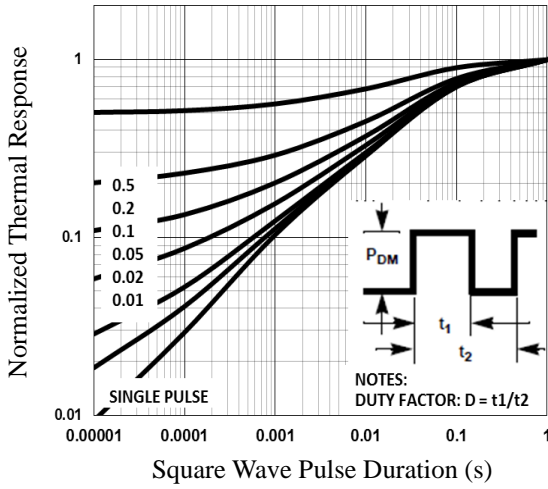

Fig.7 Normalized Transient Impedance

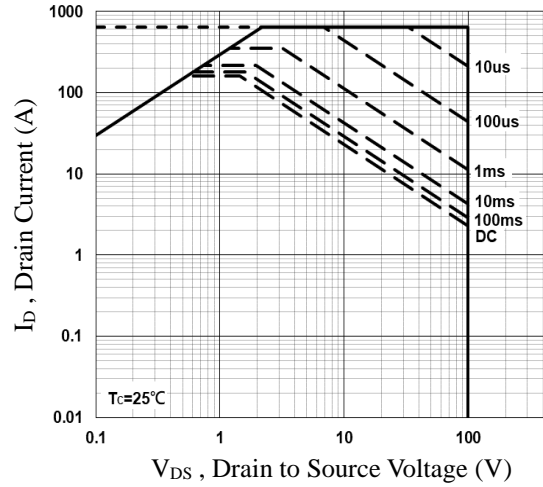

Fig.8 Maximum Safe Operation Area

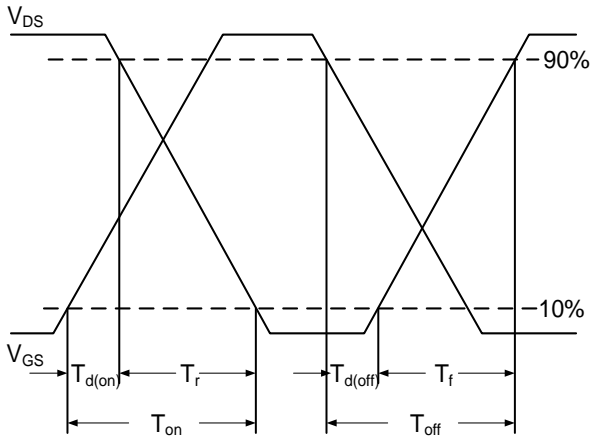

Fig.9 Switching Time Waveform

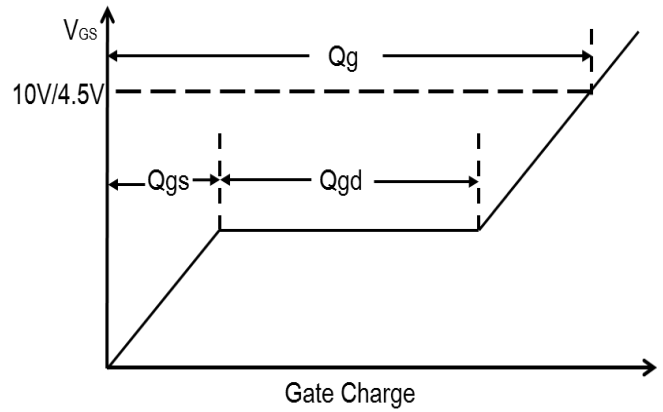
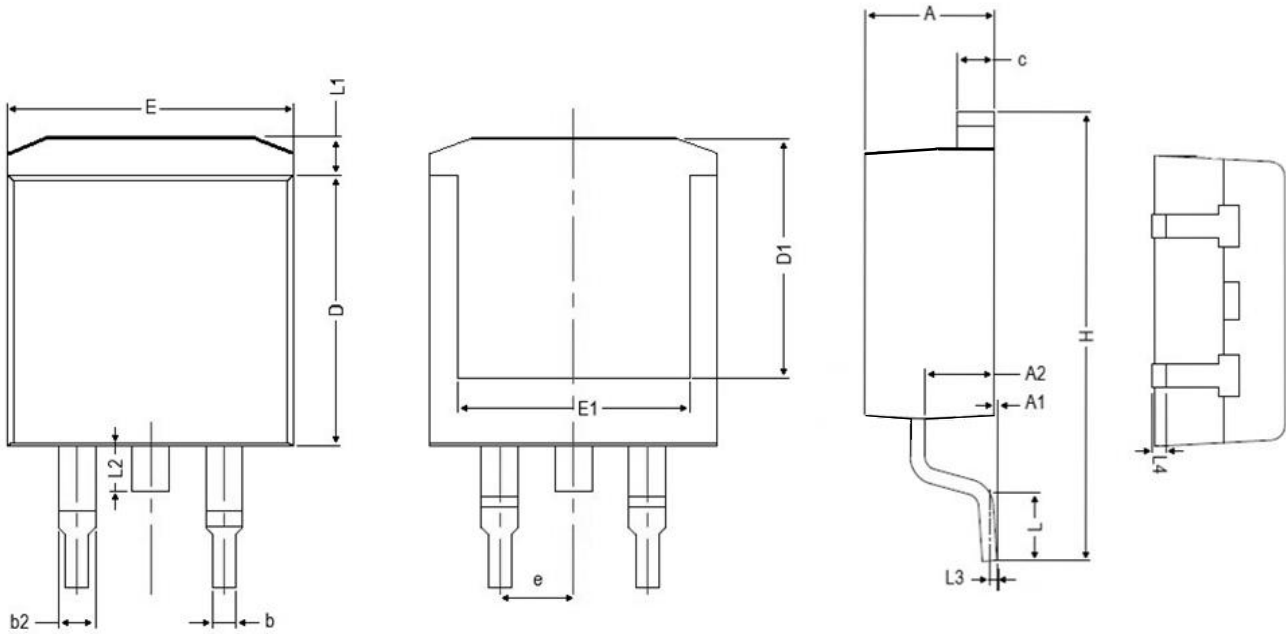

Fig.10 Gate Charge Waveform

TO263 PACKAGE INFORMATION



Symbol	Dimensions In Millimeters		Dimensions In Inches	
	MAX	MIN	MAX	MIN
A	4.850	4.200	0.191	0.165
A1	0.300	0.000	0.012	0.000
A2	2.900	2.200	0.114	0.087
b	0.950	0.700	0.037	0.028
b2	1.700	1.000	0.067	0.039
c	1.450	1.150	0.057	0.045
D	9.500	8.350	0.374	0.329
D1	9.150	6.400	0.360	0.252
E	10.500	9.600	0.413	0.378
E1	8.900	6.850	0.350	0.270
e	2.540 BSC		0.100 BSC	
H	15.900	14.600	0.626	0.575
L	2.800	1.700	0.110	0.067
L1	1.700	1.050	0.067	0.041
L2	2.100	1.300	0.083	0.051
L3	0.250 BSC		0.010 BSC	
L4	0.750	0.200	0.030	0.008