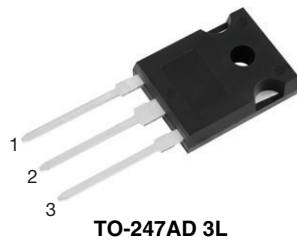
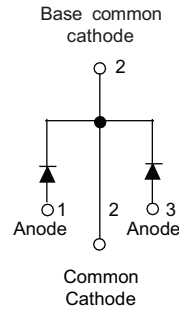

# 650 V Power SiC Gen 3 Merged PIN Schottky Diode, 2 x 8 A

**TO-247AD 3L**

**FEATURES**

- Majority carrier diode using Schottky technology on SiC wide band gap material
- Improved  $V_F$  and efficiency by thin wafer technology
- Positive  $V_F$  temperature coefficient, for easy paralleling
- Virtually no recovery tail and no switching losses
- Temperature invariant switching behavior
- 175 °C maximum operating junction temperature
- MPS structure for high ruggedness to forward current surge events
- Meets JESD 201 class 1A whisker test
- Solder Bath temperature 275 °C maximum, 10 s per JESD 22-B106
- Material categorization: for definitions of compliance please see [www.vishay.com/doc?99912](http://www.vishay.com/doc?99912)

**RoHS COMPLIANT**  
 HALOGEN FREE

**LINKS TO ADDITIONAL RESOURCES**

PRIMARY CHARACTERISTICS	
$I_{F(AV)}$	2 x 8 A
$V_R$	650 V
$V_F$ at $I_F$ at 150 °C	1.5 V
$T_J$ max.	175 °C
$I_R$ at $V_R$ at 175 °C	1.9 $\mu$ A
$Q_C$ ( $V_R = 400$ V)	22 nC
Package	TO-247AD 3L
Circuit configuration	Common cathode

**DESCRIPTION / APPLICATIONS**

Wide band gap SiC based 650 V Schottky diode, designed for high performance and ruggedness.

Optimum choice for high speed hard switching and efficient operation over a wide temperature range, it is also recommended for all applications suffering from Silicon ultrafast recovery behavior.

Typical applications include AC/DC PFC and DC/DC ultra high frequency output rectification in FBPS and LLC converters.

**MECHANICAL DATA**

**Case:** TO-247AD 3L

Molding compound meets UL 94 V-0 flammability rating  
 Base P/N-M3 - halogen-free, RoHS-compliant

**Terminals:** matte tin plated leads, solderable per J-STD-002 and JESD 22-B102

**Mounting torque:** 10 in-lbs maximum

ABSOLUTE MAXIMUM RATINGS ( $T_A = 25$ °C unless otherwise specified)				
PARAMETER	SYMBOL	TEST CONDITIONS	VALUES	UNITS
Peak repetitive reverse voltage	$V_{RRM}$		650	V
Average rectified forward current, per leg	$I_{F(AV)}$	$T_C = 135$ °C (DC)	8	A
DC blocking voltage	$V_{DC}$		650	V
Repetitive peak forward current	$I_{FRM}$	$T_C = 25$ °C, $f = 50$ Hz, square wave, DC = 25 %	35	A
Non-repetitive peak forward surge current, per leg	$I_{FSM}$	$T_C = 25$ °C, $t_p = 10$ ms, half sine wave	54	
		$T_C = 110$ °C, $t_p = 10$ ms, half sine wave	52	
Power dissipation, per leg	$P_{tot}^{(1)}$	$T_C = 25$ °C	58	W
		$T_C = 110$ °C	25	
$I^2t$ value, per leg	$\int i^2 dt$	$T_C = 25$ °C	13.5	A <sup>2</sup> s
		$T_C = 110$ °C	12.5	
Operating junction and storage temperatures	$T_J^{(2)}, T_{Stg}$		-55 to +175	°C

**Notes**

(1) Based on maximum  $R_{th}$

(2) The heat generated must be less than the thermal conductivity from junction-to-ambient:  $dP_D/dT_J < 1/R_{\theta JA}$



<b>ELECTRICAL SPECIFICATIONS</b> ( $T_J = 25\text{ }^\circ\text{C}$ unless otherwise specified)						
PARAMETER	SYMBOL	TEST CONDITIONS	MIN.	TYP.	MAX.	UNITS
Forward voltage, per leg	$V_F$	$I_F = 8\text{ A}$	-	1.3	1.5	V
		$I_F = 8\text{ A}, T_J = 150\text{ }^\circ\text{C}$	-	1.5	1.8	
		$I_F = 8\text{ A}, T_J = 175\text{ }^\circ\text{C}$	-	1.58	-	
Reverse leakage current, per leg	$I_R$	$V_R = V_R\text{ rated}$	-	0.25	45	$\mu\text{A}$
		$V_R = V_R\text{ rated}, T_J = 150\text{ }^\circ\text{C}$	-	1.1	100	
		$V_R = V_R\text{ rated}, T_J = 175\text{ }^\circ\text{C}$	-	1.9	-	
Total capacitance, per leg	C	$V_R = 1\text{ V}, f = 1\text{ MHz}$	-	340	-	pF
		$V_R = 400\text{ V}, f = 1\text{ MHz}$	-	34	-	
Total capacitive charge, per leg	$Q_C$	$V_R = 400\text{ V}, f = 1\text{ MHz}$	-	22	-	nC

<b>THERMAL - MECHANICAL SPECIFICATIONS</b> ( $T_A = 25\text{ }^\circ\text{C}$ unless otherwise specified)							
PARAMETER		SYMBOL	TEST CONDITIONS	MIN.	TYP.	MAX.	UNITS
Thermal resistance, junction-to-case	per leg	$R_{thJC}$		-	2.0	2.6	$^\circ\text{C/W}$
	per device			-	1.0	1.3	$^\circ\text{C/W}$
Marking device				3C16CP07L			

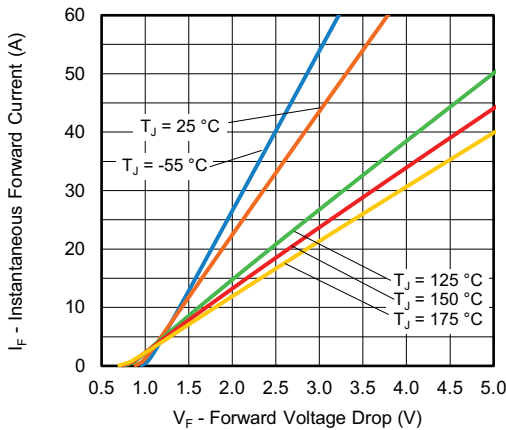

Fig. 1 - Typical Forward Voltage Drop Characteristics, Per Leg

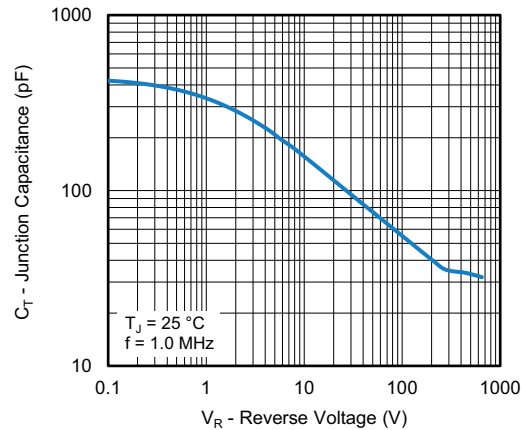

Fig. 3 - Typical Junction Capacitance vs. Reverse Voltage, Per Leg

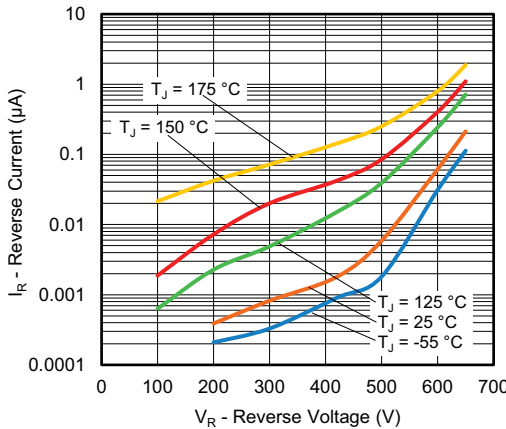

Fig. 2 - Typical Values of Reverse Current vs. Reverse Voltage, Per Leg

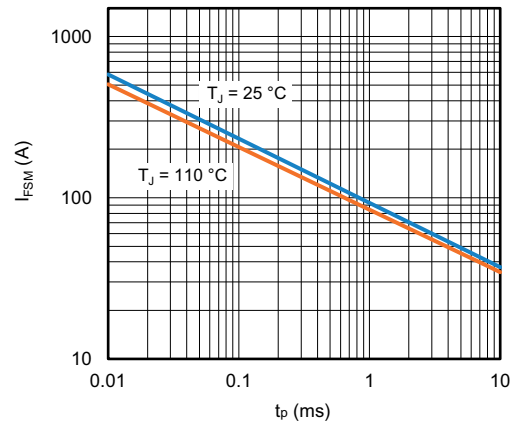

Fig. 4 - Non-Repetitive Peak Forward Surge Current vs. Pulse Duration, Per Leg (Square Wave)

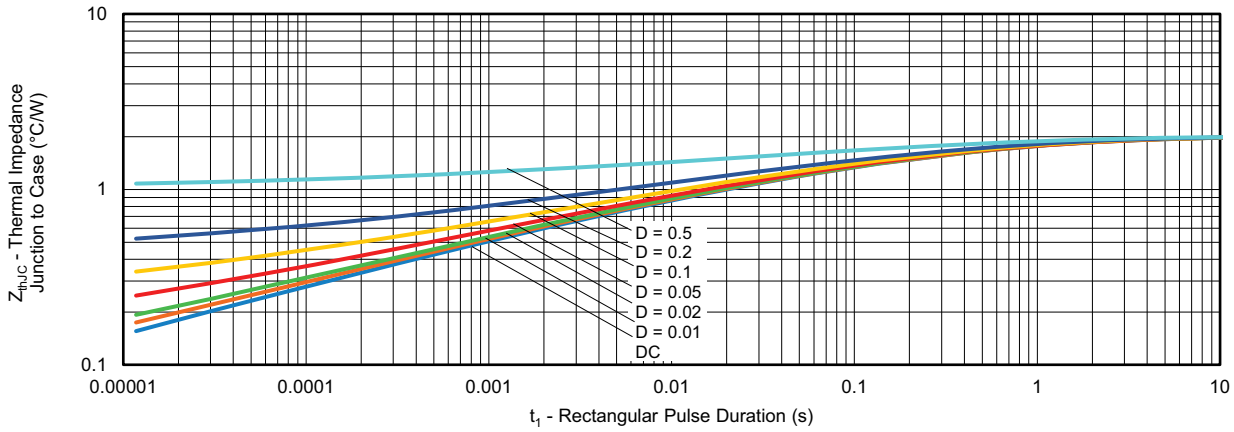

Fig. 5 - Typical Thermal Impedance  $Z_{thJC}$  Characteristics, Per Leg

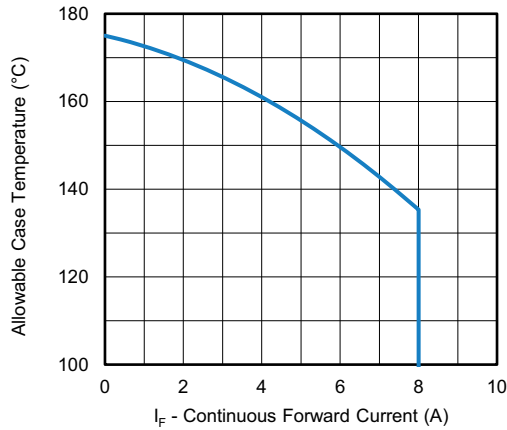

Fig. 6 - Maximum Allowable Case Temperature vs. Average Forward Current, Per Leg

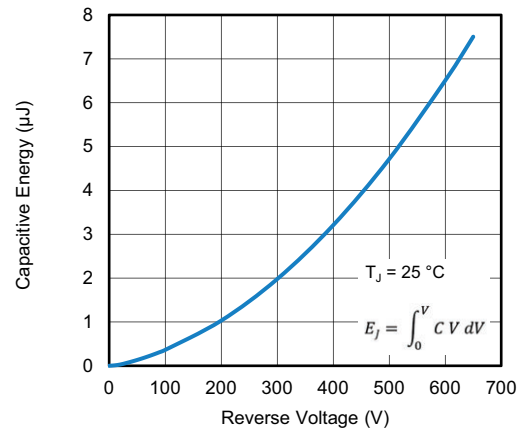

Fig. 8 - Typical Capacitive Energy vs. Reverse Voltage, Per Leg

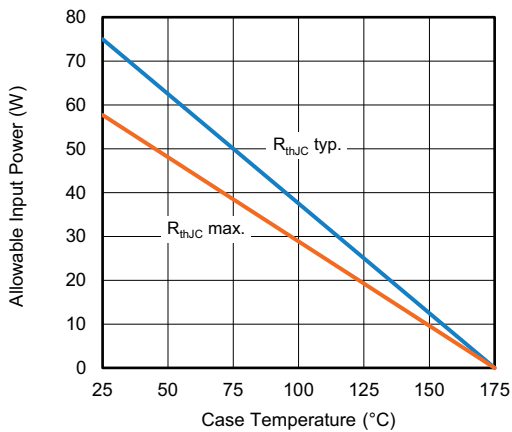

Fig. 7 - Forward Power Loss Characteristics, Per Leg

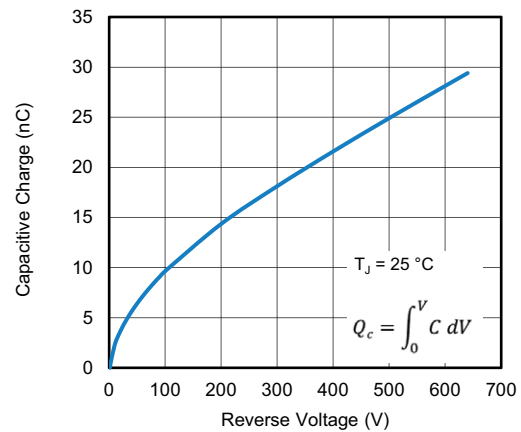
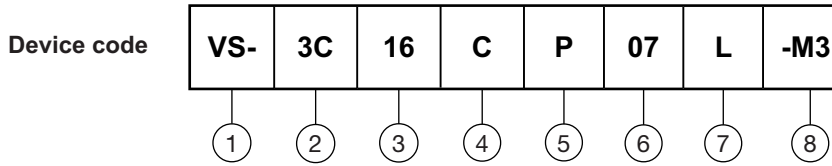

Fig. 9 - Typical Capacitive Charge vs. Reverse Voltage, Per Leg



ORDERING INFORMATION TABLE



- 1** - Vishay Semiconductors product
- 2** - 3C = SiC diode, Generation 3
- 3** - Current rating (16 = 16 A)
- 4** - C = common cathode
- 5** - P = package TO-247
- 6** - Voltage rating: (07 = 650 V)
- 7** - L = long lead
- 8** - Environmental digit:  
-M3 = halogen-free, RoHS-compliant, and termination lead (Pb)-free

ORDERING INFORMATION		
PREFERRED P/N	BASE QUANTITY	PACKAGING DESCRIPTION
VS-3C16CP07L-M3	25/tube	Antistatic plastic tubes

LINKS TO RELATED DOCUMENTS	
Dimensions	<a href="http://www.vishay.com/doc?95626">www.vishay.com/doc?95626</a>
Part marking information	<a href="http://www.vishay.com/doc?95007">www.vishay.com/doc?95007</a>

### TO-247AD 3L

**DIMENSIONS** in millimeters and inches

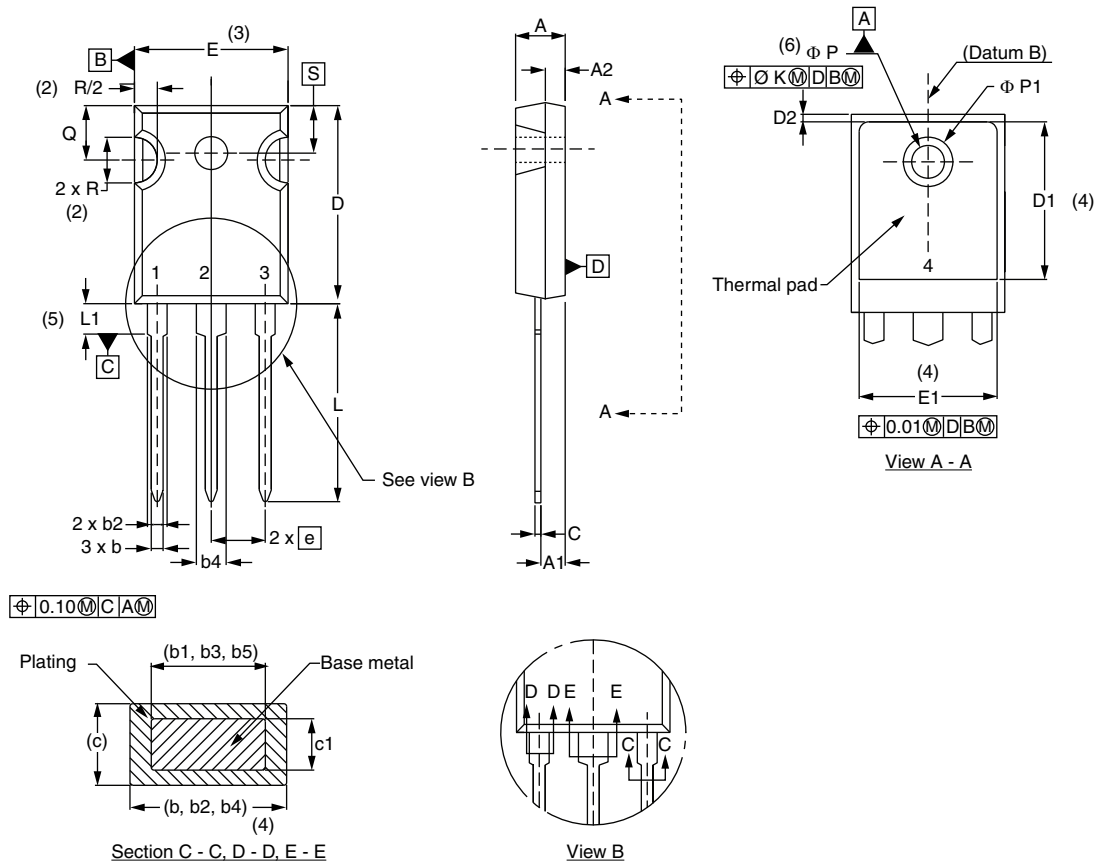

SYMBOL	MILLIMETERS		INCHES		NOTES	SYMBOL	MILLIMETERS		INCHES		NOTES
	MIN.	MAX.	MIN.	MAX.			MIN.	MAX.	MIN.	MAX.	
A	4.65	5.31	0.183	0.209		D2	0.51	1.30	0.020	0.051	
A1	2.21	2.59	0.087	0.102		E	15.29	15.87	0.602	0.625	3
A2	1.50	2.49	0.059	0.098		E1	13.46	-	0.53	-	
b	0.99	1.40	0.039	0.055		e	5.46 BSC		0.215 BSC		
b1	0.99	1.35	0.039	0.053		Ø K	0.254		0.010		
b2	1.65	2.39	0.065	0.094		L	19.81	20.32	0.780	0.800	
b3	1.65	2.34	0.065	0.092		L1	3.71	4.29	0.146	0.169	
b4	2.59	3.43	0.102	0.135		Ø P	3.56	3.66	0.14	0.144	
b5	2.59	3.38	0.102	0.133		Ø P1	-	6.98	-	0.275	
c	0.38	0.89	0.015	0.035		Q	5.31	5.69	0.209	0.224	
c1	0.38	0.84	0.015	0.033		R	4.52	5.49	0.178	0.216	
D	19.71	20.70	0.776	0.815	3	S	5.51 BSC		0.217 BSC		
D1	13.08	-	0.515	-	4						

**Notes**

- (1) Dimensioning and tolerancing per ASME Y14.5M-1994
- (2) Contour of slot optional
- (3) Dimension D and E do not include mold flash. These dimensions are measured at the outermost extremes of the plastic body
- (4) Thermal pad contour optional with dimensions D1 and E1
- (5) Lead finish uncontrolled in L1
- (6) Ø P to have a maximum draft angle of 1.5 to the top of the part with a maximum hole diameter of 3.91 mm (0.154")
- (7) Outline conforms to JEDEC® outline TO-247 with exception of dimension A min., D, E min., Q min., S, and note 4



## Disclaimer

ALL PRODUCT, PRODUCT SPECIFICATIONS AND DATA ARE SUBJECT TO CHANGE WITHOUT NOTICE TO IMPROVE RELIABILITY, FUNCTION OR DESIGN OR OTHERWISE.

Vishay Intertechnology, Inc., its affiliates, agents, and employees, and all persons acting on its or their behalf (collectively, "Vishay"), disclaim any and all liability for any errors, inaccuracies or incompleteness contained in any datasheet or in any other disclosure relating to any product.

Vishay makes no warranty, representation or guarantee regarding the suitability of the products for any particular purpose or the continuing production of any product. To the maximum extent permitted by applicable law, Vishay disclaims (i) any and all liability arising out of the application or use of any product, (ii) any and all liability, including without limitation special, consequential or incidental damages, and (iii) any and all implied warranties, including warranties of fitness for particular purpose, non-infringement and merchantability.

Statements regarding the suitability of products for certain types of applications are based on Vishay's knowledge of typical requirements that are often placed on Vishay products in generic applications. Such statements are not binding statements about the suitability of products for a particular application. It is the customer's responsibility to validate that a particular product with the properties described in the product specification is suitable for use in a particular application. Parameters provided in datasheets and / or specifications may vary in different applications and performance may vary over time. All operating parameters, including typical parameters, must be validated for each customer application by the customer's technical experts. Product specifications do not expand or otherwise modify Vishay's terms and conditions of purchase, including but not limited to the warranty expressed therein.

Hyperlinks included in this datasheet may direct users to third-party websites. These links are provided as a convenience and for informational purposes only. Inclusion of these hyperlinks does not constitute an endorsement or an approval by Vishay of any of the products, services or opinions of the corporation, organization or individual associated with the third-party website. Vishay disclaims any and all liability and bears no responsibility for the accuracy, legality or content of the third-party website or for that of subsequent links.

Except as expressly indicated in writing, Vishay products are not designed for use in medical, life-saving, or life-sustaining applications or for any other application in which the failure of the Vishay product could result in personal injury or death. Customers using or selling Vishay products not expressly indicated for use in such applications do so at their own risk. Please contact authorized Vishay personnel to obtain written terms and conditions regarding products designed for such applications.

No license, express or implied, by estoppel or otherwise, to any intellectual property rights is granted by this document or by any conduct of Vishay. Product names and markings noted herein may be trademarks of their respective owners.