

AC FAN

80mm~280mm



NA12025



General Specification

Size: 120×120×25mm
 Airflow: 76~112m³/hr 45~66CFM
 Weight: 314g
 Noise: 31~42dBA
 Impeller: PBT Black
 Frame: Aluminum Alloy
 Terminals: 0.5mm
 Lead Wire: AWG#22
 Motor: Shaded Pole Induction Motor
 Operation Temperature: -10°C~+65°C

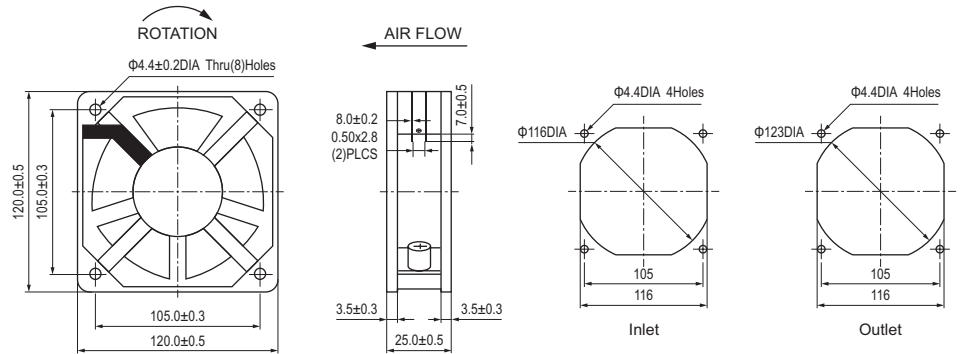

Specific Parameters

Model Number	Bearing Type	Voltage (V)	Freq. (Hz)	Current (A)	Power (W)	Speed (RPM)	Noise (dBA)	Air Flow		Phase	Capacitor
								M³/hr	CFM		
12025-110BH	Ball	100~125	50/60	0.25	21	2300/2700	39/42	96/112	57/66	1	/
12025-230BH	Ball	200~240	50/60	0.13	21	2300/2700	39/42	96/112	57/66	1	/
12025-110BM	Ball	100~125	50/60	0.16	16	1800/2300	31/36	76/95	45/56	1	/
12025-230BM	Ball	200~240	50/60	0.08	16	1800/2300	31/36	76/95	45/56	1	/
12025-110SH	Sleeve	100~125	50/60	0.25	21	2300/2700	39/42	96/112	57/66	1	/
12025-230SH	Sleeve	200~240	50/60	0.13	21	2300/2700	39/42	96/112	57/66	1	/
12025-110SM	Sleeve	100~125	50/60	0.16	16	1800/2300	31/36	76/95	45/56	1	/
12025-230SM	Sleeve	200~240	50/60	0.08	16	1800/2300	31/36	76/95	45/56	1	/

"B" means Ball, "S" means Sleeve, "H" means High Speed, "M" means Middle Speed, Current, Speed can be customer made

