

THIS DOCUMENT IS THE PROPERTY OF KEYSTONE ELECTRONICS CORP. AND SHALL NOT BE REPRODUCED, DISTRIBUTED OR USED AS A BASIS FOR MANUFACTURE WITHOUT PRIOR WRITTEN PERMISSION FROM KEYSTONE ELECTRONICS CORP.

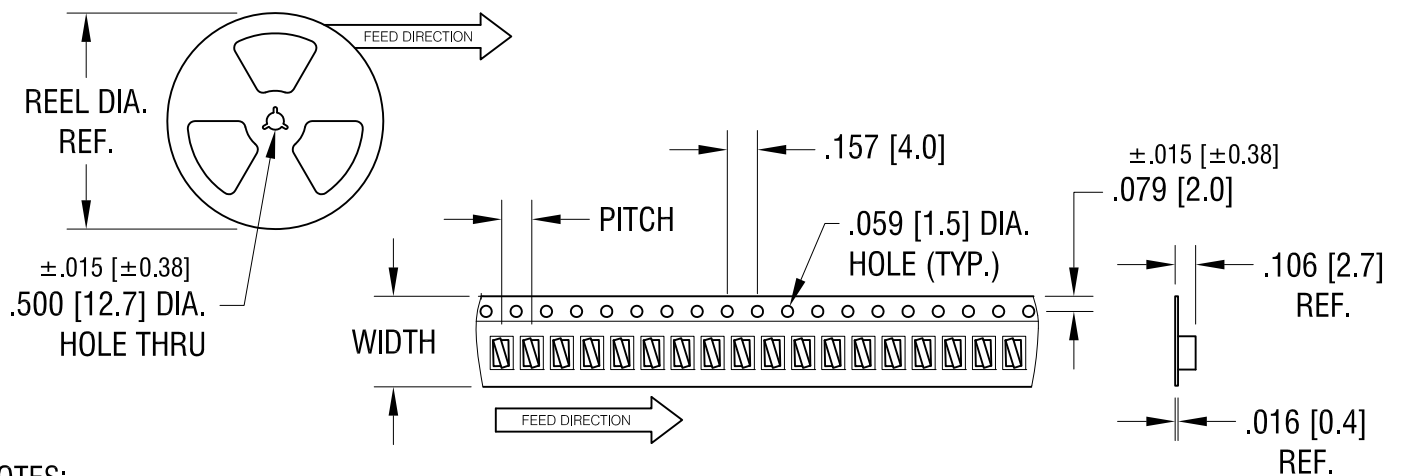
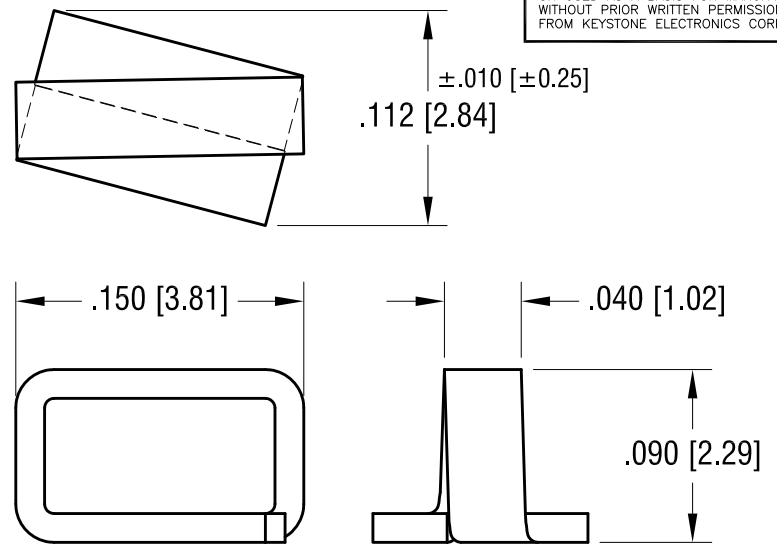
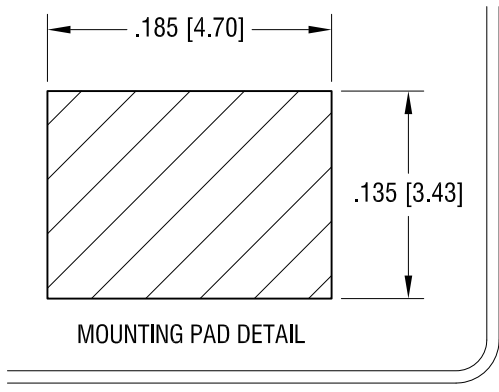

NOTES:

1. SUPPLIED ON TAPE AND REEL ONLY.
TAPE AND REEL SPECIFICATIONS:
2. TAPE:
MAT'L - ALL CONDUCTIVE POLYSTYRENE CARRIER
ANSI/EIA-481 STANDARD
.472 [12.0] WIDE; .157 [4.0] PITCH
3. REEL:
7.0 [177.8] DIA. 1000 PIECES OF
PART NO. 5016 PER REEL.

3.18.14	CHANGE AS PER ECN 14-031	D
6.21.12	CHANGE AS PER ECN 12-078	C
2.5.08	CHANGE AS PER ECN 08-071	B
5.19.04	CHANGE AS PER ECN 04-037	A
DATE	DESCRIPTION	REV.

KEYSTONE ELECTRONICS CORP.			
www.keyelco.com • ASTORIA, N.Y. 11105-2017 • Tel (718) 956-8900			
PART NAME			
TEST POINT, COMPACT, SURFACE MOUNT			
MATERIAL			
.015 [0.38] TH'K PHOSPHOR BRONZE			
FINISH		DRN BY	DATE
SILVER PLATE		BOONE	5.1.01
		APP'D	SCALE
		LN	10X, 1X
TOLERANCES	INCH [MM]	CODE	DWG NO.
DECIMAL	± .005 [± 0.15]	C	5016
ANGULAR	± 1°		
UNLESS OTHERWISE SPECIFIED			