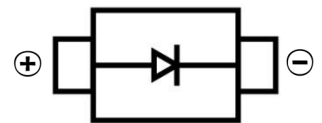

SCHOTTKY BARRIER DIODE
FEATURES

- Small Surface Mount device
- Low power loss, high efficiency
- High temperature soldering guaranteed: 260°C/10 seconds at terminals
- Guard ring for over voltage protection
- For use in low voltage high frequency inverters, free wheeling, and polarity protection applications

SOD-123FL
MECHANICAL DATA

- Case: SOD-123FL
- Case Material: Molded Plastic. UL flammability
- Classification Rating: 94V-0
- Moisture Sensitivity: Level 1 per J-STD-020
- Weight: 0.0155 grams (approximate)

MAXIMUM RATINGS (T_A = 25°C unless otherwise noted)

Parameter	Symbol	Value	Unit
Repetitive peak reverse voltage	V _{RRM}	60	V
DC Reverse Voltage	V _R	60	V
RMS Reverse Voltage	V _{RMS}	42	V
Non-Repetitive Peak Forward Surge Current @ t = 8.3 ms	I _{FSM}	30	A
Mean rectifying current	I _F	1	A
Thermal Resistance From Junction To Ambient	R _{θJA}	110	°C/W
Junction Temperature	T _J	150	°C
Storage Temperature	T _{STG}	-55 ~ +175	°C

ELECTRICAL CHARACTERISTICS (T_A = 25°C unless otherwise specified)

Parameter	Symbol	Min	Max	Unit	Conditions
Forward voltage	V _F		0.70	V	I _F =1A
Reverse current T=25°C	I _R		0.50	mA	V _R =60V
Reverse current T=100°C	I _R		10	mA	V _R =60V
Junction capacitance	C _J		160	pF	V=4V, f=1MH

SCHOTTKY BARRIER DIODE

Typical Characteristics

FIG.1 FORWARD CURRENT DERATING CURVE

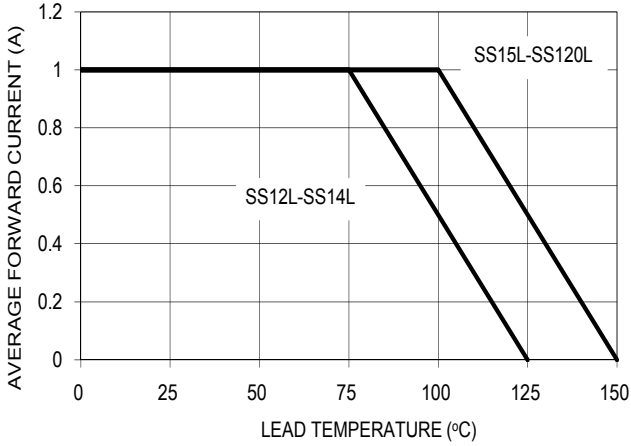

FIG. 2 MAXIMUM FORWARD SURGE CURRENT

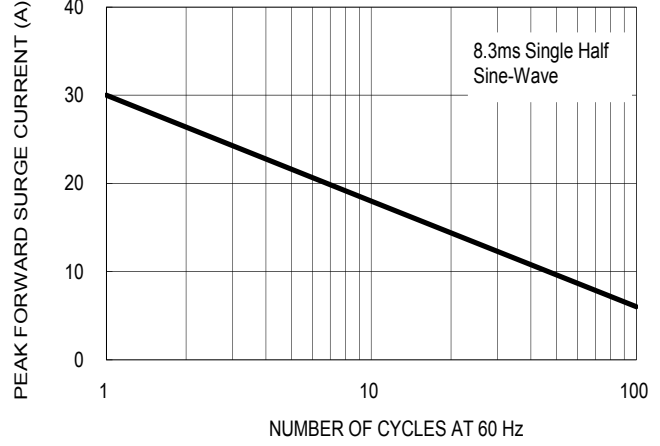

FIG. 3 TYPICAL FORWARD CHARACTERISTICS

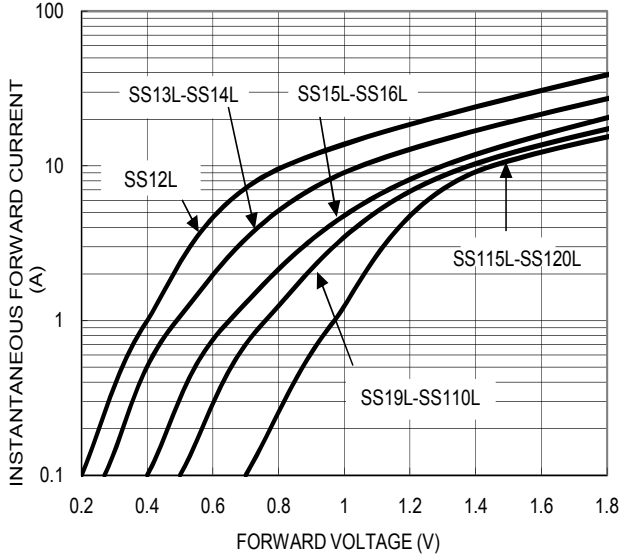

FIG. 4 TYPICAL REVERSE CHARACTERISTICS

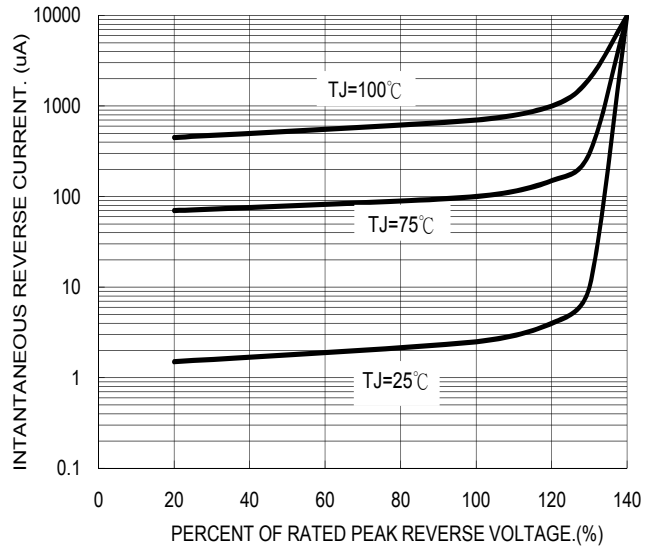

FIG. 5 TYPICAL JUNCTION CAPACITANCE

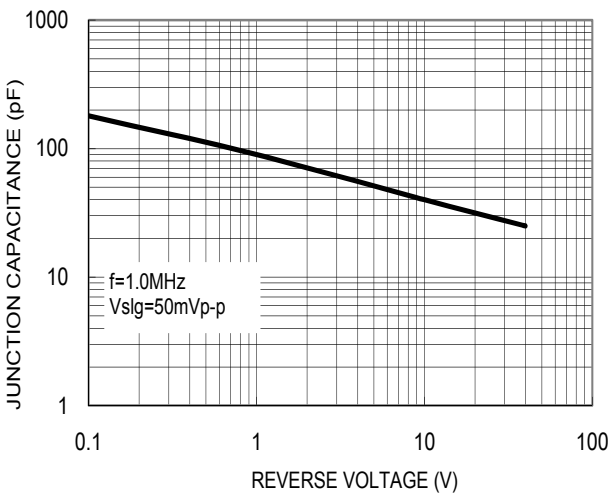
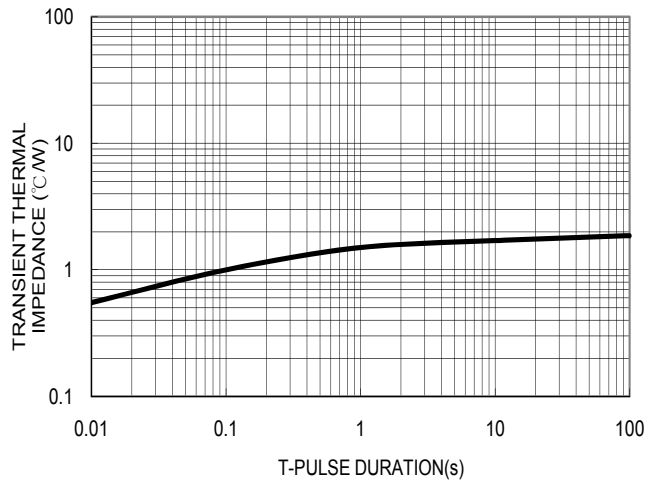
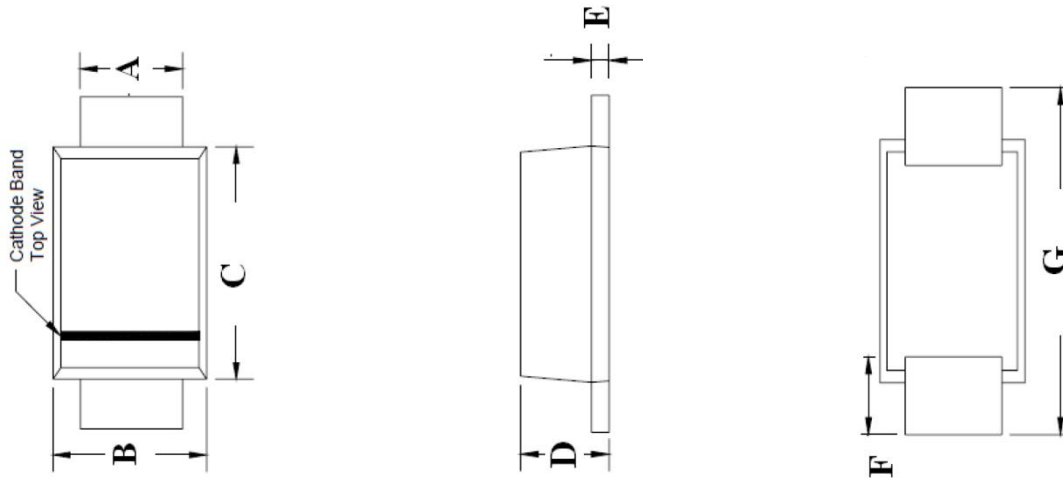

FIG. 6 TYPICAL TRANSIENT THERMAL IMPEDANCE



SCHOTTKY BARRIER DIODE

SOD-123FL Package Outline Dimensions



Symbol	Dimensions In Millimeters		Dimensions In Inches	
	Min.	Max.	Min.	Max.
A	0.75	0.95	0.029	0.037
B	1.60	2.00	0.063	0.079
C	2.60	3.00	0.103	0.119
D	0.90	1.20	0.036	0.047
E	0.12	0.22	0.005	0.009
F	0.8Typ		0.032Typ	
G	3.50	3.90	0.138	0.159

SOD-123FL Suggested Pad Layout

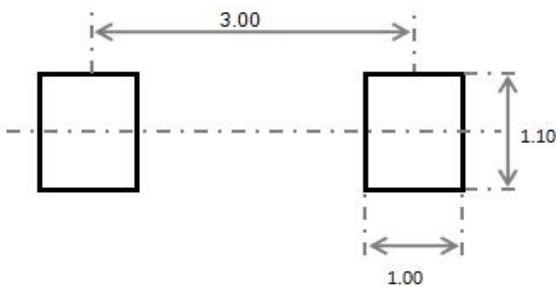

Note:

1. Controlling dimension: in millimeters
2. General tolerance: $\pm 0.05\text{mm}$
3. The pad layout is for reference purposes only

SCHOTTKY BARRIER DIODE

SOD-123FL Tape and Reel

SOD-123FL Embossed Carrier Tape

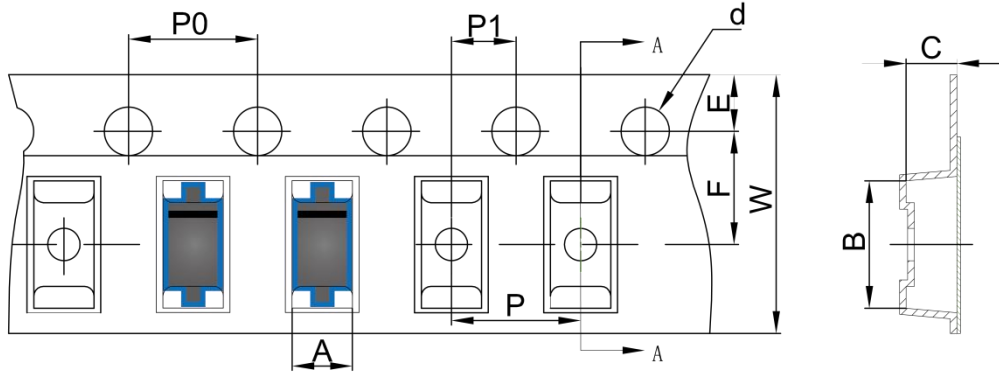

DIMENSIONS ARE IN MILLIMETER										
TYPE	A	B	C	d	E	F	P0	P	P1	W
SOD-123FL	2.10	4.00	1.25	Ø1.50	1.75	3.50	4.00	4.00	2.00	8.00
TOLERANCE	±0.1	±0.1	±0.1	±0.1	±0.1	±0.1	±0.1	±0.1	±0.1	±0.1

SOD-123FL Tape Leader and Trailer

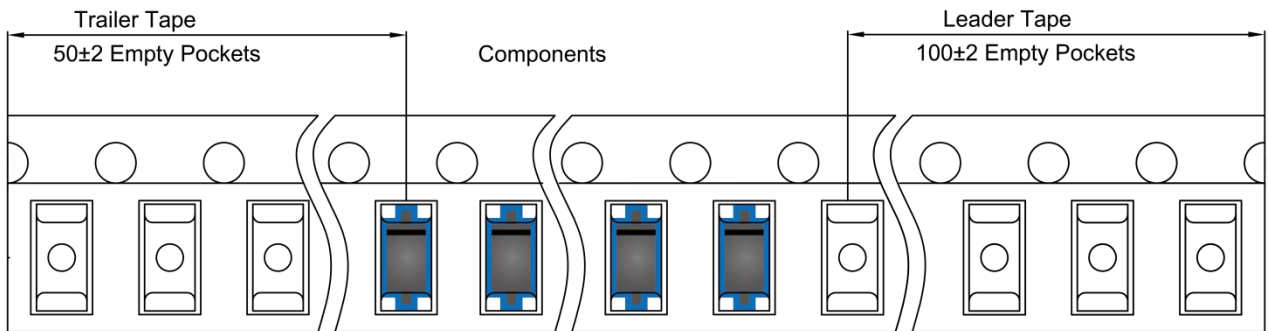

SOD-123FL Reel

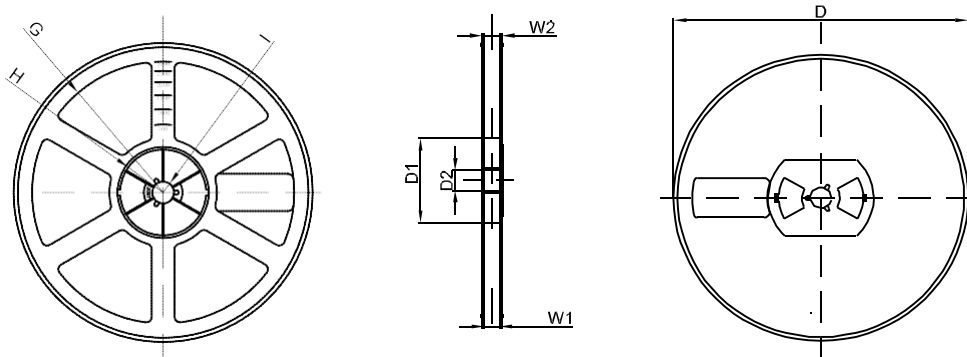

DIMENSIONS ARE IN MILLIMETER								
REEL OPTION	D	D1	D2	G	H	I	W1	W2
7" DIA	Ø178	54.40	13.00	R78	R25.60	R6.50	9.50	12.30
TOLERANCE	±2	±1	±1	±1	±1	±1	±1	±1