

OVERVIEW

NevadaNano's MPS Flammable Gas Sensor 5.0 represents the fifth-generation of this breakthrough technology, delivering industry-leading performance with a low cost of ownership. The smart sensor quickly detects, quantifies, and classifies myriad flammable gases and gas mixtures with unprecedented TrueLEL™ accuracy. It comes already factory calibrated for its entire 15+ year life—no field calibrations are required—and has built-in environmental compensation and automatic self-testing for fail-safe operation. The sensor is robust, inherently immune to poisoning, and certified intrinsically safe. Sensor readings are output on a digital bus or a configurable analog output.

TrueLEL™ GAS DETECTION

Gas	Formula	Detection Range	Accuracy (0-50 %LEL)
butane	C ₄ H ₁₀	0-100 %LEL	±5 %LEL
ethane	C ₂ H ₆	0-100 %LEL	±5 %LEL
hydrogen	H ₂	0-100 %LEL	±5 %LEL
isobutane	HC(CH ₃) ₃	0-100 %LEL	±5 %LEL
isobutylene	C ₄ H ₈	0-100 %LEL	±5 %LEL
isopropanol	C ₃ H ₈ O	0-100 %LEL	±10 %LEL
methane	CH₄	0-100 %LEL	±3 %LEL
methyl ethyl ketone	C ₄ H ₈ O	0-100 %LEL	±5 %LEL
octane	C ₈ H ₁₈	0-100 %LEL	±12 %LEL
pentane	C ₅ H ₁₂	0-100 %LEL	±7 %LEL
propane	C ₃ H ₈	0-100 %LEL	±7 %LEL
propylene	C ₃ H ₆	0-100 %LEL	±5 %LEL
toluene	C ₇ H ₈	0-100 %LEL	±12 %LEL
xylene	C ₈ H ₁₀	0-100 %LEL	±12 %LEL

Accuracy guaranteed for methane and hydrogen across full environmental range. Other gases will typically meet the published tolerances across the full environmental range, but are guaranteed only near standard conditions of 20 °C, 50 %RH. The sensor is capable of detecting most common flammable gases/vapors (see page 5).

PERFORMANCE

Resolution	0.1 %LEL
Response time (T90)	< 20 seconds
Calibration	Factory calibrated

ENVIRONMENTAL OPERATING RANGE

Temperature	-40 to 75 °C
Humidity	0 to 100 %RH
Pressure	80 to 120 kPa



Series 4 ("S4")



Mini



KEY FEATURES

- Automatic multi-gas accuracy in real-time
- Built-in environmental compensation
- EN50271 compliant (in certification)
- Compliant to IEC 60079-29-1:2020
- No calibration required
- Supports 15+ year lifetimes
- Can be powered by 3V
- Low ave. power: 27.3 mW typical at 3V
- Extremely poison resistant
- Intrinsically safe (IS) certified
- Built-in self-test for fail-safe operation
- Custom analog out configurations
- Can detect gas presence at start-up

OPERATING PRINCIPLE

The MPS transducer is a patented micro-machined membrane with an embedded Joule heater and resistance thermometer. The transducer is mounted on a PCB and packaged inside a rugged enclosure open to ambient air. Presence of a flammable gas causes changes in the thermodynamic properties of the air/gas mixture that are measured by the transducer. Sensor data are processed by patented algorithms to report an accurate concentration and classify the flammable gas.

GAS CLASSIFICATION

The old way: Conventional sensing technologies (e.g. catalytic bead, NDIR) use a “k-factor” multiplier to convert raw sensor signals to gas concentrations in %LEL. These “k-factors” are based on known relative sensitivities of these sensors to different gases. A single “k-factor,” corresponding to a particular gas, must be selected manually during system setup. When the sensor is later exposed to any gas other than the one selected, significant errors in reported concentration can occur.

The MPS way: The MPS sensor applies conversion factors automatically and in real-time, based on the “live” measured thermal properties of the ambient air/gas and the current environmental conditions. The %LEL values reported for the bulk, which may contain a mixture of gases, achieve the same high levels of accuracy as those achieved with single gases.

The sensor also automatically outputs the class of flammable gas present, in the following categories:

CLASS 1: Hydrogen

Molecular Weight: 2.0 [g/mol]
Density: 0.09 [kg/m³]
Number of Carbons: 0



CLASS 2: Hydrogen Mixture

Avg. Mol. Weight: 1-14 [g/mol]
Avg. Density: 0.1-0.6 [kg/m³]
Number of Carbons: varies

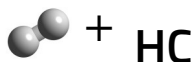

This classification is unique as it guarantees the presence of hydrogen and another flammable gas

CLASS 3: Methane/Natural Gas

Avg. Mol. Weight: 16 to 19 [g/mol]
Avg. Density: 0.6-0.9 [kg/m³]
Typical Number of Carbons: 0-2



Gases having molecular properties similar to that of methane may be classified as methane (e.g. ammonia, acetylene)

CLASS 4: Light Gas (or Light Gas Mixture)

Avg. Mol. Weight: 25 to 75 [g/mol]
Avg. Density: 1.2-2.5 [kg/m³]
Typical Number of Carbons: 1-4

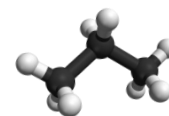

Example Gases: Ethane, Propane, Isopropanol

CLASS 5: Medium Gas (or Medium Gas Mixture)

Avg. Mol. Weight: 50 to 120 [g/mol]
Avg. Density: 1.5-4.0 [kg/m³]
Typical Number of Carbons: 2-8

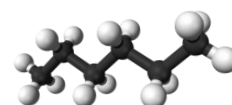

Example Gas: Pentane

CLASS 6: Heavy Gas (or Heavy Gas Mixture)

Avg. Mol. Weight: 80+ [g/mol]
Avg. Density: 3.5+ [kg/m³]
Typical Number of Carbons: 6+

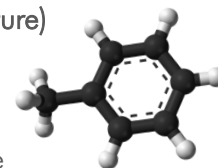

Example Gases: Octane, Toluene, Xylene

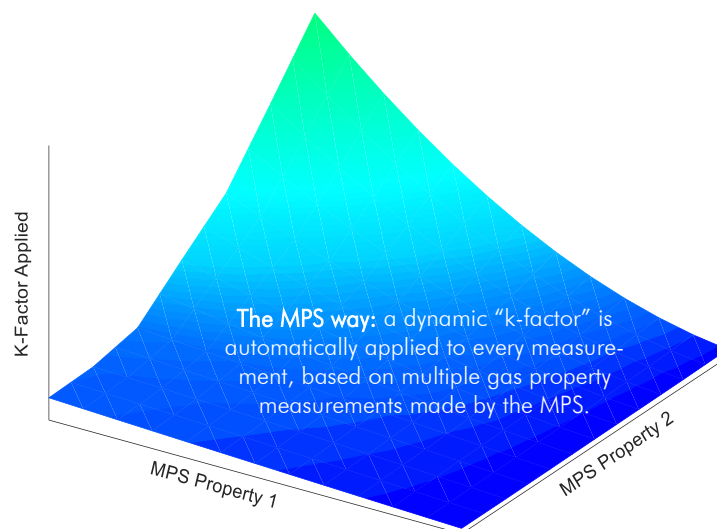

SELF-DIAGNOSTICS

The MPS Flammable Gas Sensor 5.0 automatically performs a comprehensive sequence of self-checks at power-up, and every 2 seconds during operation to ensure fail-safe operation. The MPS alerts the user of any sensor failure or status alert. For additional information on how to interpret and handle detected faults, refer to the MPS Flammable Gas Sensor 5.0 User Manual at www.nevedanano.com/downloads

SM-DS-0012-02

MECHANICAL AND ELECTRICAL INTEGRATION—S4

The intrinsically safe version of the MPS Flammable Gas Sensor 5.0 has a standard “4 series” form factor. The sensor interface pins are compatible with industry-standard receptacles or socket assemblies.

MECHANICAL

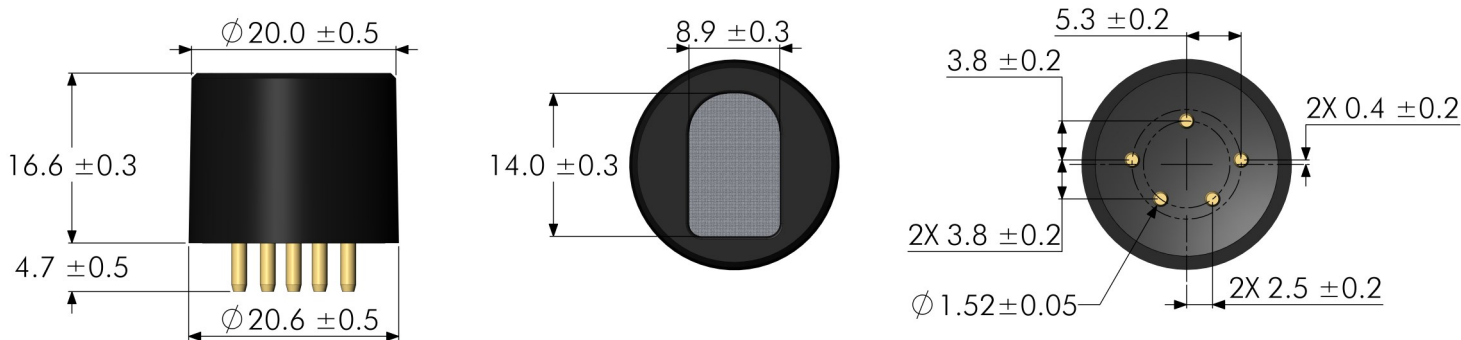

Dimensions in mm

Dimensions	16.6 mm (H) x 20.0 mm (D)
Mass	8.0 ± 0.5 grams
Body material	Ultem PEI

ELECTRICAL

Operating voltage	3.0 - 5.0 ± 5% VDC		
Current consumption (typical)	Range	Start-up (~30 sec)	Average
	6-22 mA	21.1 mA, 3.3V supply 22.0 mA, 5.0V supply	9.1 mA, 3.3V supply 9.3 mA, 5.0V supply

5-pin
Digital Input/Output

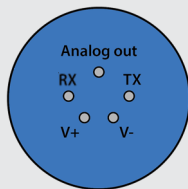

Bottom View

Communication: UART
 Logic signaling standard: 3.0 V
 Baud rate: 38,400. 8 data, 1 stop bits. No parity.
 RX Data Input : Do not exceed 3.6 V
 Input High Voltage (V_{IH}) = 2.0 V minimum
 Input Low Voltage (V_{IL}) = 0.85 V maximum
 TX Data Output : Source / Sink 4 mA maximum
 Output High Voltage (V_{OH}) = 2.45 V minimum
 Output Low Voltage (V_{OL}) = 0.45 V maximum
 Programmable Analog out (optional)

3-pin Pellistor Replacement
Programmable Output

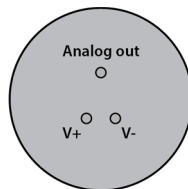

Bottom View

Industry standard 0.4 to 2.0 Volt linearized, compensated for temperature, humidity and pressure. Alternate configurations available, with fault voltage, startup behavior and timing, and “zero” all available between 0.04 and 2.4 Volts, with customized sensitivity slopes (including rising or falling Volts per %LEL).
 Contact NevadaNano for details.

MECHANICAL AND ELECTRICAL INTEGRATION—MINI

The “Mini” form factor version of the MPS Flammable Gas Sensor 5.0 is designed to be permanently mounted to a printed circuit board. In addition to the electrical interconnects, the Mini package has two features that can engage with two, unplated 1.10—1.50 mm diameter holes on the PCB for a precise and secure position of the sensor relative to the PCB.

MECHANICAL

Mass	4.3 ± 0.5 grams
Body material	PEI

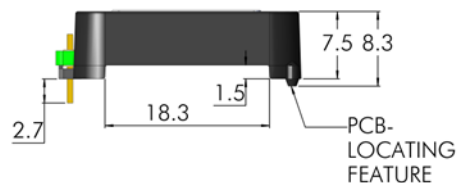
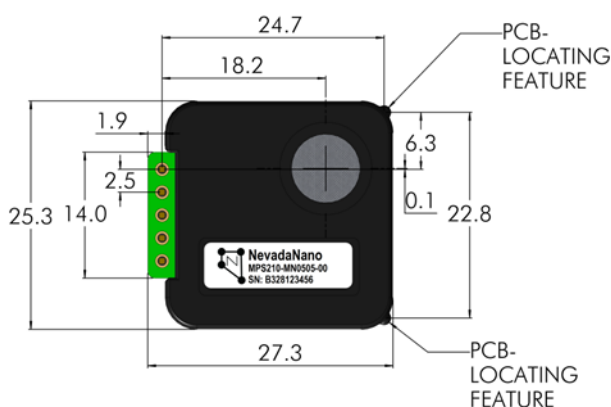

Dimensions in mm

ELECTRICAL

Operating voltage	3.0 - 5.0 ±5% VDC
-------------------	-------------------

Current consumption (typical)	Range	Start-up (~30 sec)	Average
	6-22 mA	21.1 mA, 3.3V supply 22.0 mA, 5.0V supply	9.1 mA, 3.3V supply 9.3 mA, 5.0V supply

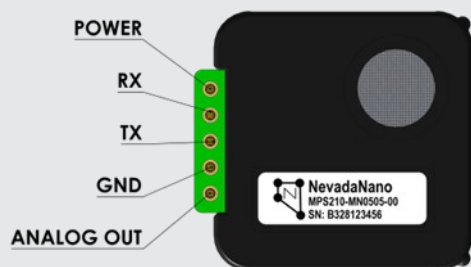

Communication: UART
 Logic signaling standard: 3.0 V
 Baud rate: 38,400. 8 data, 1 stop bits. No parity.
 RX Data Input : Do not exceed 3.6 V
 Input High Voltage (V_{IH}) = 2.0 V minimum
 Input Low Voltage (V_{IL}) = 0.85 V maximum
 TX Data Output : Source / Sink 4 mA maximum
 Output High Voltage (V_{OH}) = 2.45 V minimum
 Output Low Voltage (V_{OL}) = 0.45 V maximum
 Programmable Analog out (optional)

Analog voltage output (“Analog Out”)

Industry standard 0.4 to 2.0 Volt linearized, compensated for temperature, humidity and pressure. Alternate configurations available, with fault voltage, startup behavior and timing, and “zero” all available between 0.04 and 2.4 Volts, with customized sensitivity slopes (including rising or falling Volts per %LEL). Contact NevadaNano for details.

FLAMMABLE GASES DETECTED

The volume percentage (%VOL) corresponding to 100 %LEL for a given gas varies across regions and standards due to differences in criteria, including the methods used for ignition and for the determination of an explosion. The MPS Flammable Gas Sensor 5.0 is factory calibrated to achieve the accuracy levels shown below without any further recalibration or adjustment. The 5-pin digital version of the sensor can be queried via UART to report %LEL concentrations in accordance to either the ISO 10156 standard or the IEC60079-20-1 and companion specification EN61779. The 3-pin, analog-out version comes in two configurations, one with an output in accordance with ISO and one in accordance with IEC. (Note, the IEC output is the ISO output multiplied by 1.136).

The MPS as configured is confirmed to detect a variety of other gases not shown in the table below. These include: 1-butene, acetylene, ammonia, cyclohexane, decane, diesel, dimethyl carbonate, ethanol, gasoline vapors, hexane, and methanol. The sensor does not provide TrueLEL accuracy to these gases and will systematically over- or under-report, depending on the gas, and special precautions should be taken when using the MPS to detect these gases. Contact info@nevedanano.com for more information.

Gas	Formula	Class ⁴	Detection Range [%LEL]	% Volume of gas at 100 %LEL (ISO 10156)	MPS Accuracy 0 to 50 %LEL (ISO 10156)	% Volume of gas at 100 %LEL (IEC60079-20-1)	MPS Accuracy 0 to 50 %LEL (IEC60079-20-1)
butane	C ₄ H ₁₀	4	0-100	1.8 %VOL	±5 %LEL	1.4 %VOL	±9 %LEL
ethane	C ₂ H ₆	4	0-100	3.0 %VOL	±5 %LEL	2.4 %VOL	±5 %LEL
hydrogen	H ₂	1	0-100	4.0 %VOL	±5 %LEL	4.0 %VOL	±7 %LEL
isobutane	HC(CH ₃) ₃	4	0-100	1.8 %VOL	±5 %LEL	1.3 %VOL	±9 %LEL
isobutylene	C ₄ H ₈	4	0-100	1.8 %VOL	±5 %LEL	1.8 %VOL	±5 %LEL
isopropanol	C ₃ H ₈ O	4	0-100	2.0 %VOL	±10 %LEL	2.0 %VOL	+20 %LEL
methane	CH ₄	3	0-100	5.0 %VOL	±3 %LEL	4.4 %VOL	±3 %LEL
MEK	C ₄ H ₈ O	5	0-100	1.4 %VOL	±5 %LEL	1.5 %VOL	+16 %LEL
pentane	C ₅ H ₁₂	5	0-100	1.5 %VOL	±7 %LEL	1.1 %VOL	±10 %LEL
propane	C ₃ H ₈	4	0-100	2.1 %VOL	±7 %LEL	1.7 %VOL	±10 %LEL
propylene	C ₃ H ₆	4	0-100	2.4 %VOL	±5 %LEL	2.0 %VOL	±5 %LEL
acetone	C ₃ H ₆ O	5	0-100	2.5 %VOL	+20 %LEL	2.5 %VOL	+24 %LEL
ethylene	C ₂ H ₄	4	0-100	2.7 %VOL	-12 %LEL	2.3 %VOL	-14 %LEL
heptane	C ₇ H ₁₆	5	0-100	1.1 %VOL	±12 %LEL	0.85 %VOL	±15 %LEL
octane	C ₈ H ₁₈	6	0-100	1.0 %VOL	±12 %LEL	0.8 %VOL	±15 %LEL
styrene	C ₈ H ₈	6	0-100	1.1 %VOL	-20 %LEL	1.0 %VOL	-17 %LEL
toluene	C ₇ H ₈	6	0-100	1.2 %VOL	±12 %LEL	1.0 %VOL	±13 %LEL
xylene	C ₈ H ₁₀	6	0-100	1.1 %VOL	±12 %LEL	1.0 %VOL	±13 %LEL

- Notes:
- 1) Accuracy guaranteed for methane and hydrogen across full environmental range.
 - 2) Other gases will typically meet published tolerances across the full environmental range, but guaranteed only near standard conditions of 20°C, 50%RH.
 - 3) Accuracy (+) %LEL corresponds to a higher-than-delivered reading and Accuracy (-) %LEL corresponds to a lower-than-delivered reading.
 - 4) Refer to Gas Classification section on page 2 for value descriptions. Class values shown in table will typically be accurate across the full environmental range, but were determined near standard conditions of 20°C, 50%RH.

TYPICAL GAS PERFORMANCE CHARACTERISTICS

Accuracy to Representative Gases

Data points are averages of 10 sensors. Error bars indicate minimum and maximum readings. Note: all performance data provided was collected using standard, factory-calibrated MPS sensors. No recalibration for specific gases is necessary to achieve these results.

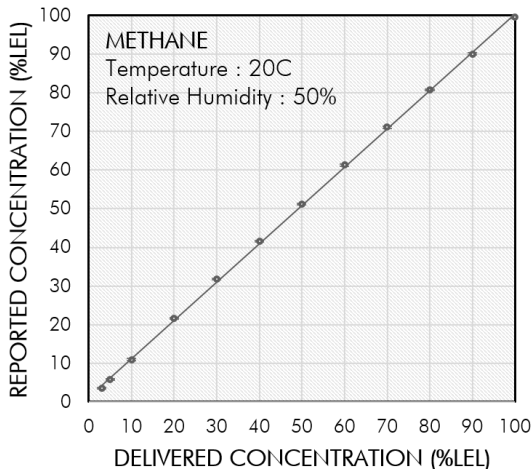
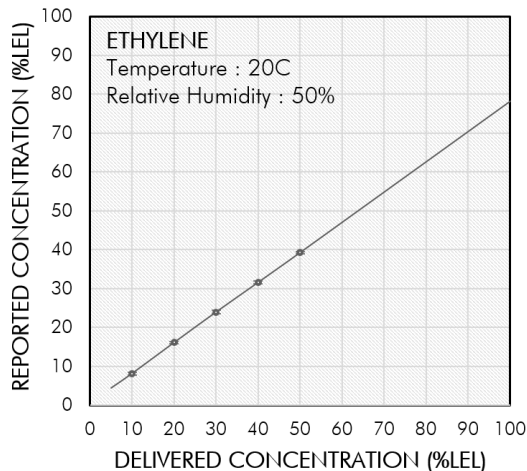
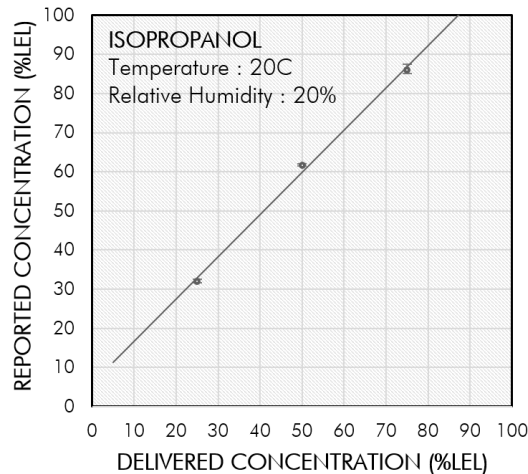
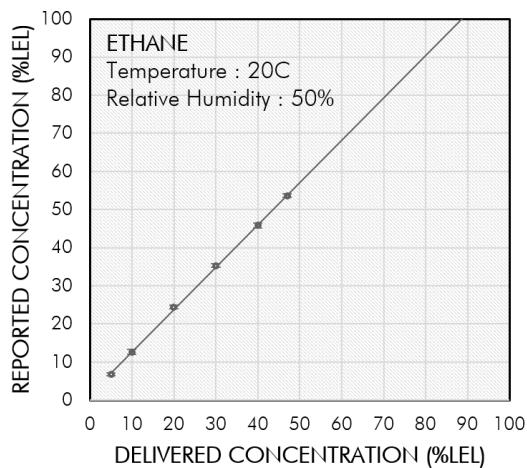
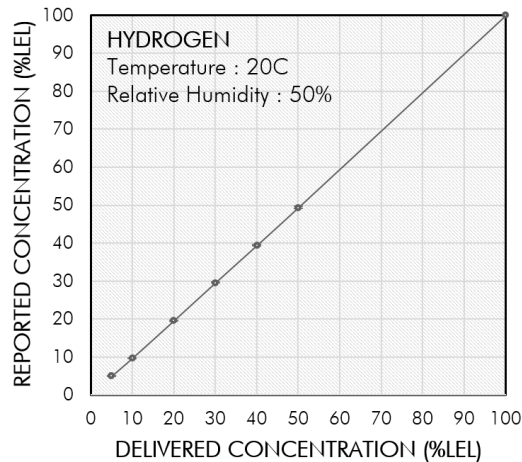
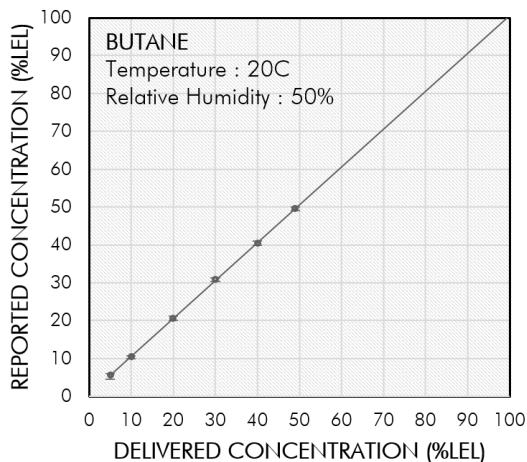

TYPICAL GAS PERFORMANCE CHARACTERISTICS

Accuracy to Representative Gases - Continued

Data points are averages of 10 sensors. Error bars indicate minimum and maximum readings. Note: all performance data provided was collected using standard, factory-calibrated MPS sensors. No recalibration for specific gases is necessary to achieve these results.

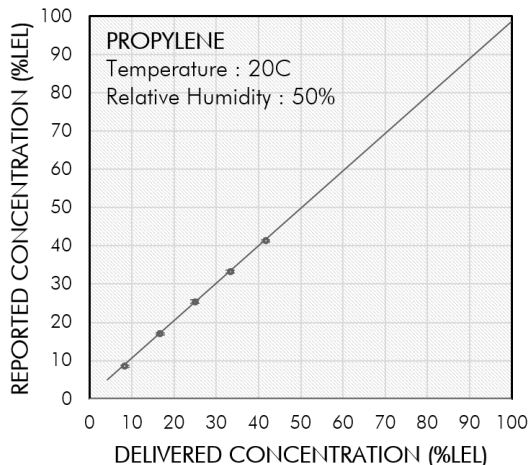
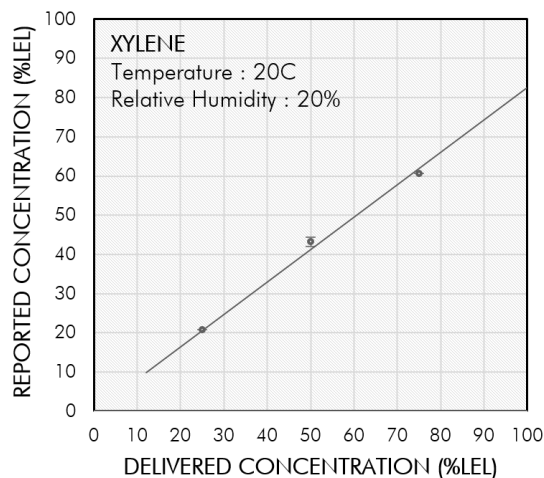
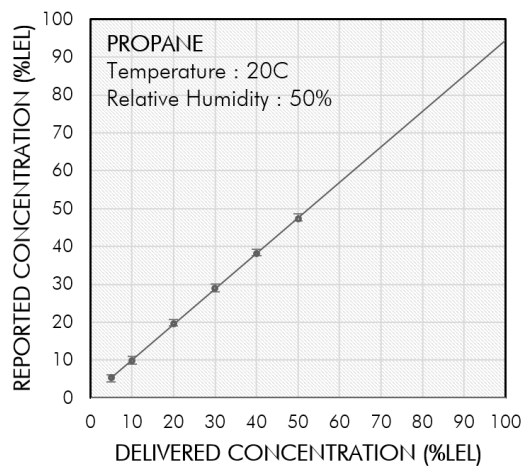
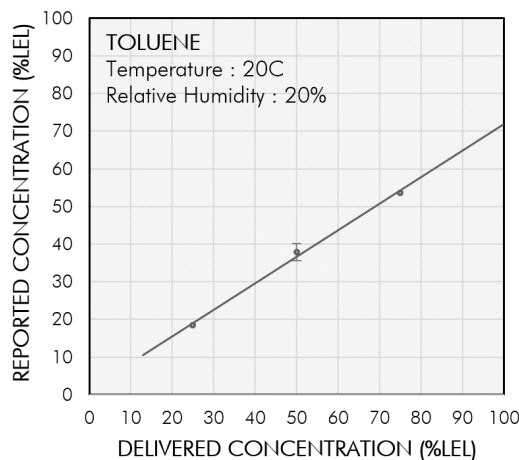
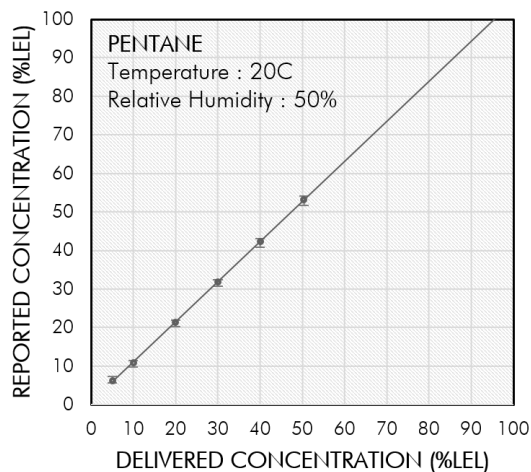

TYPICAL GAS PERFORMANCE CHARACTERISTICS

Long-Term Accuracy/Stability

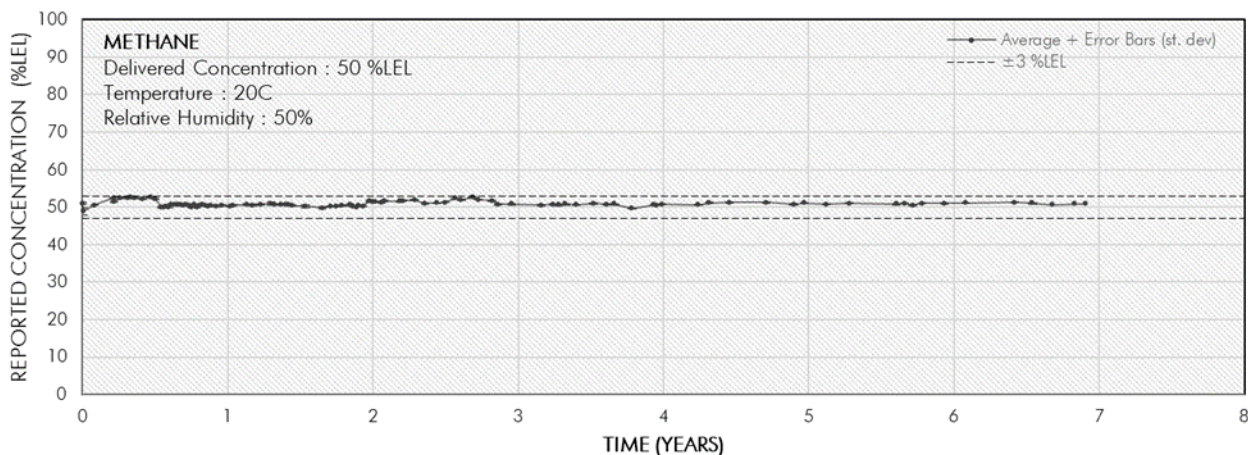

Average concentration reported to repeated exposures of 50 %LEL methane vs. time. Between exposures, all sensors operated continuously in clean air. During exposures, all sensors were placed in an environmental chamber set at standard conditions (20 °C, 50 %RH) where gas was delivered from a cylinder. Accuracy has remained within ±3 %LEL to date. The test is ongoing.

Repeatability

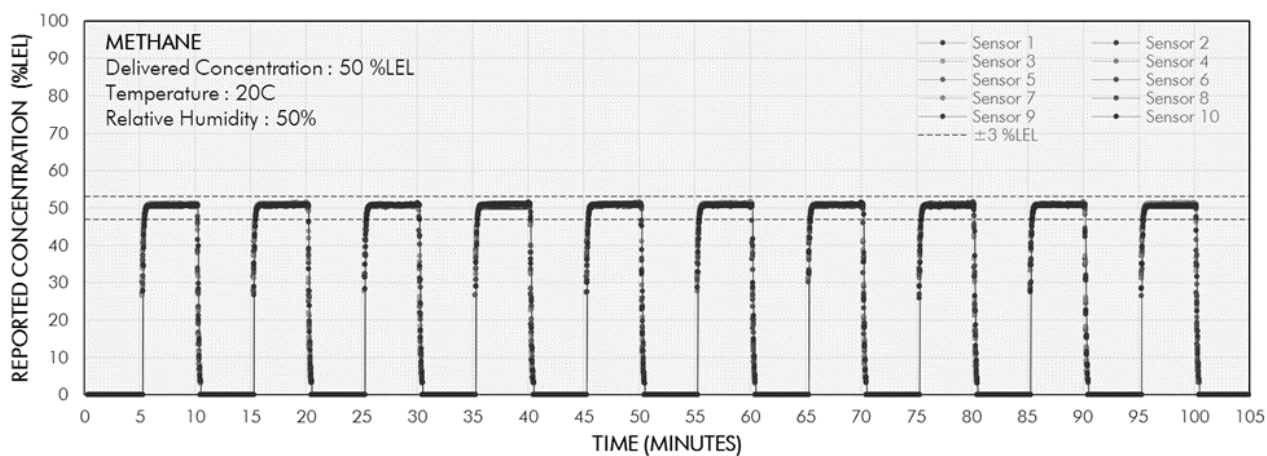

Sensor #	Average [%LEL]	Standard Deviation [%LEL]
Sensor 1	50.8	0.15
Sensor 2	50.5	0.18
Sensor 3	50.9	0.13
Sensor 4	50.7	0.22
Sensor 5	50.7	0.14
Sensor 6	50.7	0.13
Sensor 7	50.7	0.14
Sensor 8	50.6	0.18
Sensor 9	50.7	0.10
Sensor 10	50.6	0.17

Top: methane concentration reported to 10 exposures over 100 minutes by 10 MPS sensors. Bottom: table shows the averages and standard deviations of the concentrations reported during this test, by sensor. Standard deviation over 10 exposures is less than 0.25 %LEL.

SM-DS-0012-02

FLAMMABLE GASES NOT DETECTED

The MPS Flammable Gas Sensor 5.0, as currently configured, does not detect:

- **Carbon Monoxide (CO):** CO is a toxic gas, immediately dangerous to life and health (IDLH) at 1,200 ppm; the lower explosive limit is 109,000 ppm. The sensor is immune to poisoning by CO.
- **Hydrogen Sulfide (H₂S):** H₂S is a toxic gas, immediately dangerous to life and health (IDLH) at 100 ppm; the lower explosive limit is 40,000 ppm. The sensor is immune to poisoning by H₂S.

There may be other gases the sensor does not detect that have not yet been assessed or tested. For additional information about a particular flammable gas, please contact NevadaNano at www.nevadanano.com.

RESPONSE TO NON-FLAMMABLE GASES

Because the MPS performs an analysis of the molecular properties of a given “air” sample, large-scale fluctuations in the relative concentrations of the components in the air can affect accuracy. False readings can occur at non-flammable gas concentration variations (from normal air) greater than about 1 %VOL (~10,000 ppm), as discussed below; accuracy of the %LEL readings can be impacted at concentration variations (from normal air) greater than about 0.1 %VOL (~1,000 ppm).





- **Oxygen (O₂):** Normal air has an O₂ concentration of 20.95% by volume. Higher ambient O₂ concentrations up to ~21.8 %VOL have little to no effect on the sensor. Concentrations exceeding this can be reported as a flammable gas at %LEL levels. The cross sensitivity is approximately 1.07 %LEL per 1 %vol O₂ (e.g., oxygen at 30 %vol in air, a 9.1 %vol enrichment, would read approximately 9.7 %LEL and be identified as Class 2 - Hydrogen Mixture). The sensor is immune to poisoning by O₂.
 - Note: if O₂ concentrations *decrease*, the sensor response will depend on what gas is displacing the oxygen. Flammable gases displace oxygen. Methane at 100 %LEL (5 %VOL methane) will reduce oxygen's relative concentration by 1.05 %VOL in ambient air, meaning the O₂ concentration decreases from 20.9 to 19.85 %VOL. Such flammable-gas-caused O₂ depletions are already taken into account by the sensor calibration and therefore cause no unwanted effects on sensor output.
 - NevadaNano has conducted testing to demonstrate the effect of extreme oxygen depletion. A gas stream containing 2.5 %VOL methane in balance zero air was diluted using a stream containing pure nitrogen to achieve 15, 10, and 5 %VOL O₂ levels. Note that the concentration of methane decreases as pure nitrogen is introduced into the gas stream. Calculated concentrations and the %LEL reported by the MPS are shown below.

	Nitrogen [%VOL]	Oxygen [%VOL]	Methane [%VOL]	Calculated [%LEL]	MPS error [%LEL]
50 %LEL Methane in Zero Air	77.1	20.4	2.5	50.0	+1.0
Diluting with N ₂ to 15 %O ₂	83.2	15.0	1.8	36.0	-6.0
Diluting with N ₂ to 10 %O ₂	88.8	10.0	1.2	24.0	-7.0
Diluting with N ₂ to 5 %O ₂	94.4	5.0	0.6	12.0	-12.0

*Calculated %LEL assumes normal “air” as the background. Actual %LEL is dictated by limiting oxygen concentration.

- **Carbon Dioxide (CO₂):** CO₂ is present at concentrations near 400 ppm in normal air. This ambient level of CO₂ is already taken into account by sensor calibrations. The sensor is unaffected by elevated CO₂ concentrations up to approximately 5,000 ppm. Concentrations above this can be misinterpreted by the sensor as flammable gas. The cross sensitivity is approximately 1.74 %LEL per 1,000 ppm CO₂ (e.g., CO₂ at 10,000 ppm would read approximately 17.4 %LEL). The sensor is immune to poisoning by CO₂.
 - Note: Exhaled human breath contains CO₂ at concentrations of approximately 4-5 %VOL (40,000-50,000 ppm). (During respiration, the CO₂ replaces oxygen, reducing its concentration from 20.95% by volume in normal air to 13.6-16% in exhaled air.) **As such, breathing directly onto the sensor can cause it to falsely report flammable gas for a brief period.**

CERTIFICATION—S4 (INTRINSICALLY SAFE) FORM FACTOR ONLY

Certification Body		 ATEX NB 2809 UKEX AB 1725		
Test Standard	IEC 60079-0:2017 IEC 60079-11:2011	EN 60079-0:2018 EN 60079-11:2012	FM 3600:2018 FM 3610:2018 ANSI/UL 913:2019	CSA 22.2 60079-0:2019 CSA 22.2 60079-11:2014
Protection Categories	Ex ia IIC Ga Ex ia IIIC Da Ta = -40°C to 75°C	 II 1 G Ex ia IIC Ga  II 1 D Ex ia IIIC Da Ta = -40°C to 75°C	Class I, Division 1, Group A,B,C,D Class II and III, Division 1, Group E,F,G Class I, Zone 0 AEx ia IIC Ga Zone 20 AEx ia IIIC Da Ta = -40°C to 75°C	Class I, Division 1, Group A,B,C,D Class II and III, Division 1, Group E,F,G Class I, Zone 0 Ex ia IIC Ga Zone 20 Ex ia IIIC Da Ta = -40°C to 75°C
Certificate	IECEX FMG 19.0028U	FM19ATEX0184U FM21UKEX0159U	FM19US0145U	FM19CA0077U

For additional information on certifications, refer to the MPS Hazardous Locations User Guide here: www.nevedanano.com/downloads

Certificates of Compliance	Specification	Test Lab/Certification Body	Certificate/Report Number
IECEX Quality Assessment Report	IEC 80079-34:2018	FM Approvals LLC	GB/FME/QAR19.0020/00
ATEX Quality Assurance Notification	2014/34/EU	FM Approvals LLC	FM19ATEXQ0200
UK Quality Assurance Notification	UKSI 2016:1107 (as amended)	FM Approvals LLC	FM21UKQAN0168

Certificates of compliance are available at www.nevedanano.com/downloads or by contacting info@nevedanano.com.

CERTIFICATION—S4 AND MINI

Certificates of Compliance	Specification	Test Lab/Certification Body	Certificate/Report Number
Certificate of Registration of Quality Management System	ISO 9001:2015	National Standards Authority of Ireland (NSAI)	19.8213
RoHS (2 & 3) Compliant	2011/65/EU & 2015/863; includes China RoHS—SJ/T 11363 & 11364	Claigan Environmental & Supplier Declarations	CETR-NNT002.3
REACH Compliant	EC 1907/2006 (33 & 67)	Claigan Environmental & Supplier Declarations	CETR-NNT002.3

Certificates of compliance are available at www.nevadanano.com/downloads or by contacting info@nevadanano.com.

ADDITIONAL TEST STANDARDS

Test	Specification	Summary of Test Conditions
Low Temperature Operating*	IEC 60068-2-1:2007	500 Hours @ -50°C
High Temperature Operating	IEC 60068-2-2:2007	1000 Hours @ 85°C
Mean Time to Failure (MTTF)	IEC 60068-2-2:2007	62 Years at 60 % confidence or 19 years at 99 % confidence
Mechanical Vibration*	IEC 60068-2-6:2008	31Hz – 150 Hz (2G acceleration), 1 hour per axis, 3 axes
Mechanical Shock*	IEC 60068-2-27:2008	50G peak/11ms half sine pulse, 3 axes (positive and negative pulses)
Drop—Free Fall*	IEC 60068-2-31:2008	Procedure I: 1 meter drop onto concrete
Damp heat - steady state	IEC 60068-2-78:2012	500 hours @ 40°C/93% RH <i>[in test]</i>
Temperature cycling	JESD22-A104E	Test Condition N, -40°C to 85°C for 200 cycles
Sand/Dust Ingress Protection*	MIL-STD-810G	Method 510.5 Sand: 150-850 μm SiO ₂ particle size, 23 m/s nom. velocity, 1.5 hrs @ 70°C per axis, 3 axes. Dust: Red China Clay, 1.5 m/s nom. velocity, 6 hrs @ 20°C, 6 hrs @ 70°C
Poisoning*	NevadaNano	1,200 ppm-hours H ₂ S (50 ppm for 24 hours) 10,400 ppm-hours siloxanes (Decamethylcyclopentasiloxane) (100 ppm for 4 hours, then 1,000 ppm for 10 hours) 0.25 ppm-hours NO ₂ (3 ppm for 5 minutes) 0.83 ppm-hours HCN (10 ppm for 5 minutes) 0.75 ppm-hours SO ₂ (9 ppm for 5 minutes) 0.17 ppm-hours Cl ₂ (2 ppm for 5 minutes) 4.17 ppm-hours NH ₃ (50 ppm for 5 minutes)
Electrostatic Discharge Immunity	JEDEC JS001-2017	Human Body Model, passed at 2 kV
EMC: Radio Frequency Electromagnetic Field Immunity	EN 61326-1:2020	Test Method EN 61000-4-3:2013 80 MHz to 6 GHz at 10 V/m, horizontal & vertical polarities. Class A.
EMC: Power Frequency Magnetic Field Immunity	EN 61326-1:2020	Test Method EN 61000-4-8:2010 30 A/m, 3 axes, 50 Hz and 60 Hz
EMC: Radio Frequency Disturbance Characteristics	EN 61326-1:2020	Test Method EN 55011:2010 30 MHz to 1 GHz. Class A.

The table above provides a summary of standardized tests and test conditions to which the MPS Flammable Gas Sensor 5.0 has been subjected and passed by demonstrating performance within the MPS Flammable Gas Sensor 5.0 specification both before and after each test.

*The MPS Flammable Gas Sensor 4.0 hardware passed this test, and the MPS Flammable Gas Sensor 5.0 is qualified by similarity.

PART NUMBER ORDERING GUIDE

Please refer to the following table below when ordering the MPS Flammable Gas Sensor 5.0. When ordering a MPS Evaluation Kit, please specify the MPS Flammable Gas Sensor 5.0 part number to be evaluated.



Manufacturer Part Number	Description
MPSF02-S42505-E0	MPS Flammable Gas Sensor 5.0, S4, 5-Pin, UART + Analog Out
MPSF02-S42309-E0	MPS Flammable Gas Sensor 5.0, S4, 3-Pin, (LEL ISO) Analog Out + Auto Start
MPSF02-S423E9-E0	MPS Flammable Gas Sensor 5.0, S4, 3-Pin, (LEL IEC), Analog Out + Auto Start
MPSF02-S423**-E0	MPS Flammables Sensor 5.0, S4, 3-Pin, (LEL ISO or LEL IEC), Custom Analog Out + Auto Start ** indicates configuration number (e.g. C1)



Manufacturer Part Number	Description
MPSF02-MN0505-00	MPS Flammables Sensor 5.0, Mini, UART + Analog Out
MPSF02-MN05**-00	MPS Flammables Sensor 5.0, Mini, UART + Analog Out Custom Analog Out ** indicates configuration number (e.g. C1)



Manufacturer Part Number	Description
MPS999-S40000-99	MPS S4 Evaluation Kit (S4 sensor not included)
MPS999-MN0000-99	MPS Mini Evaluation Kit (not pictured; Mini sensor not included)



Nevada Nanotech Systems Inc.
 1395 Greg Street, Suite 102
 Sparks, Nevada 89431
 United States
 Tel: +1 775 972 8943
 Fax: +1 775 972 8078
info@nevedanano.com
www.nevedanano.com