



SIM65M-EVB

User Guide

GNSS Module

SIMCom Wireless Solutions Limited.

SIMCom Headquarters Building, Building 3, No. 289 Linhong
Road, Changning District, Shanghai P.R. China

Tel: 86-21-31575100

support@simcom.com

www.simcom.com

Document Title:	SIM65M-EVB User Guide
Version:	V1.00
Date:	2022-07-21
Status:	Released

GENERAL NOTES

SIMCOM OFFERS THIS INFORMATION AS A SERVICE TO ITS CUSTOMERS, TO SUPPORT APPLICATION AND ENGINEERING EFFORTS THAT USE THE PRODUCTS DESIGNED BY SIMCOM. THE INFORMATION PROVIDED IS BASED UPON REQUIREMENTS SPECIFICALLY PROVIDED TO SIMCOM BY THE CUSTOMERS. SIMCOM HAS NOT UNDERTAKEN ANY INDEPENDENT SEARCH FOR ADDITIONAL RELEVANT INFORMATION, INCLUDING ANY INFORMATION THAT MAY BE IN THE CUSTOMER'S POSSESSION. FURTHERMORE, SYSTEM VALIDATION OF THIS PRODUCT DESIGNED BY SIMCOM WITHIN A LARGER ELECTRONIC SYSTEM REMAINS THE RESPONSIBILITY OF THE CUSTOMER OR THE CUSTOMER'S SYSTEM INTEGRATOR. ALL SPECIFICATIONS SUPPLIED HEREIN ARE SUBJECT TO CHANGE.

COPYRIGHT

THIS DOCUMENT CONTAINS PROPRIETARY TECHNICAL INFORMATION WHICH IS THE PROPERTY OF SIMCOM WIRELESS SOLUTIONS LIMITED COPYING, TO OTHERS AND USING THIS DOCUMENT, ARE FORBIDDEN WITHOUT EXPRESS AUTHORITY BY SIMCOM. OFFENDERS ARE LIABLE TO THE PAYMENT OF INDEMNIFICATIONS. ALL RIGHTS RESERVED BY SIMCOM IN THE PROPRIETARY TECHNICAL INFORMATION , INCLUDING BUT NOT LIMITED TO REGISTRATION GRANTING OF A PATENT , A UTILITY MODEL OR DESIGN. ALL SPECIFICATION SUPPLIED HEREIN ARE SUBJECT TO CHANGE WITHOUT NOTICE AT ANY TIME.

SIMCom Wireless Solutions Limited

SIMCom Headquarters Building, Building 3, No. 289 Linhong Road, Changning District, Shanghai P.R. China

Tel: +86 21 31575100

Email: simcom@simcom.com

For more information, please visit:

<https://www.simcom.com/download/list-863-en.html>

For technical support, or to report documentation errors, please visit:

<https://www.simcom.com/ask/> or email to: support@simcom.com

Copyright © 2021 SIMCom Wireless Solutions Limited All Rights Reserved.

Version History

Date	Version	Description of change	Author
2022.07.21	1.00	Origin	QIU LEI

Contents

1	Introduction	9
1.1	Features Overview	9
1.2	SIM65M-EVB Top and Bottom View	9
1.3	SIM65M Evaluation Kit	11
1.4	Interface Introduction	12
1.5	Power Supply	13
1.5.1	Power Supply	13
1.5.2	Separate Power Supply	14
1.6	UART Interface	14
1.7	Status Indicator Light	16
1.8	Buttons	16
1.9	Test Points	17
2	Operation Method	22
2.1	Module Boot	22
2.1.1	Module Power-on Operation	22
2.2	Driver Installation	22
2.2.1	USB-to-UART Driver Installation	22
2.3	SIMCom GPS Testing Tool	23
2.3.1	Port setting	23
2.3.2	Click to RUN	24

3	Appendix	26
	3.1 Reference Documents	26
	3.2 Terminology and Explanation	26
	3.3 Safety Warning	26

Table Index

Table 1: Main features	9
Table 2: Label information description	11
Table 3: EVB Kit	12
Table 4: EVB Kit	12
Table 5: Interface introduction	12
Table 6: micro USB interface pin definition (J401)	15
Table 7: Status indicator light description	16
Table 8: Buttons	17
Table 9: Test point description of J102 on EVB	18
Table 10: Pin description of location J105 on EVB	19
Table 11: The pin description of J301 on EVB	20
Table 12: The pin description of J302 on EVB	20
Table 13: USB to UART ports	22
Table 14: Reference documents	26
Table 15: Terminology and explanation	26
Table 16: Safety warning	26

Figure Index

Figure 1: SIM65M-EVB top view	10
Figure 2: SIM65M-EVB bottom view	10
Figure 3: SIM65M Evaluation kit	11
Figure 4: EVB Power supply block diagram	13
Figure 5: EVB power interface	13
Figure 6: Module power supply reference design	14
Figure 7: Module power supply separately (VCC_3.3V GND)	14
Figure 8: USB to UART reference design	15
Figure 9: micro USB interface pin definition (J401)	15
Figure 10: LED status indicator light (D303、D304)	16
Figure 11: Buttons	17
Figure 12: Test points location	18
Figure 13: The pin definition of J102 on EVB	18
Figure 14: Pin definition of location J105 on EVB	19
Figure 15: The pin definition of J301 on EVB	20
Figure 16: The pin definition of J302 on EVB	20
Figure 17: USB to UART ports	22
Figure 18: Testing tool interface	23
Figure 19: Setting Window	24
Figure 20: Click to Run	25

Figure 21: The module is running25

1 Introduction

The purpose of this article is to introduce the interface and usage of the development kit.

Based on the SIMCom development kit, developers will quickly become familiar with and verify the software functions of the module.

1.1 Features Overview

The main features of SIM65M-EVB are shown in the table below.

Table 1: Main features

Features	Description
Power supply	USB_VBUS: 5V power supply
UART interface	One USB-to-UART interface, as the main serial port for NMEA series output, data transmission, firmware upgrade and RTCM function
Signal indication	Two function indicator LED lights
Buttons	One button for power off and restart

1.2 SIM65M-EVB Top and Bottom View

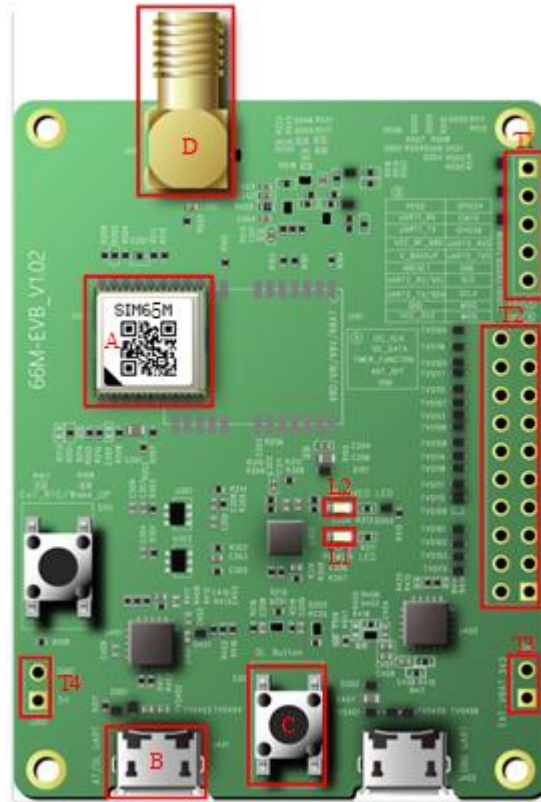

Figure 1: SIM65M-EVB top view

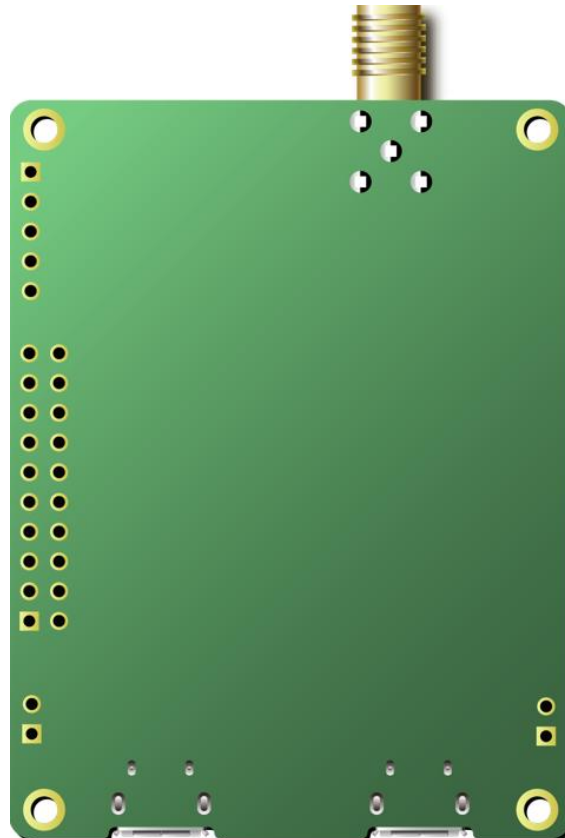

Figure 2: SIM65M-EVB bottom view

Table 2: Label information description

Label information	Description
A	SIM65M Module
B	Dual serial port are used as the main serial port for NMEA series output, data transmission, firmware upgrade and RTCM function
C	Restart after power failure
D	GNSS antenna connector
L1	Power indicator light
L2	PPS indicator light
T1,T2,T3,T4	Test point

1.3 SIM65M Evaluation Kit

Evaluation kit includes EVB board and other accessories.

The SIM65M kit list is as follows, please ensure that all kits are complete.

- 1) SIM65M-EVB board;
- 2) MICRO USB data cable; 5
- 3) GPS/ Beidou/Galileo/Glonass Ceramic Active Module Antenna;

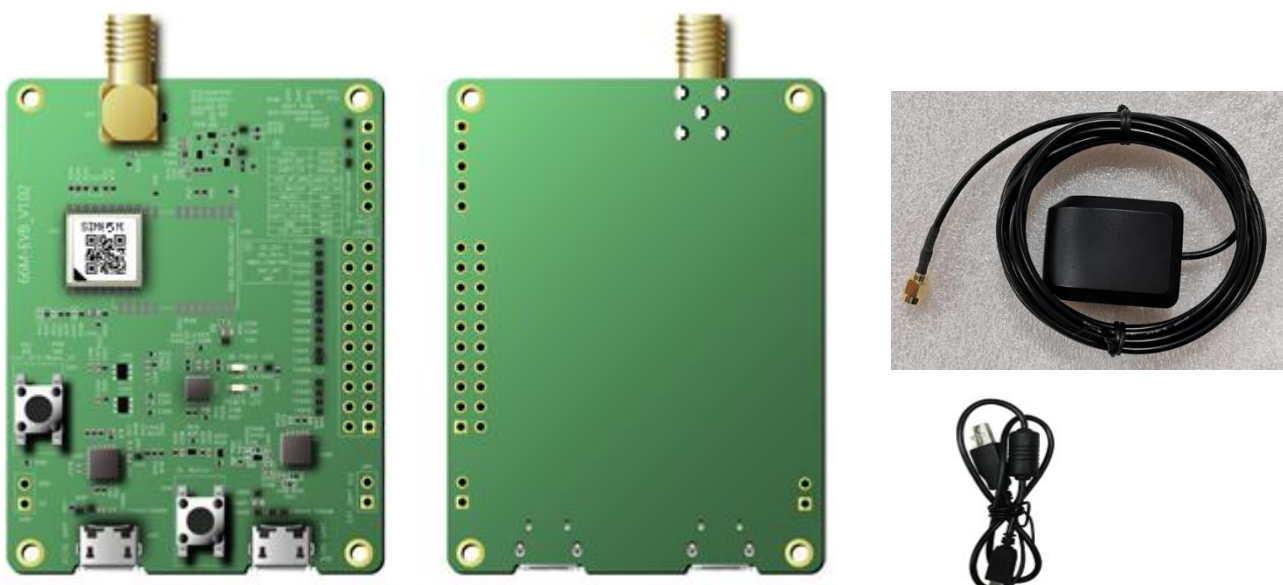

Figure 3: SIM65M Evaluation kit

Table 3: EVB Kit

EVB Kit	Description	quantity
SIM65M-EVB	EVB board	1
Antenna	GPS/Beidou/Galileo/Glonass Ceramic Active Module Antenna	1
MICRO USB data cable	MICRO USB data cable	1

To ensure that the module can be used normally, it is recommended to use the correct kit model. The part numbers of SIM65M-EVB kit are shown in the table below.

Table 4: EVB Kit

EVB Kit	Part No
SIM65M-EVBKIT	S2-10C93

1.4 Interface Introduction

The interface of SIM65M-EVB is shown in the table below.

Table 5: Interface introduction

Function	Reference number	Description
UART	J401	J401: NMEA series output, data transmission and firmware upgrade
LEDs	D303	D303: Power status indicator light
	D304	D304: PPS signal indicator light
Buttons	S301	S301: Power off and restart
Test points	J102 J105 J301 J302	J301 J302: Power test point
		J102 J105: Module signal test point

More detailed introductions about the above functions are shown in the next section.

1.5 Power Supply

1.5.1 Power Supply

SIM65M-EVB is powered by micro USB, USB plug-in connection device J401 can achieve 5V power supply.

The power supply block diagram of SIM65M-EVB is shown in the figure below.

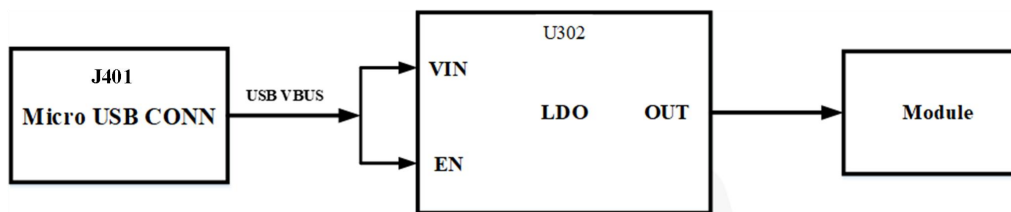

Figure 4: EVB Power supply block diagram



Figure 5: EVB power interface

1.5.2 Separate Power Supply

The module power supply reference design is shown in the figure below.

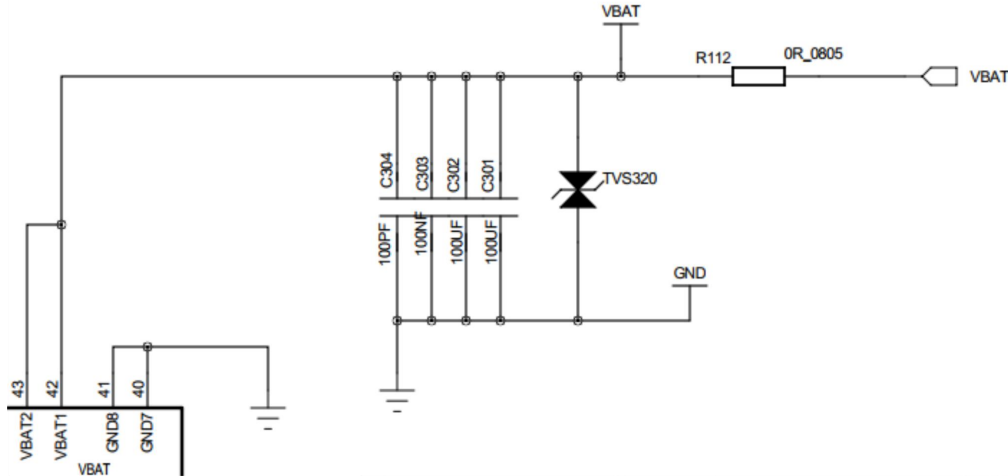

Figure 6: Module power supply reference design

The test points of VCC_3.3V and GND of the module are shown in the figure below. If the module needs to be powered separately, the resistance of R312 should be removed first, and then the J301 pin 2 VCC_3.3V and J302 pin 1 GND test points should be externally supplied with power.

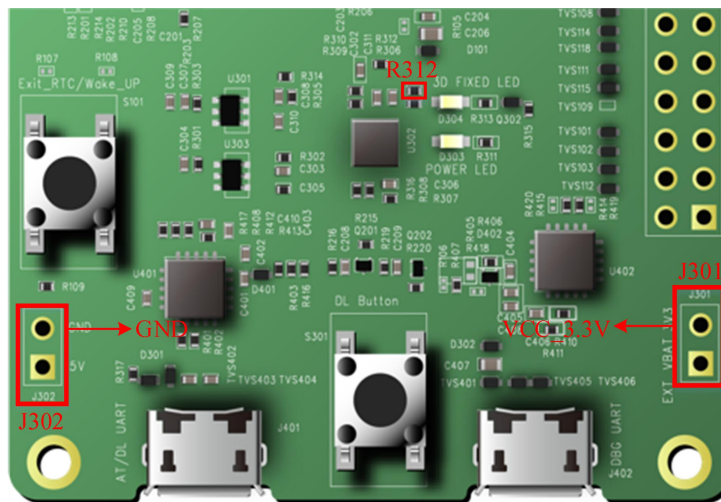

Figure 7: Module power supply separately (VCC_3.3V GND)

1.6 UART Interface

SIM65M-EVB provides one UART interface J401 by USB to UART. The J401 provides the dual serial port:

Enhanced COM port and Standard COM port. Enhanced COM port is used as the main serial port for NMEA series output, data transmission and firmware upgrade. Standard COM port is used as RTCM function.

The reference circuit of USB to UART interface is shown in the figure below.

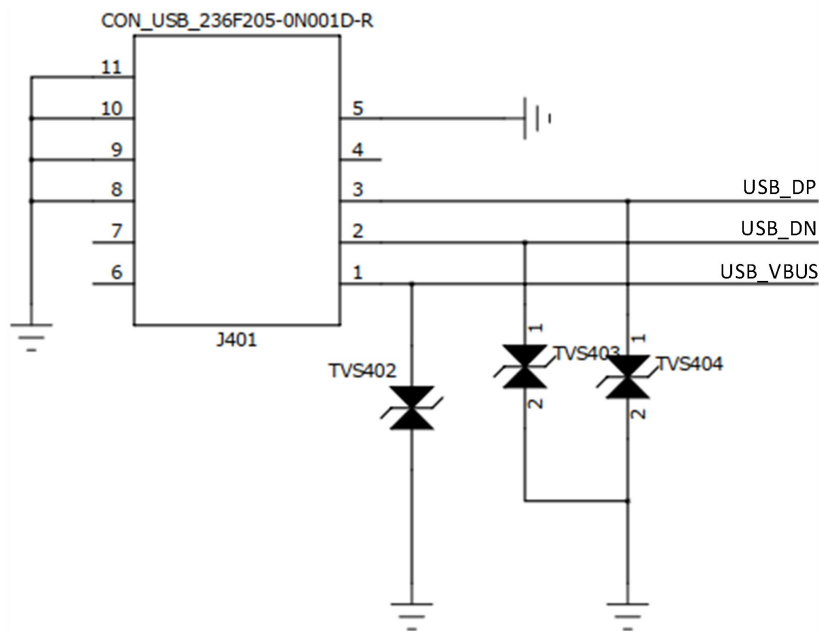

Figure 8: USB to UART reference design

The pin definition of the Micro USB interface is shown in the figure below.

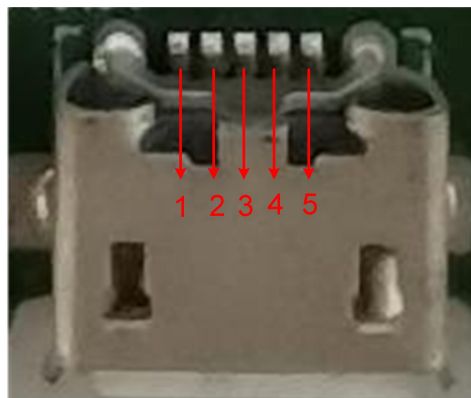

Figure 9: micro USB interface pin definition (J401)

Table 6: micro USB interface pin definition (J401)

Pin number	Pin name	I/O	Description
1	VBUS	O	USB power supply
2	USB_DN	I/O	USB differential data negative (USB-to-UART)
3	USB_DP	I/O	USB differential data positive (USB-to-UART)
4	\	\	Float

5	GND	\	Ground
---	-----	---	--------

1.7 Status Indicator Light

There are two status indicator lights D303 and D304 for function indication on SIM65M-EVB.

The status indicators D303 and D304 are as shown in the figure below.

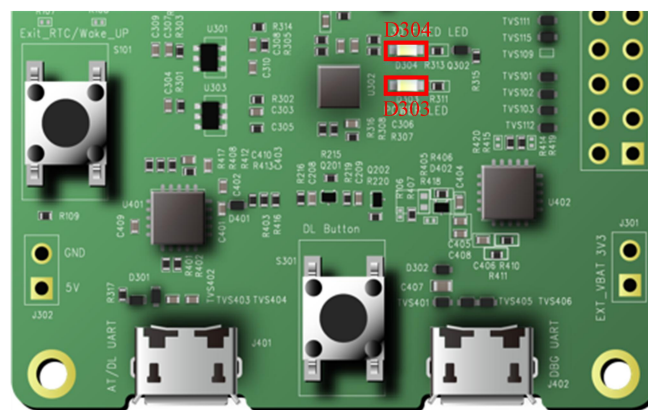

Figure 10: LED status indicator light (D303、D304)

Table 7: Status indicator light description

LEDs number	LEDs Colour	Description
D303	Red	Power status indicator light
D304	Blue	PPS signal indicator light

1.8 Buttons

There have one button (S301) on SIM65M-EVB, the S301 is used for power off and restart.

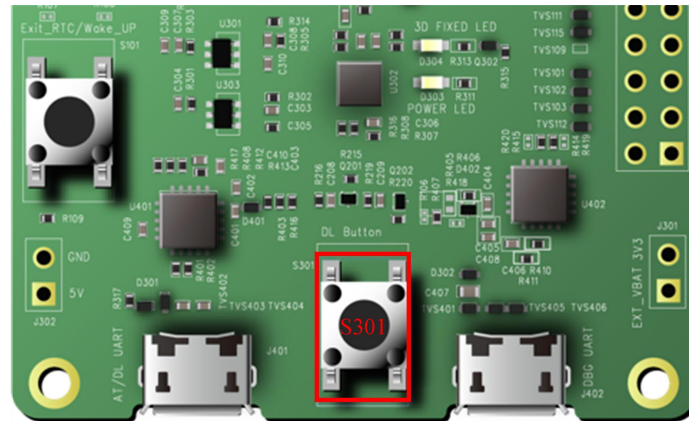

Figure 11: Buttons

Table 8: Buttons

Number	Name	Description
S301	DL Button	Used to power off and restart

1.9 Test Points

There are four sets of test points J102、J105、J301 and J302 on SIM65M-EVB. The details of the test points are as follows.

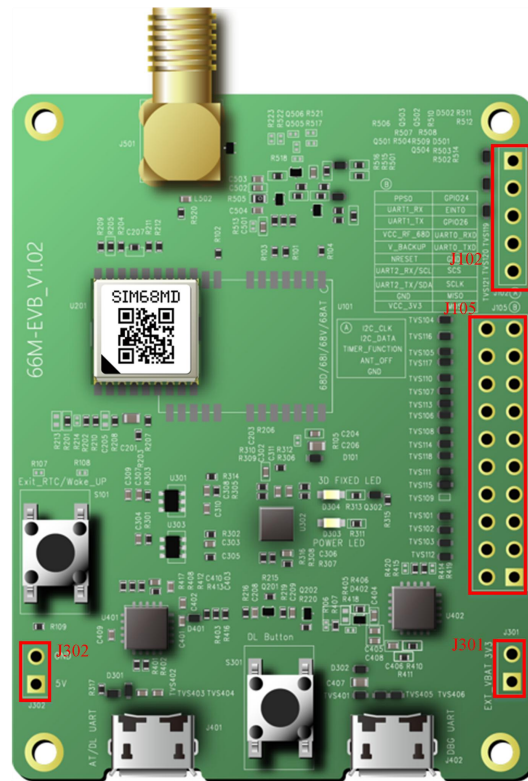

Figure 12: Test points location

The pin definition of position J102 is shown in the figure below.

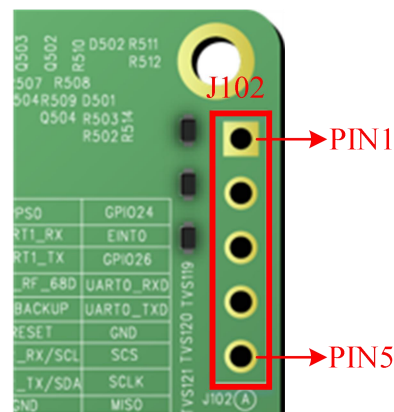

Figure 13: The pin definition of J102 on EVB

Table 9: Test point description of J102 on EVB

Position	Number	Name	Description
J102	J102_PIN1	I2C_CLK	I2C clock signal
	J102_PIN2	I2C_DATA	I2C data signal
	J102_PIN3	TIMER_FUNCTION	TIMER_FUNCTION outputs timing pulse related to receiver time
	J102_PIN4	ANT_OFF	SIM65M antenna power supply control output

J102_PIN5	GND	Ground
-----------	-----	--------

The pin definition of position J105 is shown in the figure below.

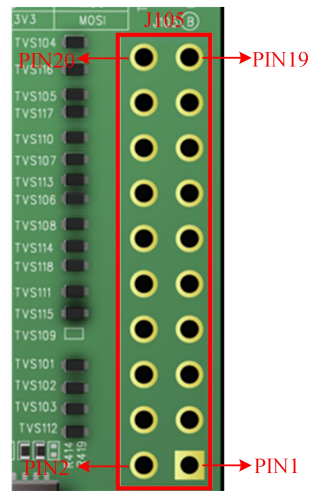

Figure 14: Pin definition of location J105 on EVB

Table 10: Pin description of location J105 on EVB

Position	Test point	Signal name	Description
J105	J105_PIN1	MOSI	SPI Master output signal
	J105_PIN2	VCC_3.3V	Module 3.3V power supply
	J105_PIN3	MISO	SPI Master input signal
	J105_PIN4	GND	Ground
	J105_PIN5	SCLK	SPI Clock output signal
	J105_PIN6	UART2_TX/SDA	RTCM function and NMEA serial output or I2C data signal
	J105_PIN7	SCS	SPI Chip select signal
	J105_PIN8	UART2_RX/SCL	RTCM function and NMEA serial input or I2C clock signal
	J105_PIN9	GND	Ground
	J105_PIN10	NRESET	SIM65M reset signal, pull down this signal to restart the module
	J105_PIN11	UART0_TX	NMEA serial output
	J105_PIN12	V_BACKUP	The backup battery input power supply for RTC
	J105_PIN13	UART0_RX	NMEA serial input
	J105_PIN14	VCC_RF_68D	SIM65M 2.8V output power supply for active antenna
	J105_PIN15	GPIO26	Module wake-up signal, this pin is SIM68D module
	J105_PIN16	UART1_TX	System LOG serial output

J105_PIN17	EINT0	RTC interrupt , Exit RTC mode, this pin is SIM68D module
J105_PIN18	UART1_RX	System LOG serial input
J105_PIN19	GPIO24	Host device wakeup the module from sleep mode, active high
J105_PIN20	PPSO	PPS outputs timing pulse related to receiver time

The pin definition of J301 is shown in the figure below.

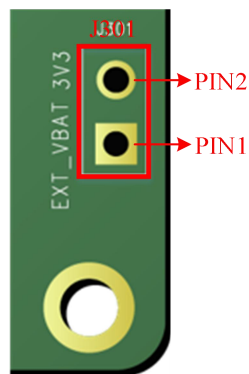

Figure 15: The pin definition of J301 on EVB

Table 11: The pin description of J301 on EVB

Position	Test point	Signal name	Description
J301	J301_PIN1	EXT_VBAT	EVB LDO power supply output voltage test point
	J106_PIN2	VCC_3V3	Module power input voltage test point

The pin definition of J302 is shown in the figure below.

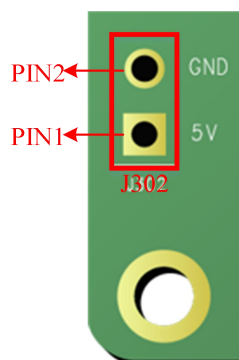

Figure 16: The pin definition of J302 on EVB

Table 12: The pin description of J302 on EVB

Position	Test point	Signal name	Description
J302	J302_PIN1	5V	EVB 5V power supply test point
	J302_PIN2	GND	GND

NOTE

1. For the related functions of each pin of the module, please refer to document [1].

2 Operation Method

2.1 Module Boot

2.1.1 Module Power-on Operation

The module boot method is as follows:

Insert the Micro USB into the USB connector J401, and the module is powered on and automatically starts, and the D303 will light up.

2.2 Driver Installation

2.2.1 USB-to-UART Driver Installation

The following connection can get the USB to UART driver.

<https://www.silabs.com/products/development-tools/software/usb-to-uart-bridge-vcp-drivers>

After the driver is successfully installed, the following virtual serial port will appear: Enhanced COM Port and Standard COM Port.



- ▼ Port COM and PLT
 -  Silicon Labs Dual CP2105 USB to UART Bridge: Enhanced COM Port (COM4)
 -  Silicon Labs Dual CP2105 USB to UART Bridge: Standard COM Port (COM3)
 -  Communication Port

Figure 17: USB to UART ports

Table 13: USB to UART ports

Reference Number	Interface type	Port number	Serial port	Function description
------------------	----------------	-------------	-------------	----------------------

J401	ECI	COM4	Enhance UART	Used for AT communication, data transmission and firmware upgrade
	SCI	COM3	Standard UART	Used for AT communication, data transmission and firmware upgrade

2.3 SIMCom GPS Testing Tool

Please contact SIMCom to get the newest version of GPS Testing tool.

2.3.1 Port setting

The interface of the test tool is shown in the following figure.

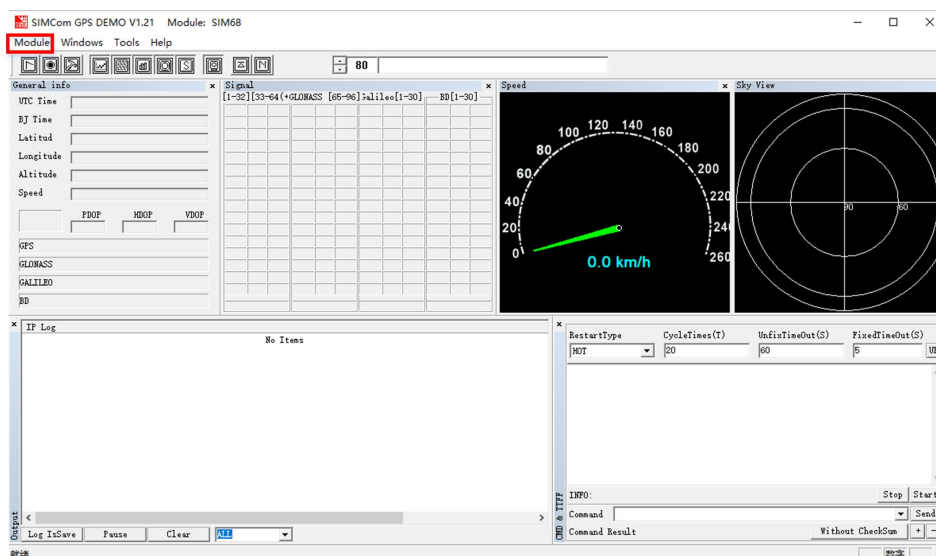

Figure 18: Testing tool interface

In the testing tool interface, open the “setting” window according to the following path: Module→Properties. Interface setting procedure:

- (1) Select the module:SIM68, because the SIM65M-EVB compatible with SIM68MD EVB;
- (2) Select the NMEA COM: Enhanced COM Port;
- (3) Select the baudrate:115200;
- (4) Click OK .

The setting procedure is shown in the following figure.

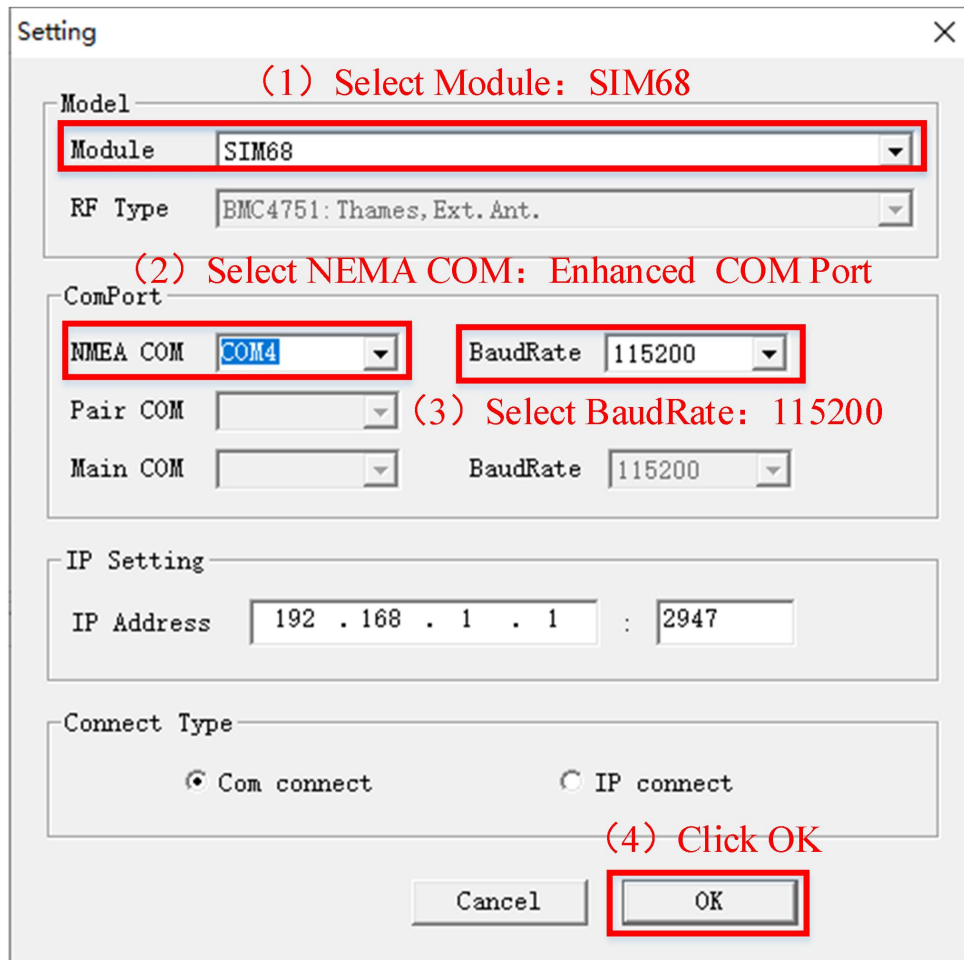

Figure 19: Setting Window

2.3.2 Click to RUN

Click the button "Run Comport" on the up left to run the module.

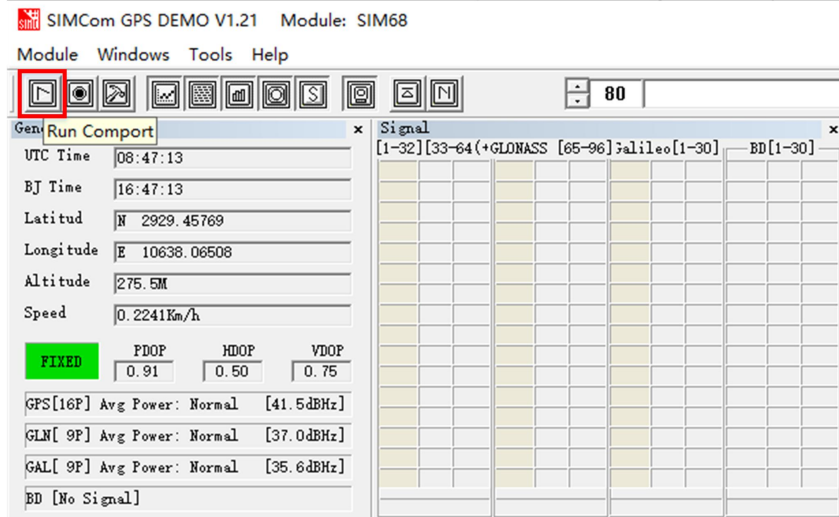

Figure 20: Click to Run

The module will run as the following figure.

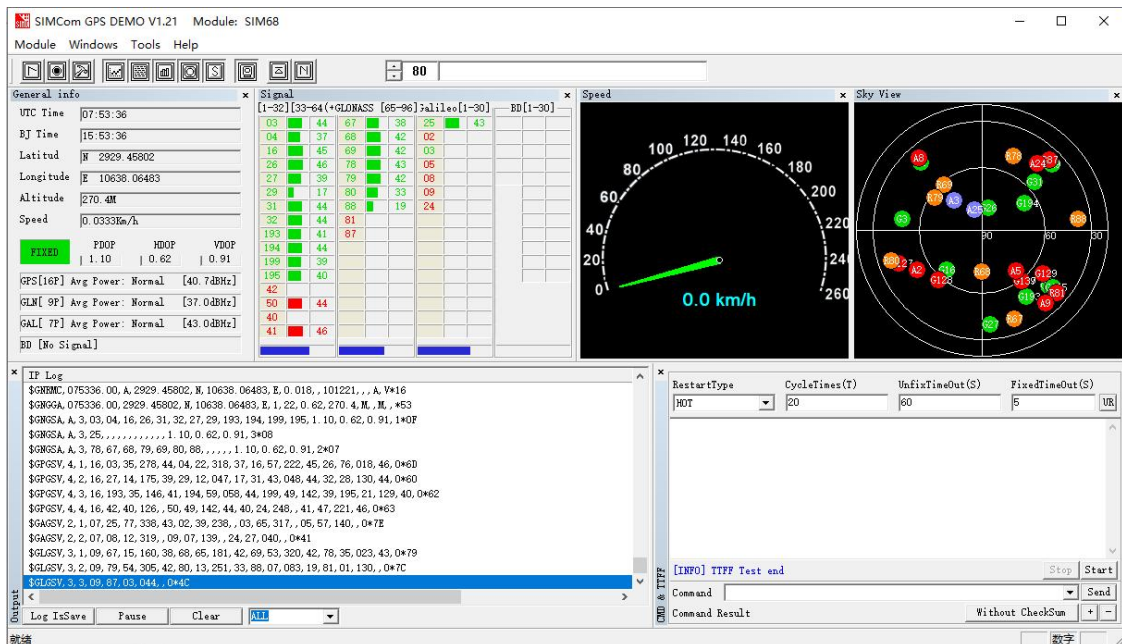

Figure 21: The module is running

3 Appendix

3.1 Reference Documents

Table 14: Reference documents

Number	File name	Describe
[1]	SIM65M Hardware Design	SIM65M Hardware Design Manual

3.2 Terminology and Explanation

Table 15: Terminology and explanation

Terminology	Explanation
EVB	Evaluation Board
UART	Universal Asynchronous Receiver Transmitter
LED	Light Emitting Diode
NMEA	National Marine Electronics Association
NC	Not connect
GPS	Global Positioning System

3.3 Safety Warning

Table 16: Safety warning

Marks	Requirements
	When in a hospital or other health care facility, observe the restrictions about the



use of mobiles. Switch the cellular terminal or mobile off, medical equipment may be sensitive and not operate normally due to RF energy interference.



Switch off the cellular terminal or mobile before boarding an aircraft. Make sure it is switched off. The operation of wireless appliances in an aircraft is forbidden to prevent interference with communication systems. Forgetting to think much of these instructions may impact the flight safety, or offend local legal action, or both.



Do not operate the cellular terminal or mobile in the presence of flammable gases or fumes. Switch off the cellular terminal when you are near petrol stations, fuel depots, chemical plants or where blasting operations are in progress. Operation of any electrical equipment in potentially explosive atmospheres can constitute a safety hazard.



Your cellular terminal or mobile receives and transmits radio frequency energy while switched on. RF interference can occur if it is used close to TV sets, radios, computers or other electric equipment.



Road safety comes first! Do not use a hand-held cellular terminal or mobile when driving a vehicle, unless it is securely mounted in a holder for hands free operation. Before making a call with a hand-held terminal or mobile, park the vehicle.



GSM cellular terminals or mobiles operate over radio frequency signals and cellular networks and cannot be guaranteed to connect in all conditions, especially with a mobile fee or an invalid SIM card. While you are in this condition and need emergent help, please remember to use emergency calls. In order to make or receive calls, the cellular terminal or mobile must be switched on and in a service area with adequate cellular signal strength.

Some networks do not allow for emergency call if certain network services or phone features are in use (e.g. lock functions, fixed dialing etc.). You may have to deactivate those features before you can make an emergency call.

Also, some networks require that a valid SIM card be properly inserted in the cellular terminal or mobile.