

REV.	ECN NO.	LOCATIONS.	DESCRIPTION	DATE	CHANGER
A			新版本	2011-05-24	陈雄军

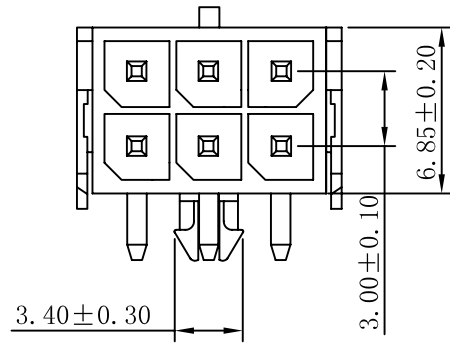

2*1-2*3P

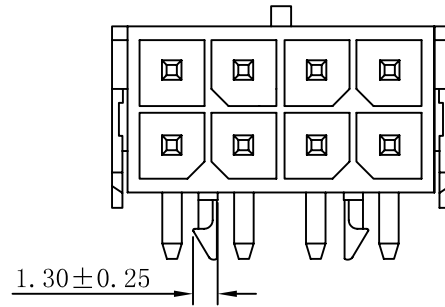

2*4-2*12P

■ SPECIFICATIONS

- Voltage rating: 250V AC, DC
- Current rating: 5A, AC, DC
- Withstanding Voltage: 1500V AC/minute
- Insulation resistance: 1000MΩ min
- Temperature range: -25° C~+85° C
- Contact resistance: 10mΩ max

■ WAFER

- Poles : 02-24
- Material: Nylon 66 15%GF UL94V-0 Black
- Pin Material: Brass /Tin-plated

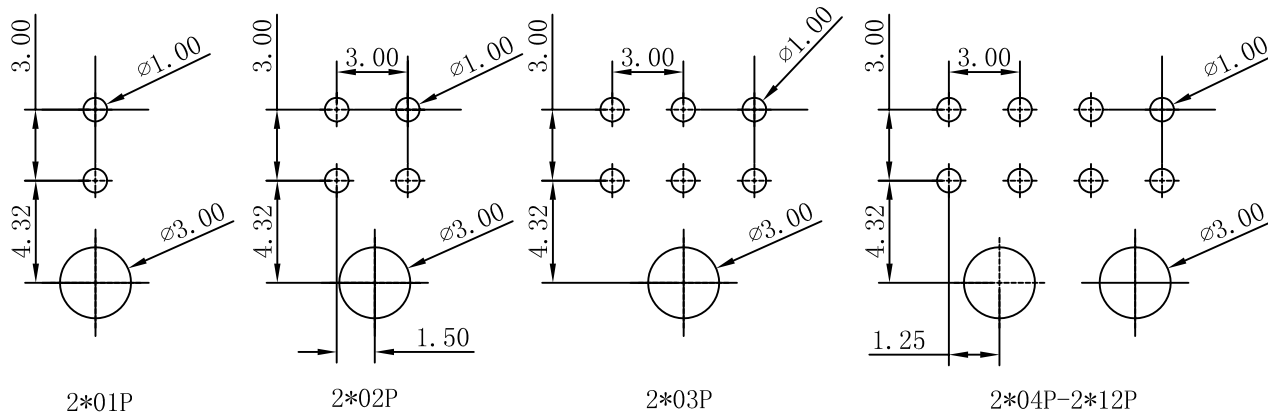
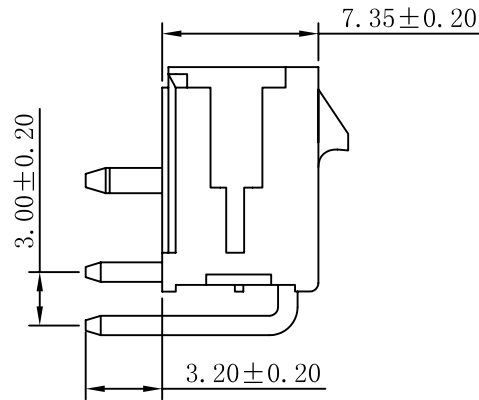
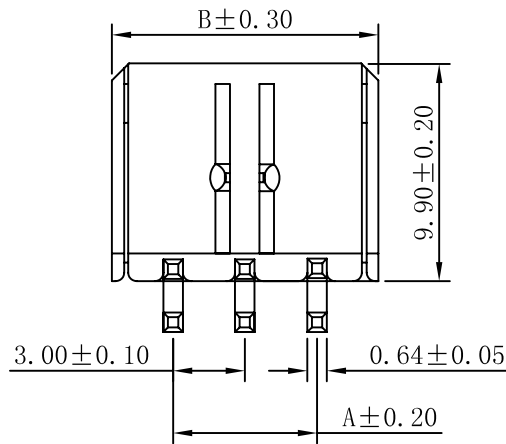

P. C. B. LAYOUT

PIN NO.	Dimensions (mm)	
	A	B
2*01	--	6.65
2*02	3.00	9.65
2*03	6.00	12.65
2*04	9.00	15.65
2*05	12.00	18.65
2*06	15.00	21.65
2*07	18.00	24.65
2*08	21.00	27.65
2*09	24.00	30.65
2*10	27.00	33.65
2*11	30.00	36.65
2*12	33.00	39.65

Conntherm			TOLERANCE	
			0±0.30	
TITLE			成品规格图	
CHECKED BY			DATE	SCALE
胡进			2013-6-01	1:1
DRAWN BY			UNIT: mm	VER NO.
陈雄军			PART NO.	SIZE
				A
				A4

REV.	ECN NO.	LOCATIONS.	DESCRIPTION	DATE	CHANGER
A			新版本	2011-05-24	陈雄军

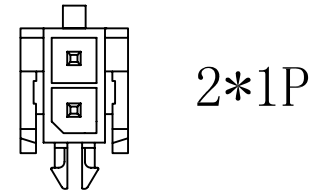
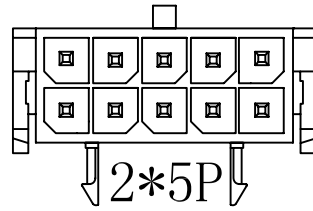
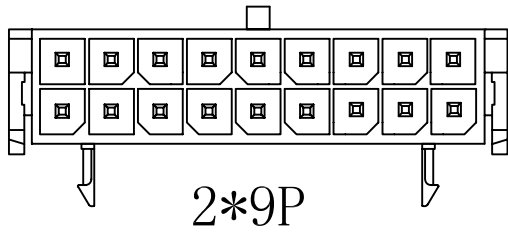
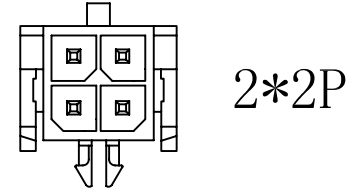
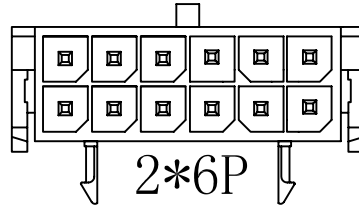
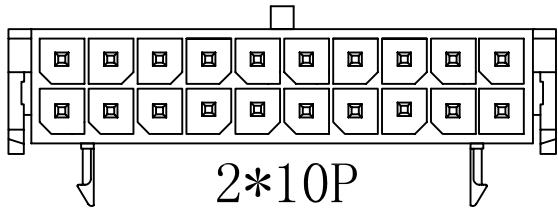
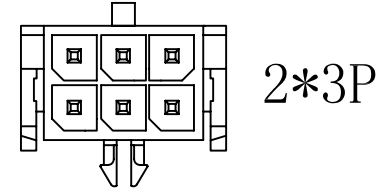
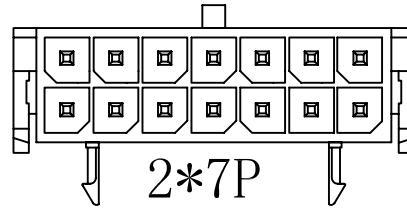
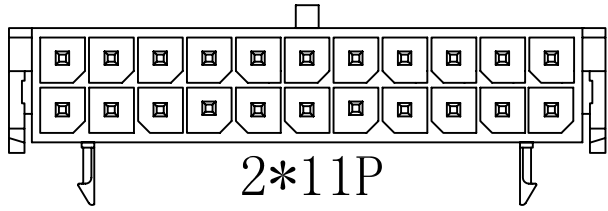
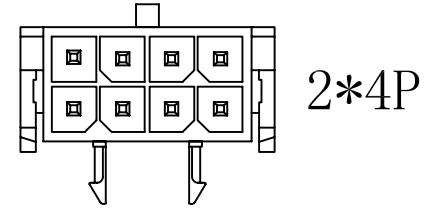
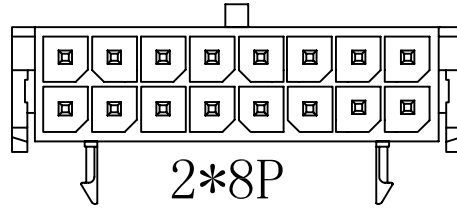
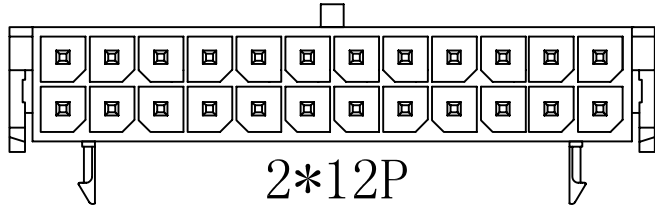

Conntherm			TOLERANCE	
			0±0.30	
TITLE	成品规格图		.0±0.25	
			.00±0.20	
CHECKED BY	DATE	SCALE	.000±0.015	
	2012-05-15	1:1	VER NO.	SIZE
DRAWN BY	UNIT: mm		A	A4
陈雄军	PART NO.			