

Quartz Crystal



SERIES 6I GLASS SEALED CERAMIC5*3.2mm 2PAD SURFACE MOUNT PACKAGE

Approved by:
Checked by:
Issued by:

SPECIFICATION

MODEL: SJK-6I-24.00-16-30-60-F-B-30

深圳市晶科鑫实业有限公司
SHENZHEN CRYSTAL TECHNOLOGY INDUSTRIAL CO., LTD.

Add: RM#1805, East Wing, TianAn Hi-tech Plaza Phase2, TianAn Cyber Park Shenzhen, China
Tel: (86) 755 88352809 88352810 Fax: (86) 755 88353718 88352499
E-mail: jolly@q-crystal.com HTTP://www.q-crystal.com

Quartz Crystal



SERIES 6I GLASS SEALED CERAMIC5*3.2mm 2PAD SURFACE MOUNT PACKAGE

FEATURE

- I Ultra thin,thickness 1.0mm
- I Leadiess. type
- I High precision characteristic covering up high frequency range.
- I Automatic mounting
- I Emboss taping specification.
- I Suitable for reflow soldering
- I Available on tape and reel ,1000pcs per reel

APPLICATIONS

- I Ideally suited designed for disc drives, NB,PCs and hand-held electronic products

ELECTRICAL SPECIFICATIONS

Output Frequency Range	24.00MHz
Mode	Fundamental / AT
Frequency Tolerance (at 25°C)	±30ppm
Frequency Stability Over Operating Temperature Characteristics	±30ppm
Storage Temperature Range	-40 °C to +85 °C
Operating Temperature Range	-20 °C to + 70 °C
Shunt Capacitance (C ₀)	5.0 pF Max
Driver Level (Typical)	10μW
Load Capacitance(C _L)	16pF
Equivalent Series Resistance ESR (Ω)	60Ω
Aging @25°C 1 st year (Max)	±3ppm/year
Shock Resistance	Drop test of 3 times on 2mm stainless plate from 75cm height

REMARK: SPECIFICATIONS SUBJECT TO CHANGE WITHOUT PRIOR NOTICE. PLEASE CONFIRM WITH OUR SALES ENGINEER.

PART NUMBER

SJK-	24.00M	—	16	—	30	—	60	—	B	—	30
6I-	Frequency		Load capacitance e.g. 16: 16pf s:series		Frequency tolerance e.g. 30: ±30ppm		E.S.R.max e.g. 60:60Ωmax		Operating temperature range A:-10-60°C B:-20-70°C C:-40-85°C		Temperature stability: e.g. 30:±30ppm

Add: RM#1805, East Wing, TianAn Hi-tech Plaza Phase2, TianAn Cyber Park Shenzhen, China
 Tel: (86) 755 88352809 88352810 Fax: (86) 755 88353718 88352499
 E-mail: jolly@q-crystal.com HTTP://www.q-crystal.com

Quartz Crystal



SERIES 6I GLASS SEALED CERAMIC 5*3.2mm 2PAD SURFACE MOUNT PACKAGE

Dimension

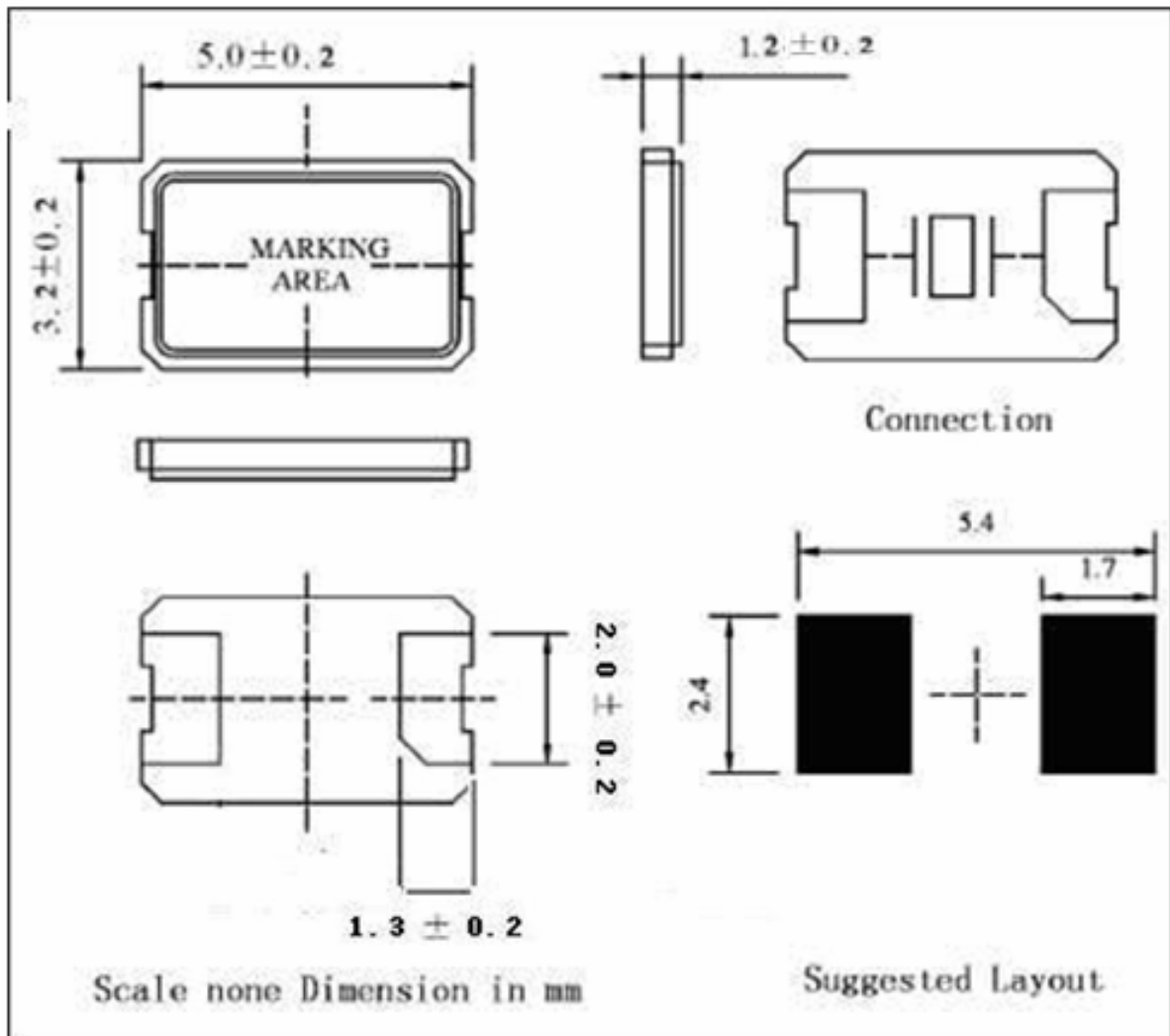

Reflow Condition

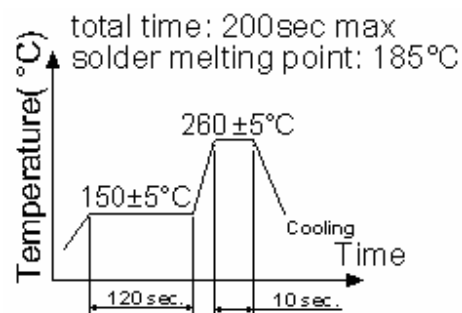

Add: RM#1805, East Wing, TianAn Hi-tech Plaza Phase2, TianAn Cyber Park Shenzhen, China
Tel: (86) 755 88352809 88352810 Fax: (86) 755 88353718 88352499
E-mail: jolly@q-crystal.com HTTP://www.q-crystal.com

Quartz Crystal



SERIES 6I GLASS SEALED CERAMIC 5*3.2mm 2PAD SURFACE MOUNT PACKAGE

PACKING

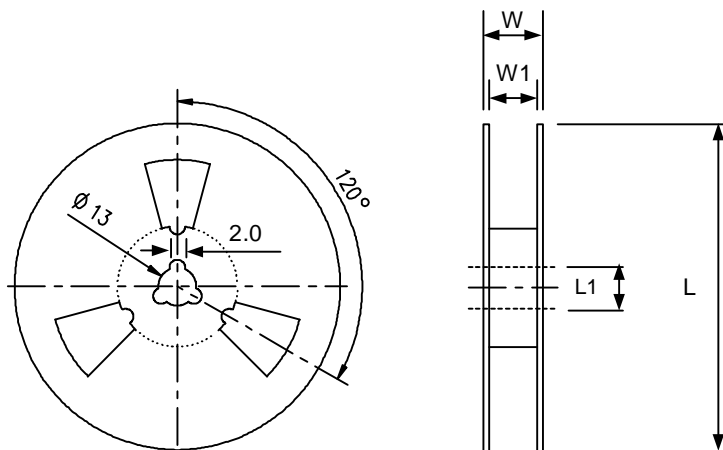
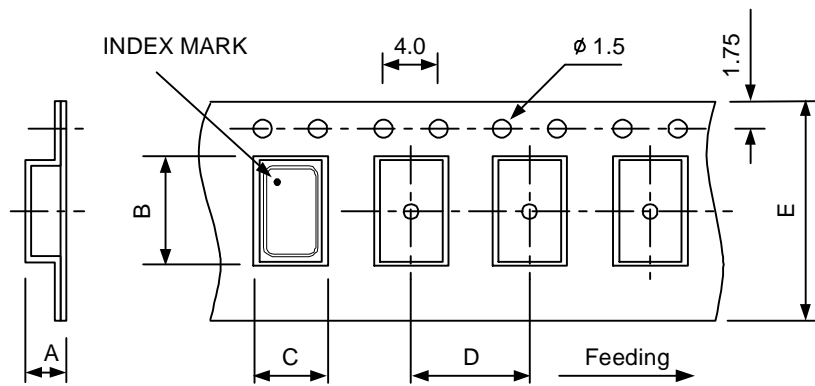

DIMENSIONS	A	B	C	D	E	L	L1	W	W1	pcs / Reel	
	7050	2.15	7.9	5.4	8.0	16	180	13	21.5	17.5	1K
	6035	1.4	6.4	3.9	8.0	12	180	13	15.4	13	
	5032	1.46	5.5	3.6	8.0	12	180	13	15.4	13	
	3225	1.4	3.4	2.7	4	8	178	13	11.5	8	3k

Add: RM#1805, East Wing, TianAn Hi-tech Plaza Phase2, TianAn Cyber Park Shenzhen, China
 Tel: (86) 755 88352809 88352810 Fax: (86) 755 88353718 88352499
 E-mail: jolly@q-crystal.com HTTP://www.q-crystal.com

RELIABILITY TEST SPECIFICATION

Test item	Equipment	Condition	Specification
1. SOLDERABILITY TEST	TBAEI ESPEC(K-1425-14D)	Welding can be temperature: 260 ± 5 °C, 5' s(125 °C, 120 SEC preheating Anti-welding temperature: 260 ± 5 °C, soaking time: 10 seconds	MIL-STD-883E Method 2003.7
2. HERMETICITY TEST	Helium leak detectors	1. Small leak: 4.5 KGF/CM2 2hours1 * 10-9-9 PA.M3/SEC crude leak: 4.5KGF/CM2 2hours1.5 * 10-5 PA.M3/SEC	MIL-STD-883E Method 1014.10
3. VIBRATION TEST	Sweep vibration test machines (1MV CO. (VS-300-2)), S & A250B	1 Crystal on 10-2000 Hz, X, Y, Z water level, each 20-minute vibration, a test every four hours, then the sample used to test 250 b	MIL-STD-883E Method 2007.3
4. MECHANICAL SHOCK	TOOL	A high degree of crystal from 150 CM to 150 g of three directions from the direction of impact X.Y.Z3 work hard wooden board	JIS C6701
5. MECHANICAL IMPACT TEST	TOOL	c1000G, 0.5Msec, 3, from the X, Y, Z three-day direction of hard wood boards, then the sample used to test 250 B	MIL-STD-202F Method 213B
6. DROP TEST	Fell hard wood equipment, S & A 250B	Crystal 75 cm in height, falling three times in the hard wooden board	JIS C6701
7. SALT SPRAY	H-SST-60、RC-328A	5% NaCL (sodium carbonate), 35 ± 2 °C temperature of the box, 48 hours, PH value: 6.5 to 7.2	
8. HIGH&LOW TEMP STORAGE TEST	TABEL ESPEC(MC-810), S&A 350B/250B	High temperature: 125 ± 2 °C, 500 hours; low temperature: -40 ± 3 °C, 500hours	MIL-STD-883E Method 1005.8
9. TEMP & HUM CYCLING TEST	TABEI ESPEC (TPC-211) S&A350B/250B	Temperature: $121 + / -3$ °C RH100% 2BAI, 240hours	JIS C6701
10. HIGH TEM. & HUM. STORAGE TEST	TBAEL ESPEC (PH-3F) , S&A350B/250B	Temperature: 40 ± 2 , Humidity: 85 +3, -2%, storage 96 hours	JIS C5023
11AGING TEST	PRA(2360)	Temperature: 85 ± 3 °C, 1000hours	JIS C6701