

LL01ED-AJxxL Data Sheet

For CREE Multi-Color and Single-Color LEDs



Features:

- High efficiency
- Available in 3 beam Patterns
- Optimized for uniform effects
- Lens without Housing

Typical applications :

- Stage Lighting
- Street Lights
- Decorative Light
- Architectural Lighting
- Down Light

Table of Contents

General Information.....	2
General Specifications.....	2
Optical Specifications.....	3
Mechanical Specifications.....	4
Illumination charts.....	5
Package Specifications.....	6
Product Nomenclature.....	7

General Information

- **Compatible Led Type :**

The LL01ED-AJxxL Single lens are optimized for both Multi-Color R.G.B CREE LEDs and Single-Color Cree LEDs (Cree MC-E White)from Cree Opto.⁽¹⁾

- **Beam Angle Type :**

An optimized profile integrate different front shape enable the generation of three lens models : smallest medium(25deg);medium beam (40deg);biggest beam(60deg).⁽²⁾

- **The Way to Assembly :**

The Lens should be assembled to the PCB board or MCPCB upon LEDs which provides the most appropriate related position, so as to achieve the best uniform results

*** Manually installation or if necessary thermal glue are recommended.**

- **Function :**

LL01ED-AJxxL provides exceptional color mixing result with the highest efficiency through careful engineering and precision manufacturing process.

General Specifications

- Lens Material Optical Grade PMMA PC
- Operating Temperature range -40°C ~ + 70°C (upper limit +80°C)
- Storage Temperature range -40°C ~ + 70°C (upper limit +80°C)

*Average transmittance in visible spectrum 400nm~700nm > 90%

Notes:

(1) Cree MC-E is a trademark of Cree,Inc , for technical information on LEDs, please refer to Cree,Inc, www.cree.com/xlamp.

(2) Typical beam divergence will be affected by different color of LEDs.

Optical Specifications [Typical beam Angle and intensity (cd/lm) of LL01 lens]

• CREE MC-E LED

Typical Cone Angle (degree) ⁽³⁾ with CREE MC-E			
Part Number	Red LEDs	Green LEDs	Blue LEDs
LL01ED-AJ25L	--	--	--
LL01ED-AJ40L	--	--	--
LL01ED-AJ60L	--	--	--

The typical cone angle measures where the luminous intensity is 90% of the peak value of intensity. This typical cone varies with LED color due to different chip size and chip position tolerance.

Typical on axis intensity (cd/lm) ⁽⁴⁾ with CREE MC-E			
Part Number	Red LEDs	Green LEDs	Blue LEDs
LL01ED-AJ25L	--	--	--
LL01ED-AJ40L	--	--	--
LL01ED-AJ60L	--	--	--

Luminous intensity depends on the flux binning and tolerance of the LEDs. Please refer to the LEDs data sheet for more details on Flux binning and mechanical tolerance.

• CREE MC-E LED

Typical Cone Angle (degree) ⁽³⁾ with CREE MC-E			
Part Number	White LEDs	Warm white LEDs	
LL01ED-AJ25L	47	49	
LL01ED-AJ40L	57	52	
LL01ED-AJ60L	59	60	

The typical cone angle the full angle measured where the luminous intensity is 90% of the peak value of intensity. That typical cone varies with LED color due to different chip size and chip position tolerance.

Typical on axis intensity (cd/lm) ⁽⁴⁾ with CREE MC-E			
Part Number	White LEDs	Warm white LEDs	
LL01ED-AJ25L	1520	1100	
LL01ED-AJ40L	1280	900	
LL01ED-AJ60L	840	500	

Luminous intensity depends on the flux binning and tolerance of the LEDs. Please refer to the LEDs data sheet for more detail on Flux binning and mechanical tolerance

Notes:

(3) The typical divergence will be changed by different color, chip size and chip position tolerance. The typical total divergence is the full angle measured where the luminous intensity is half of the peak value.

(4) The efficiency value listed above is the total value of the whole lens model, the value depends on the total flux of the LED used. Luminous intensity depends on the LEDs flux and its tolerances, for more details of LED flux, please check Cree data sheet at www.cree.com.

Mechanical Specifications

• Usage and Maintenance :

1. If necessary, clean lenses with mild soap, water and soft cloth
2. Never use any commercial cleaning solvents on lenses, like alcohol
3. Please handle or install lenses with wearing gloves, skin oils may damage lens or its optical characteristic.

1. Lens + Leds+MCPCB assembly instruction

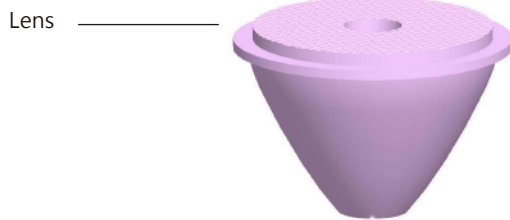

2. View assembly lens with MCPCB:

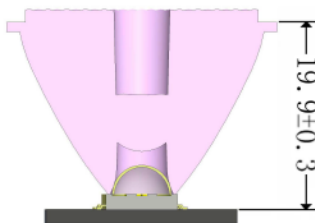

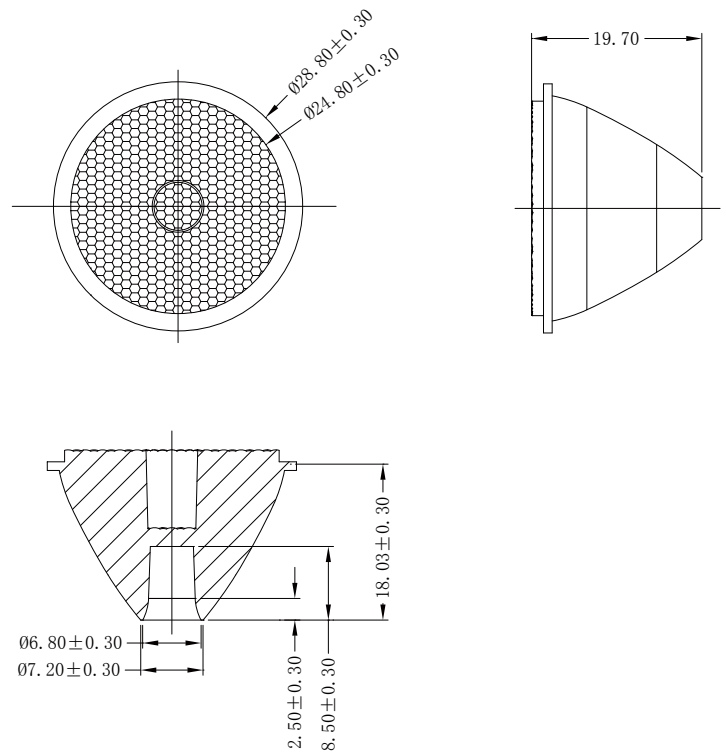

3. Lens dimensions and Top Views:



- Notes:
- (1) All dimensions are in mm.
 - (2) Drawing not to scale.
 - (3) Collimator material is PMMA.

Illumination charts

*CREE single white LED: CREE MC-E

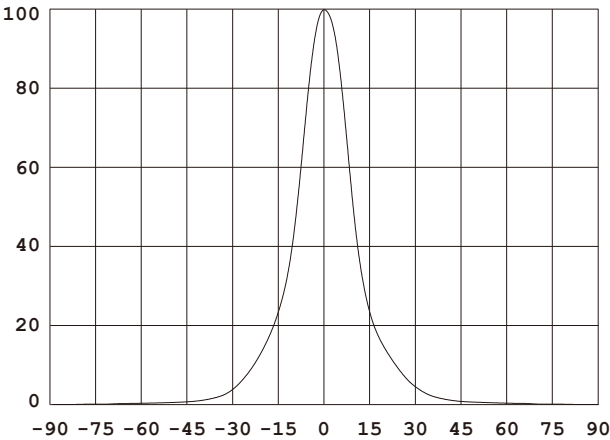
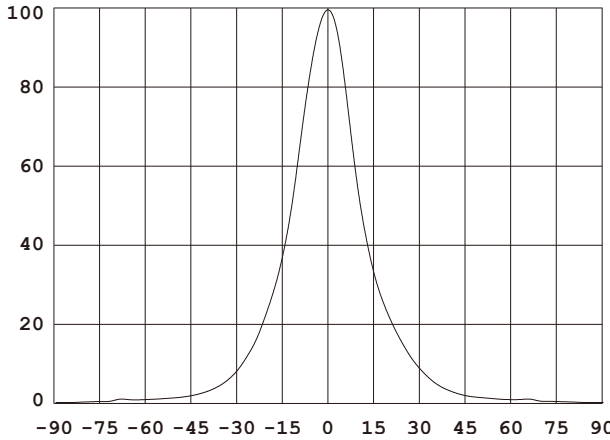
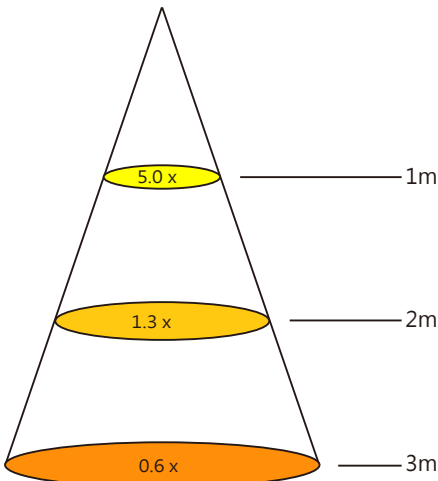
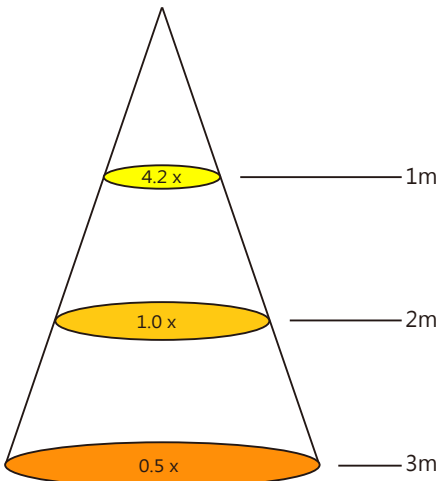
LL01ED-AJ25L	LL01ED-AJ40L
1. Beam Pattern	1. Beam Pattern
	
2. Light Distribution Curve	2. Light Distribution Curve
	
3. Illuminance	3. Illuminance
	

Notes: The Flux of CREE MC-E LED is 303 lm

Illumination charts

*CREE single white LED: CREE MC-E

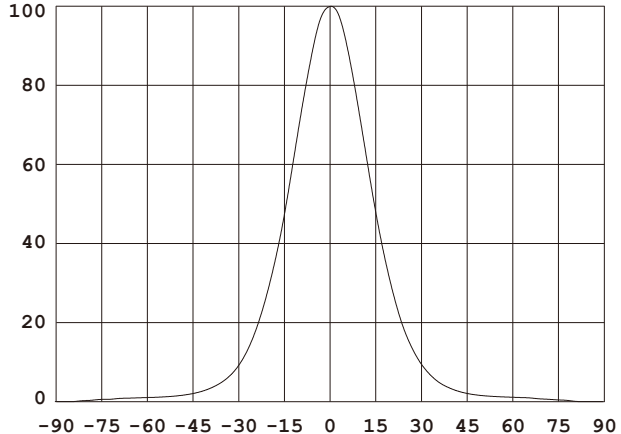
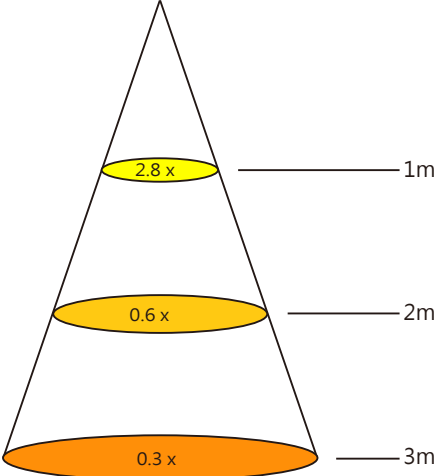
LL01ED-AJ60L	
1. Beam Pattern	
	
2. Light Distribution Curve	
	
3. Illuminance	
	

Notes: The Flux of CREE MC-E LED is 303 lm

Package

Item	Quantity	Total	Size (long*width* high)
Tray	72	72pcs	34*30*3.5 cm
Inner box	10tray/box	720pcs	35*31*21 cm
Outer box	2 Inner box/outer box	1440pcs	64.7*36.5*24 cm

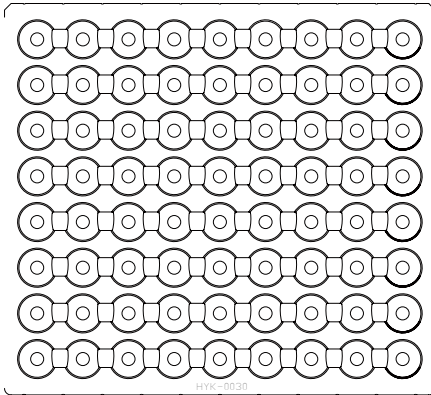

72pcs/tray

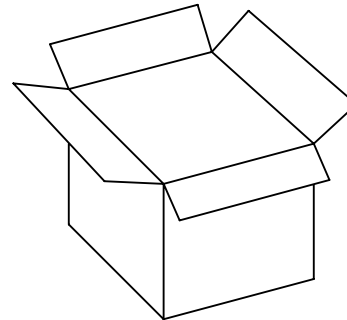
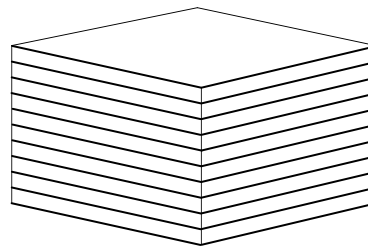

720pcs/inner box

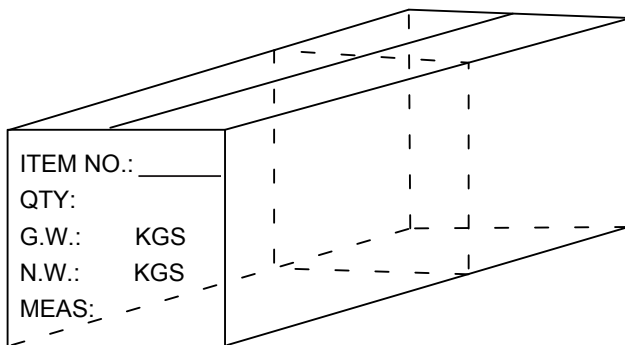

1440pcs/outer box

Product Nomenclature

