

DETAILS

Product Number	C11553_BARBARA-W
Family	Barbara
Type	Reflector
Color	metal
Diameter	70 mm
Height	44,7 mm
Style	round
Optic Material	PC
Holder Material	
Fastening	glue
Status	production ready
ROHS Compliant	Yes
Date Updated	17/05/2016

OPTICAL PROPERTIES

LED	Viewing	Light	Effi-		Connector
	Angle	Beam	ciency	cd/lm	
BXRA ES Rectangle	37 deg	Wide	90 %	2.010	-
CL-L330	35 deg	Wide	90 %	2.500	-
CLL03x/CLU03x	42 deg	Wide	89 %	1.800	-
CLU720/721	35 deg	Wide	91 %	2.000	-
CLU730/731	sim: 37	Wide	sim: 91 %	sim: 1.960	-
CXA2011	40 deg	Wide	90 %	1.560	-
COB 10W/13W/17W/24W	37 deg	Wide	89 %	2.000	-
CXM-14	41 deg	Wide	90 %	1.700	-
NSBxL110	31 deg	Wide	90 %	sim: 2.100	-
STARK SLE PURE G3 LES17	43 deg	Wide	91 %	1.610	-
SLE G5 LES15	40 deg	Wide	90 %	1.780	-



Relative intensity of C11553_BARBARA-W (COB-10W)

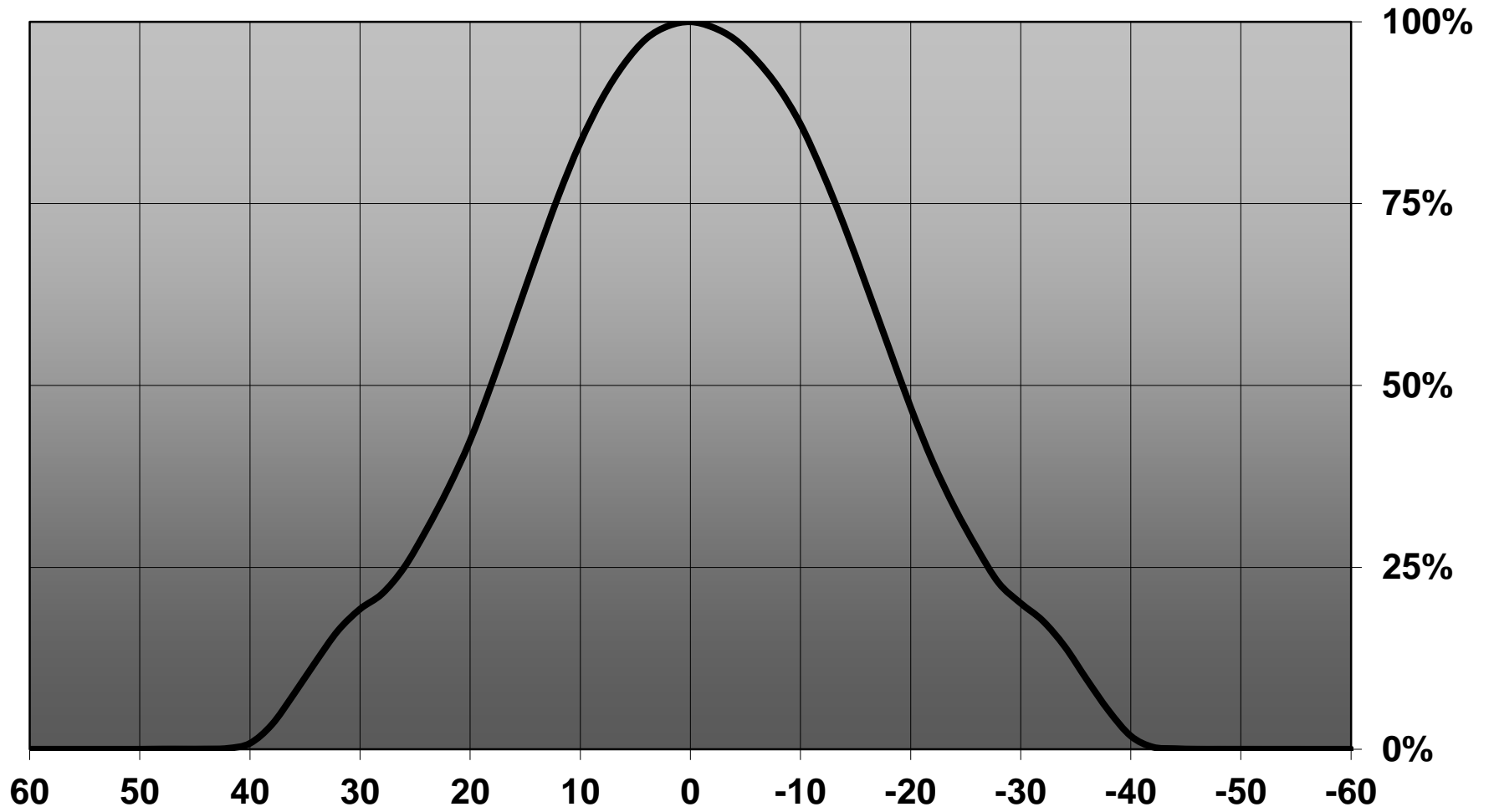

D

C

B

A

4

4

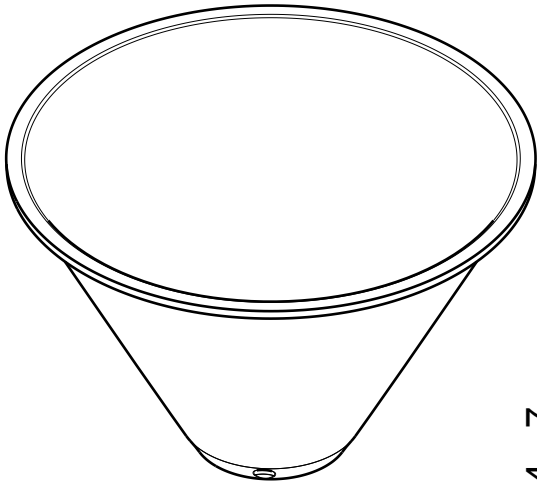

Isometric view

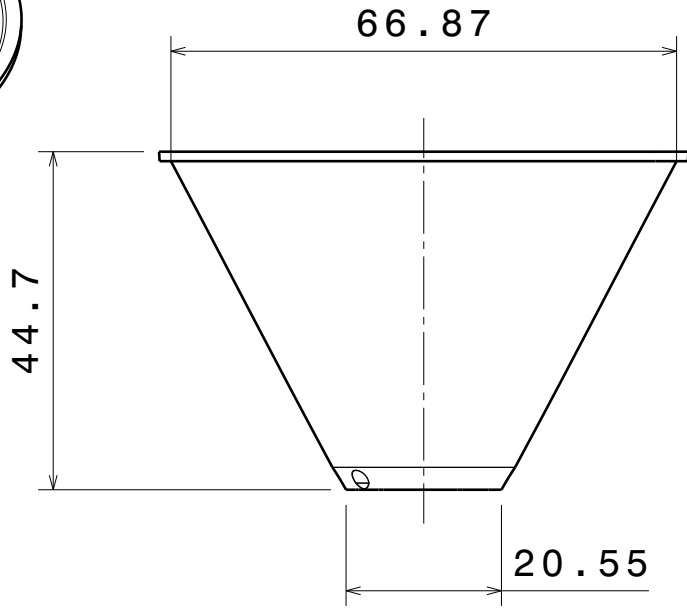

Front view

3

3

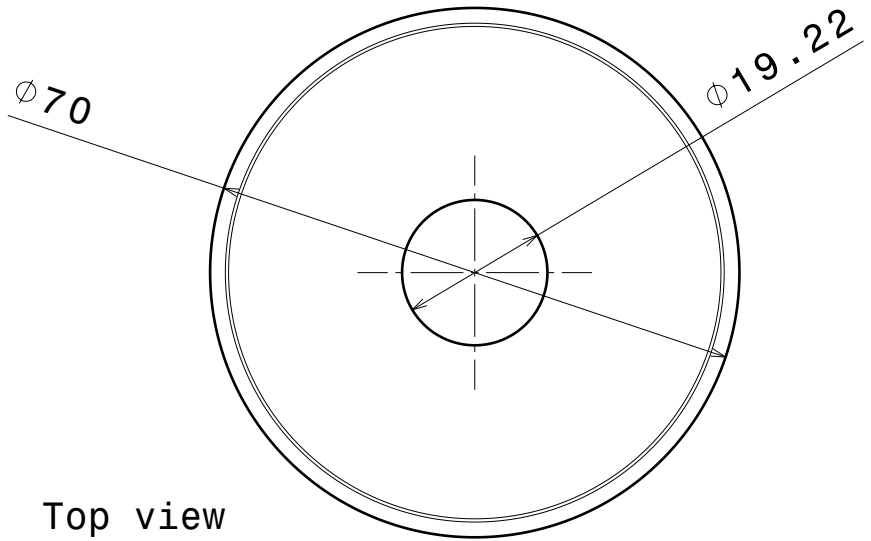

Top view

2

2

INDEX	DESCRIPTION	MATERIAL	COLOUR
1	Barbara reflector	PC	metal

Tolerances if not otherwise shown
 According to DIN ISO 2768-1
 Linear measures:
 up to 30mm class M, otherwise class C
 According to DIN ISO 2768-2
 Form and position: class L



Ledil Oy
 Salorankatu 10
 FIN 24240 SALO
 Finland

THIRD ANGLE PROJECTION:

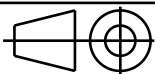

DRAWING TITLE

Barbara series datasheet

This drawing is the property
 of LEDiL Oy. It may not be
 reproduced, copied or
 communicated without a written
 agreement with LEDiL Oy.

SIZE	PART NUMBER
A4	-

SCALE	1:1	WEIGHT	-	SHEET	1/1
-------	-----	--------	---	-------	-----

1

1

D

A

Luminaire: Ledil Oy C11553_Barbara-W C11553_Barbara-W
Lamps: 1 x Bridgelux BXRA-C2002 (Wh)

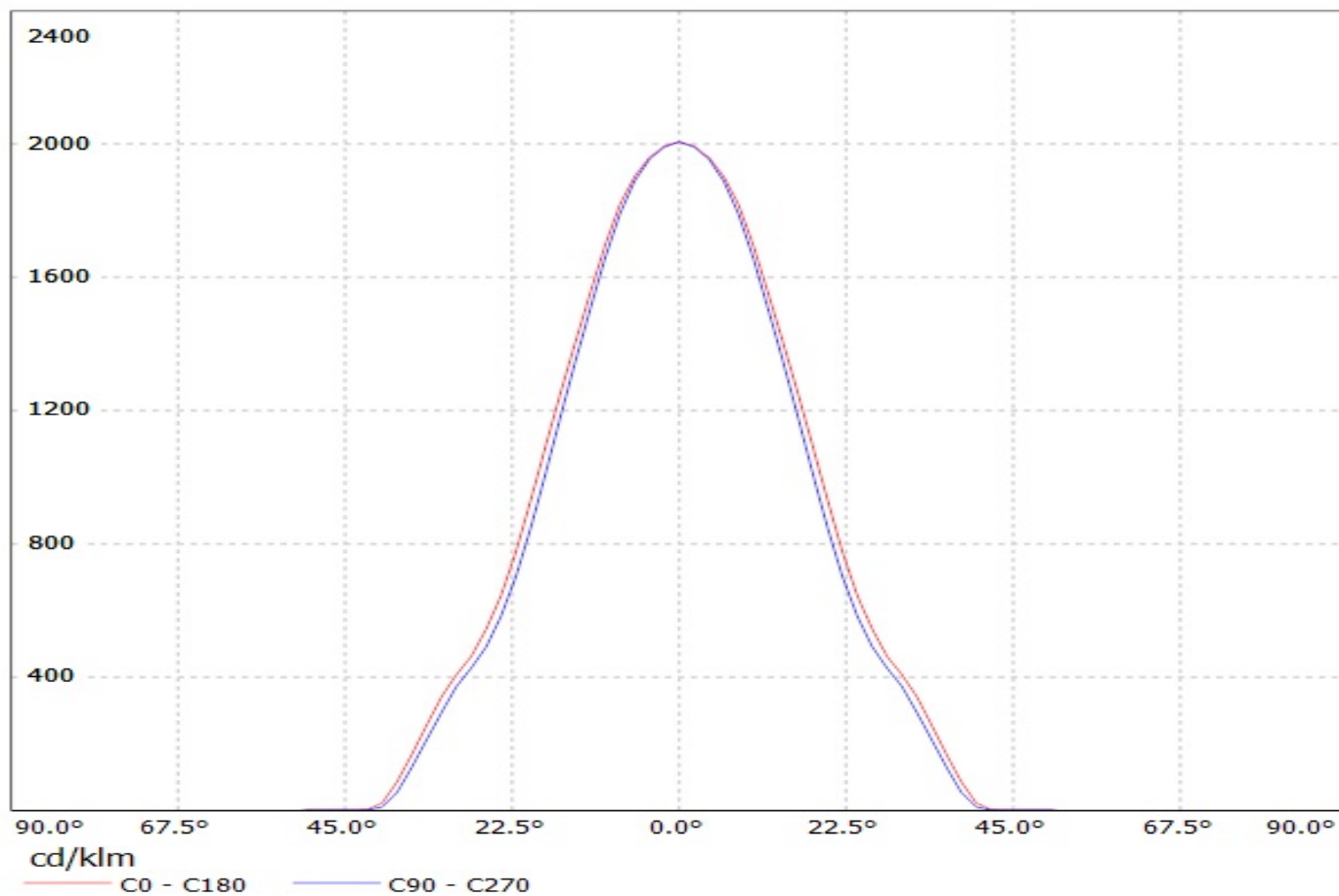

Luminaire: Ledil Oy C11553 BARBARA-W (Citizen CLL030 776lm @ 250mA) Efficiency=89%
Lamps: 1 x Citizen CLL030 776lm @ 250mA

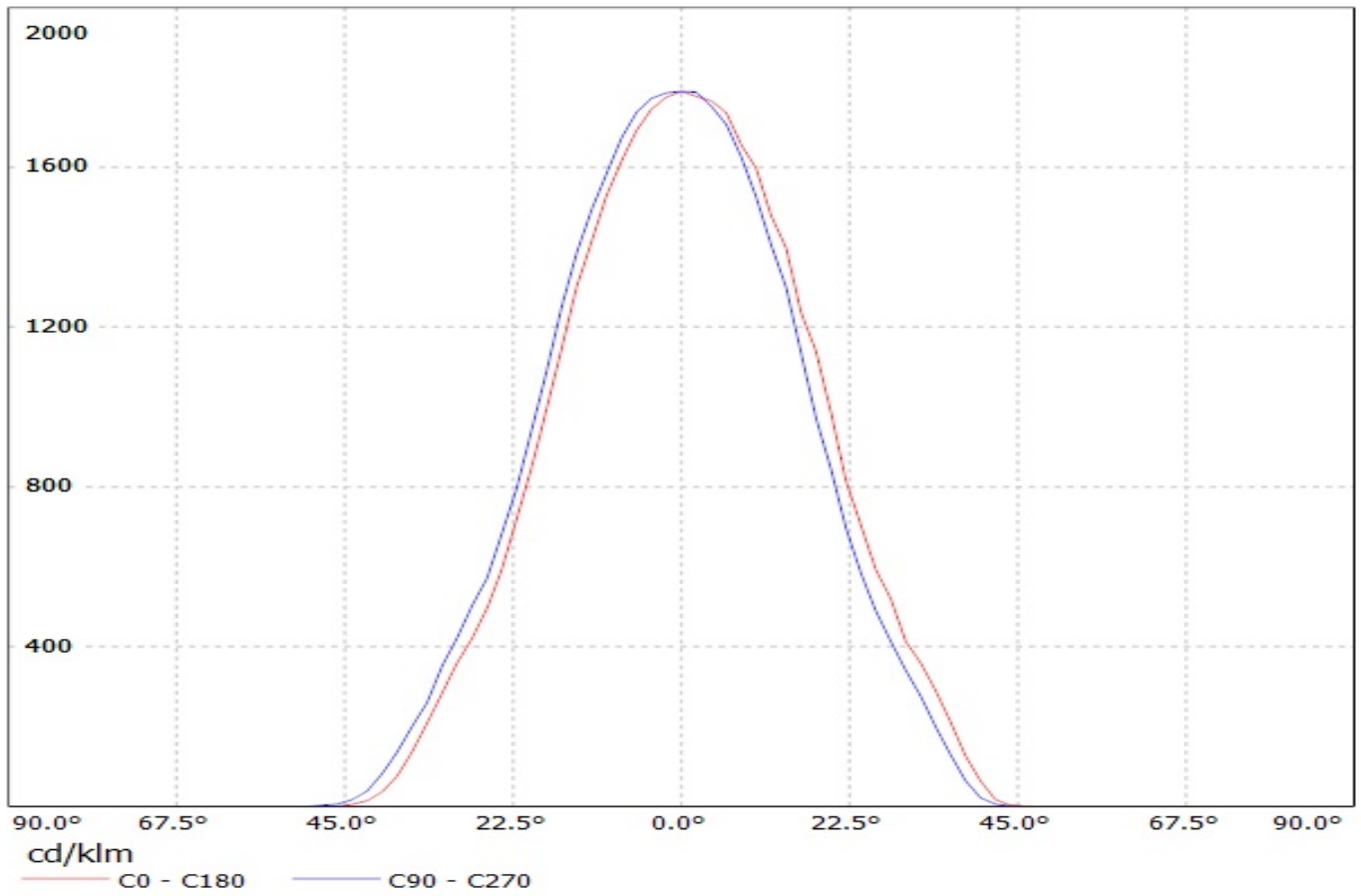

Luminaire: Ledil C11553_BARBARA-W_(CLU720)
Lamps: 1 x CITIZEN_CLU720_(CLU720-1206B8-273M2)
_1298.17lm@250mA_CCT=2700K_P=8.3W_I=0.25A

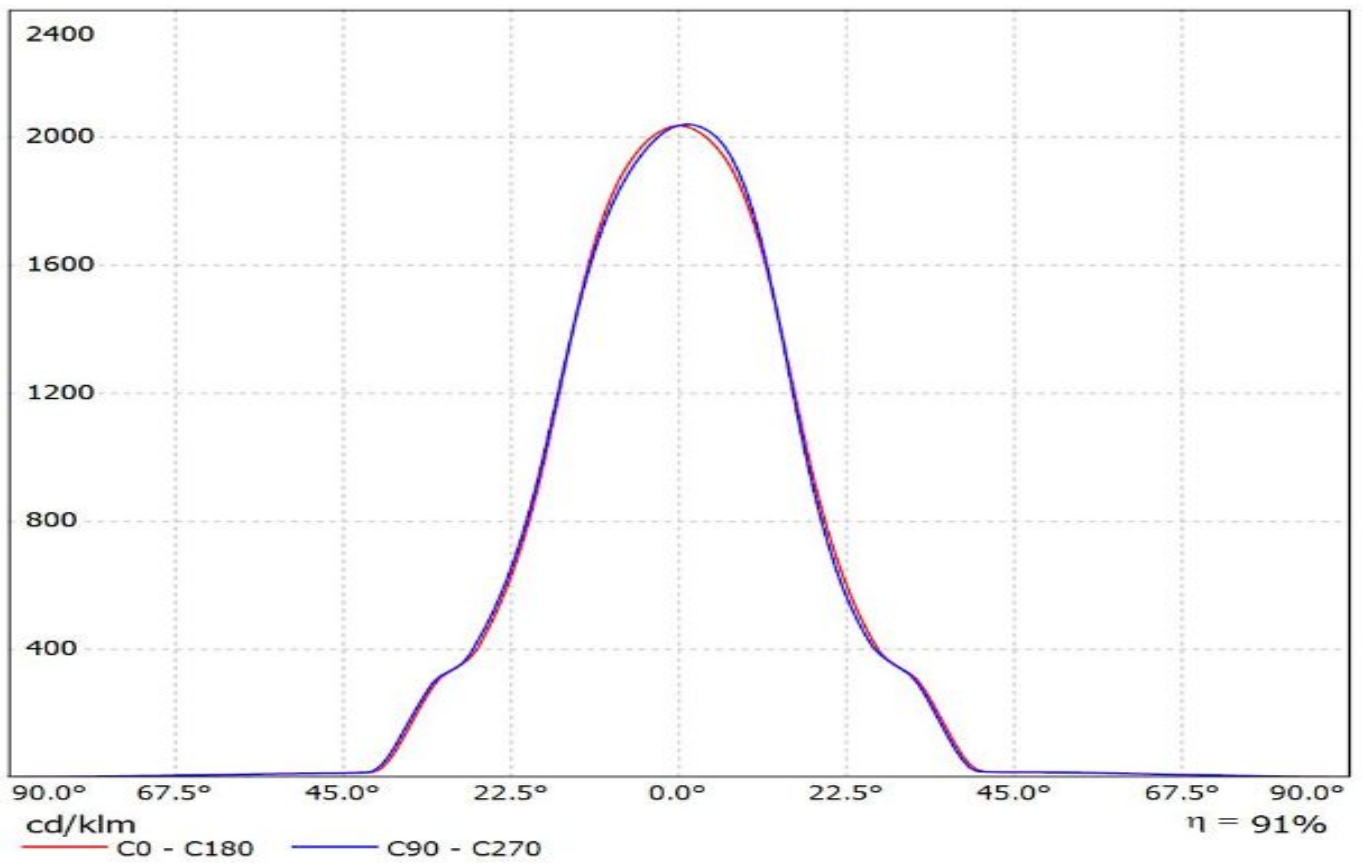

Luminaire: Ledil Oy C11553_Barbara-W_CXA20 C11553_Barbara-W_CXA20
Lamps: 1 x Cree CXA20

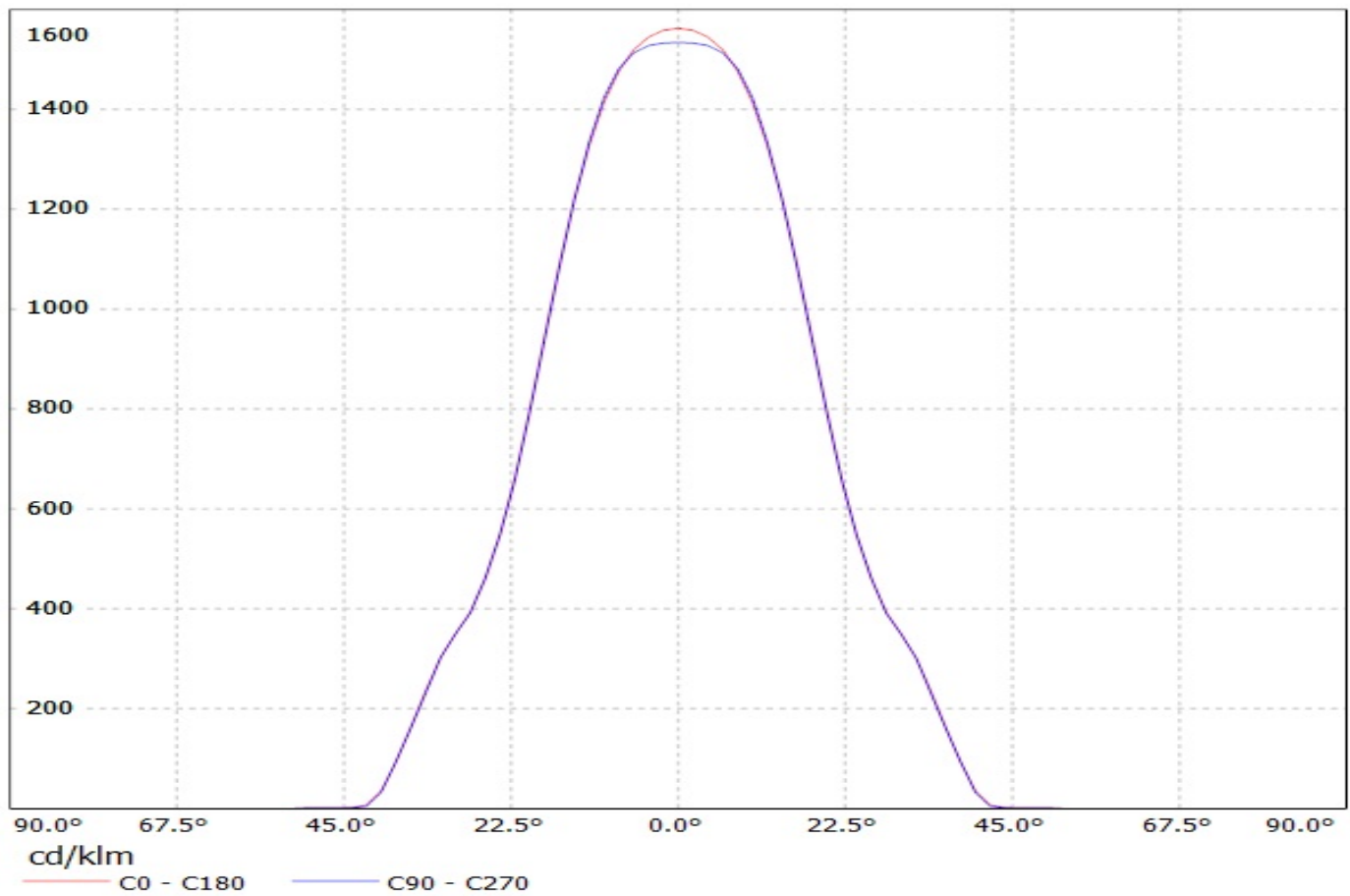

Luminaire: LEDil Oy C11553 BARBARA-W_(CXM-14)

Lamps: 1 x Luminus CXM-14 (1058.75lm @ 250mA) CCT=3100K P=8.3W I=250mA

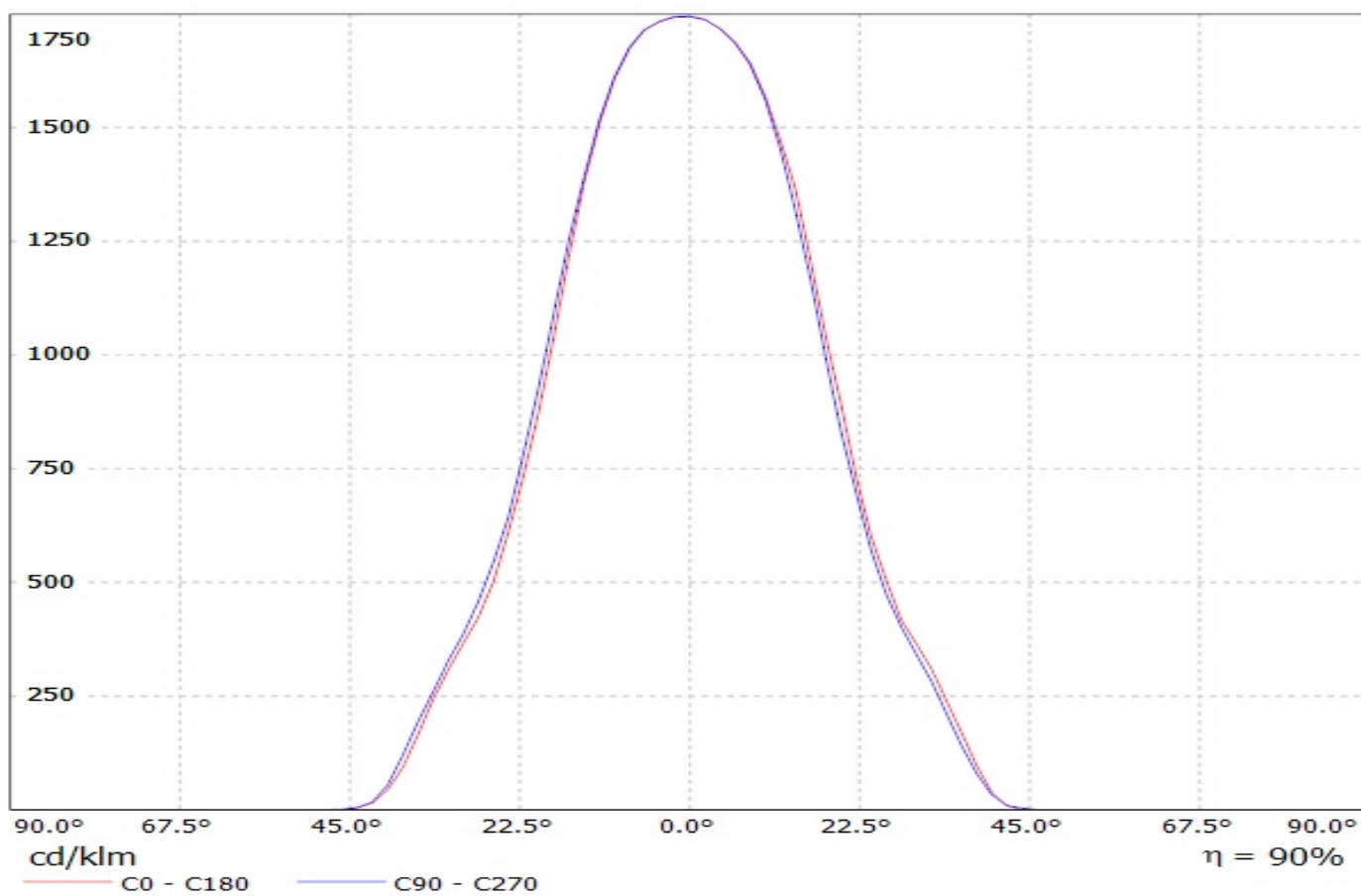

Luminaire: Ledil Oy C11553_BARBARA-W_(NSBxL110)_SIMULATED
Lamps: 1 x Nichia NSBxL110 (NSBLL110)

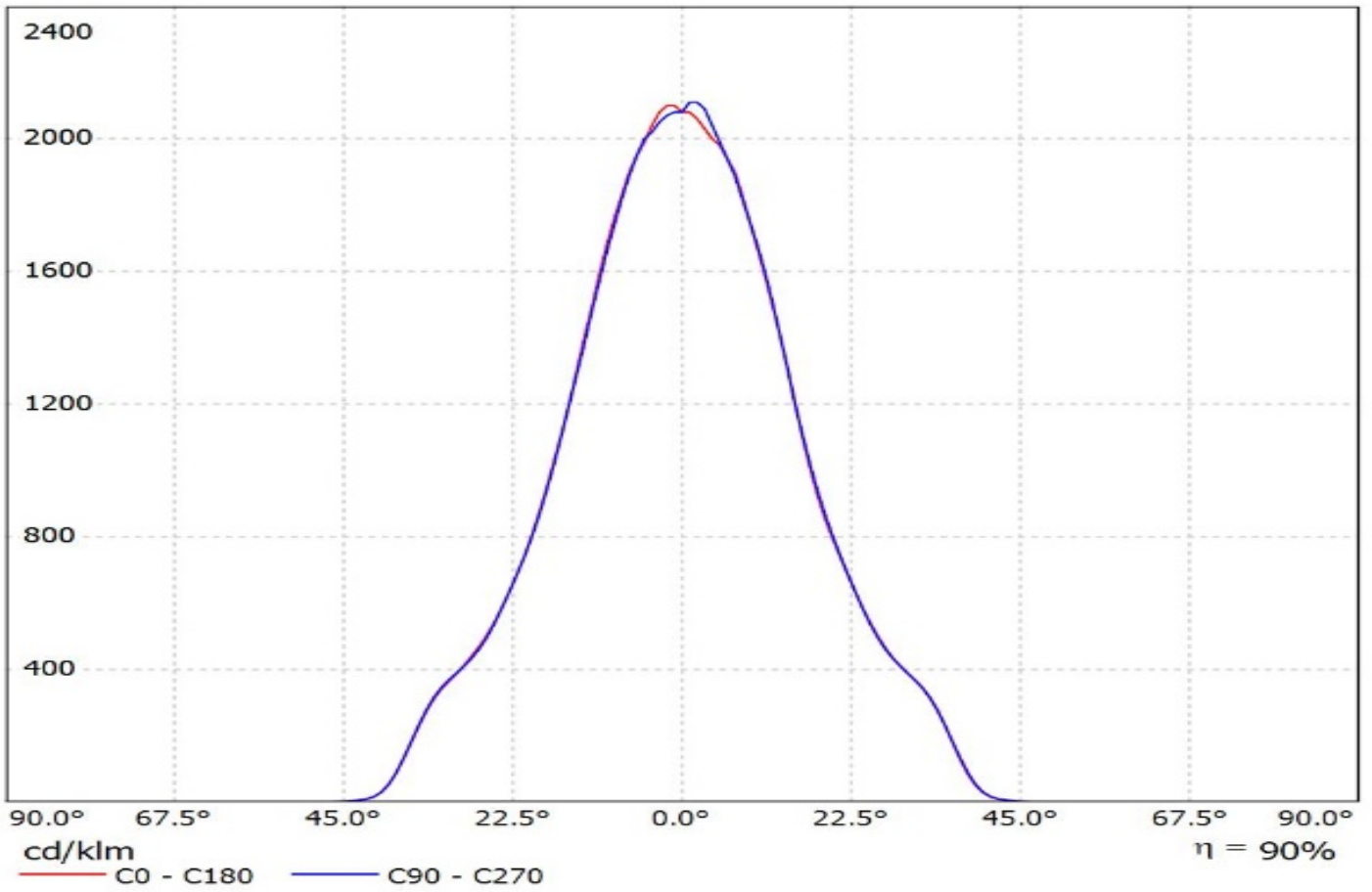

Luminaire: LEDiL Oy C11553_BARBARA-W_(SLE_G3_LES17) Eff.90.9%

Lamps: 1 x TRIDONIC_STARK_SLE_G3_LES17_(STARK-SLE-PURE_G3-17-2000-840-CLA)_1011.62lm@250mA_P=8.29243W_I=249.9mA

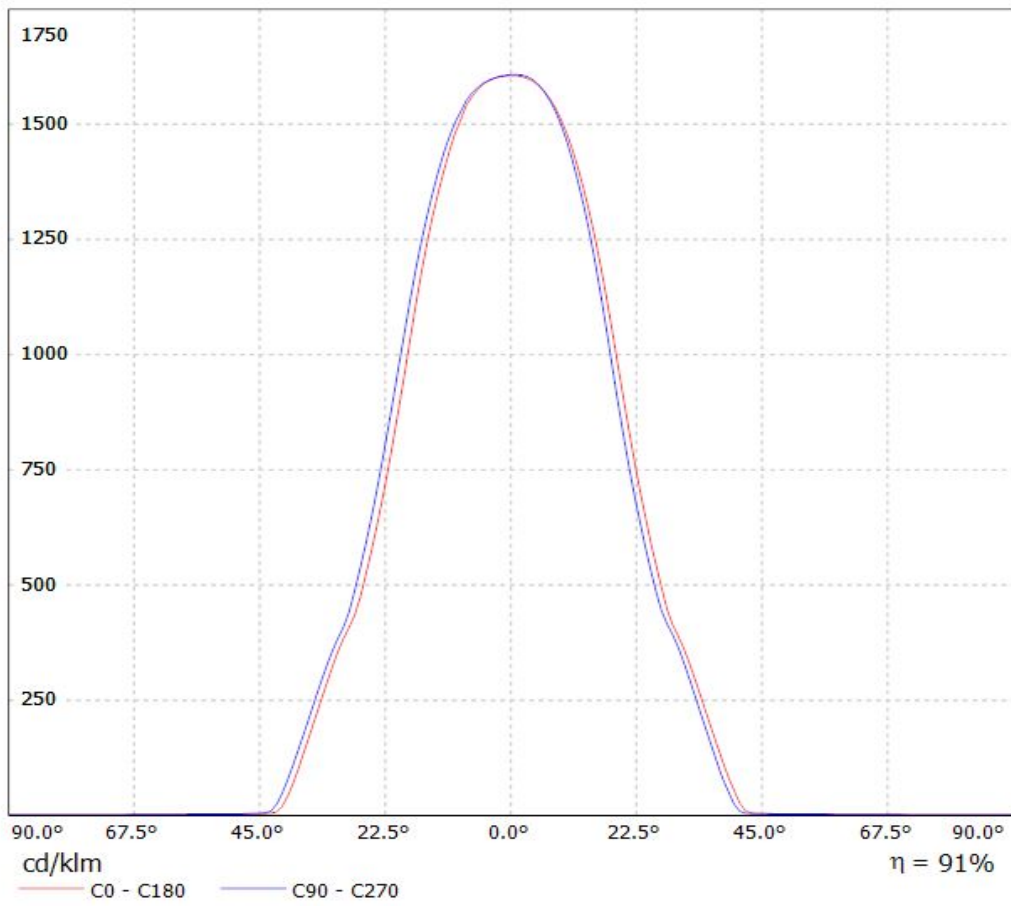

Luminaire: LEDiL Oy C11553_BARBARA-W_(SLE-G5_LES-15)
Lamps: 1 x Tridonic_SLE-G5_LES-15_1280.24lm@250mA_P=8.6273W_I=0.250A

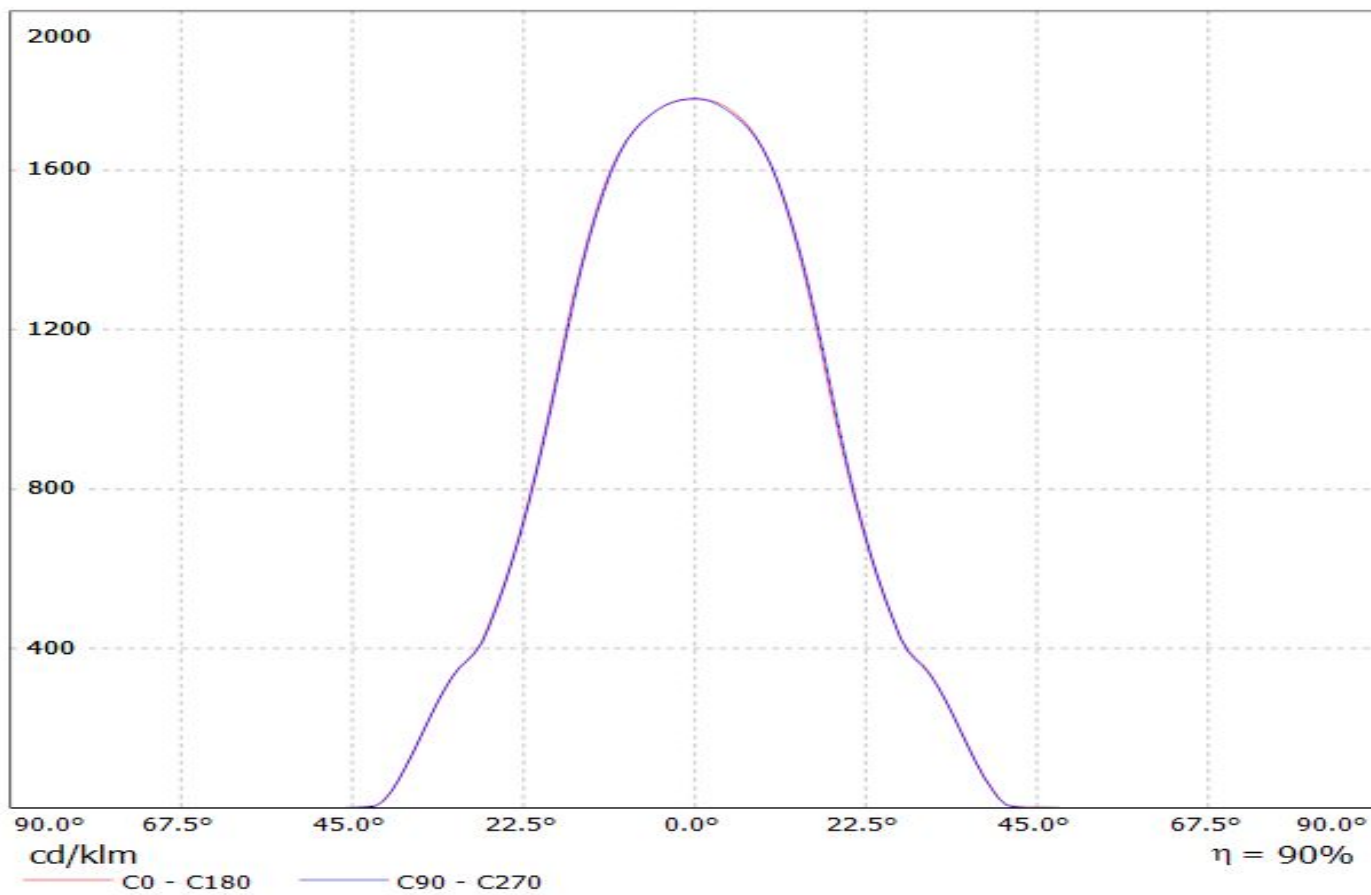

Luminaire: Ledil Oy C11553_Barbara-W C11553_Barbara-W
Lamps: 1 x Bridgelux BXRA-C2002 (Wh

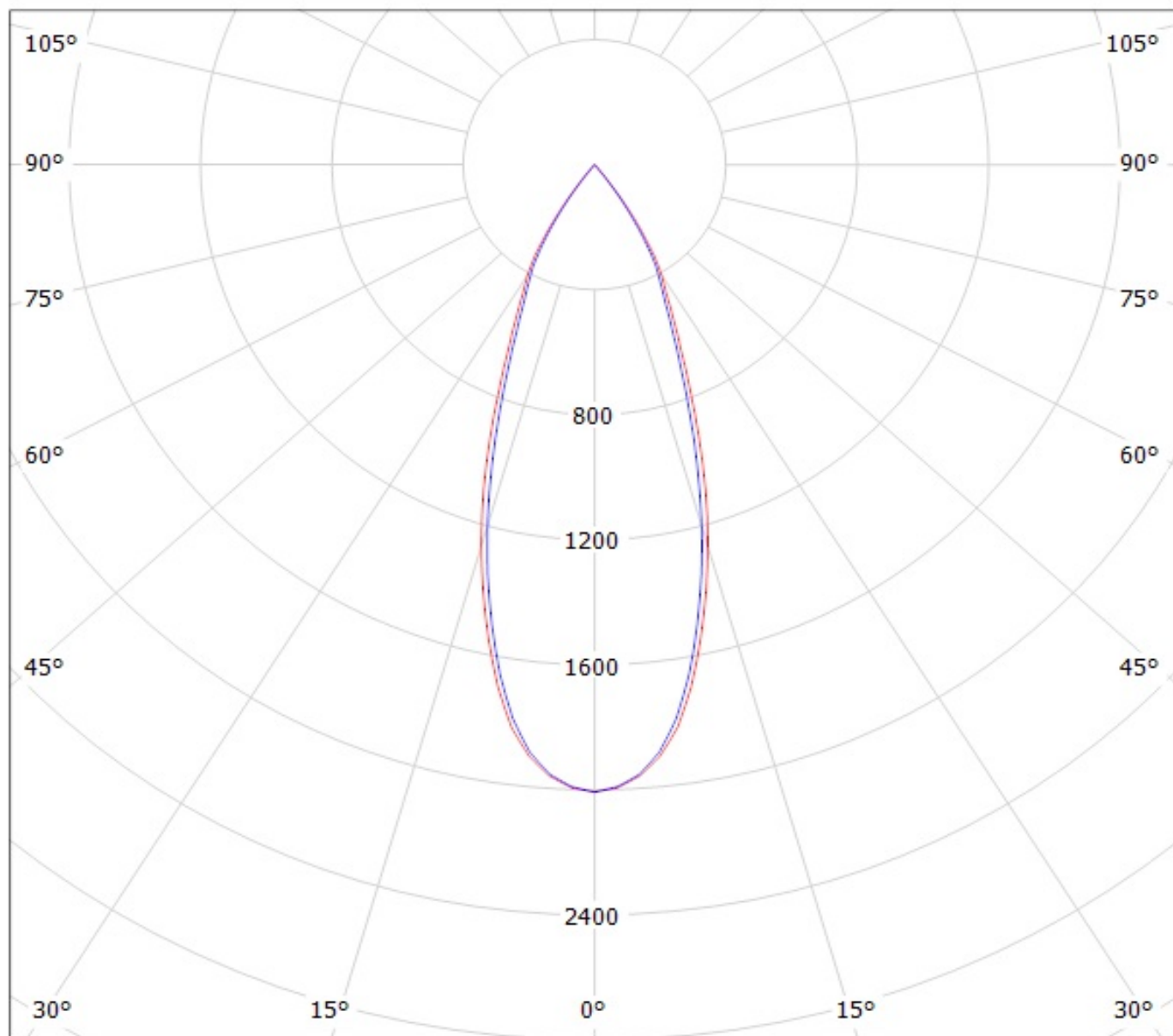

cd/klm

— C0 - C180 — C90 - C270

Luminaire: Ledil Oy C11553 BARBARA-W (Citizen CLL030 776lm @ 250mA) Efficiency=89%
Lamps: 1 x Citizen CLL030 776lm @ 250mA

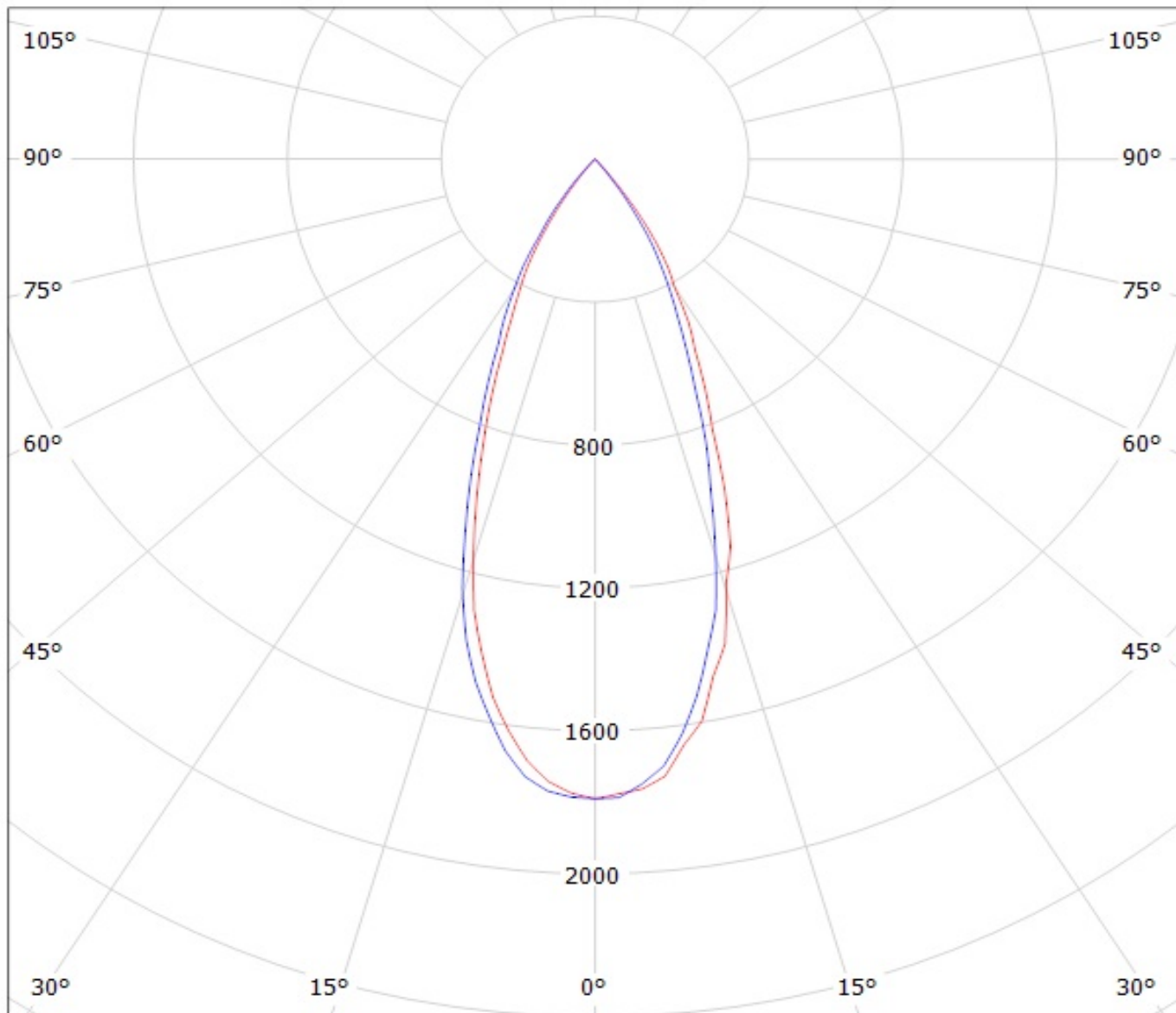

cd/klm

— C0 - C180

— C90 - C270

Luminaire: Ledil C11553_BARBARA-W_(CLU720)
Lamps: 1 x CITIZEN_CLU720_(CLU720-1206B8-273M2)
_1298.17lm@250mA_CCT=2700K_P=8.3W_I=0.25A

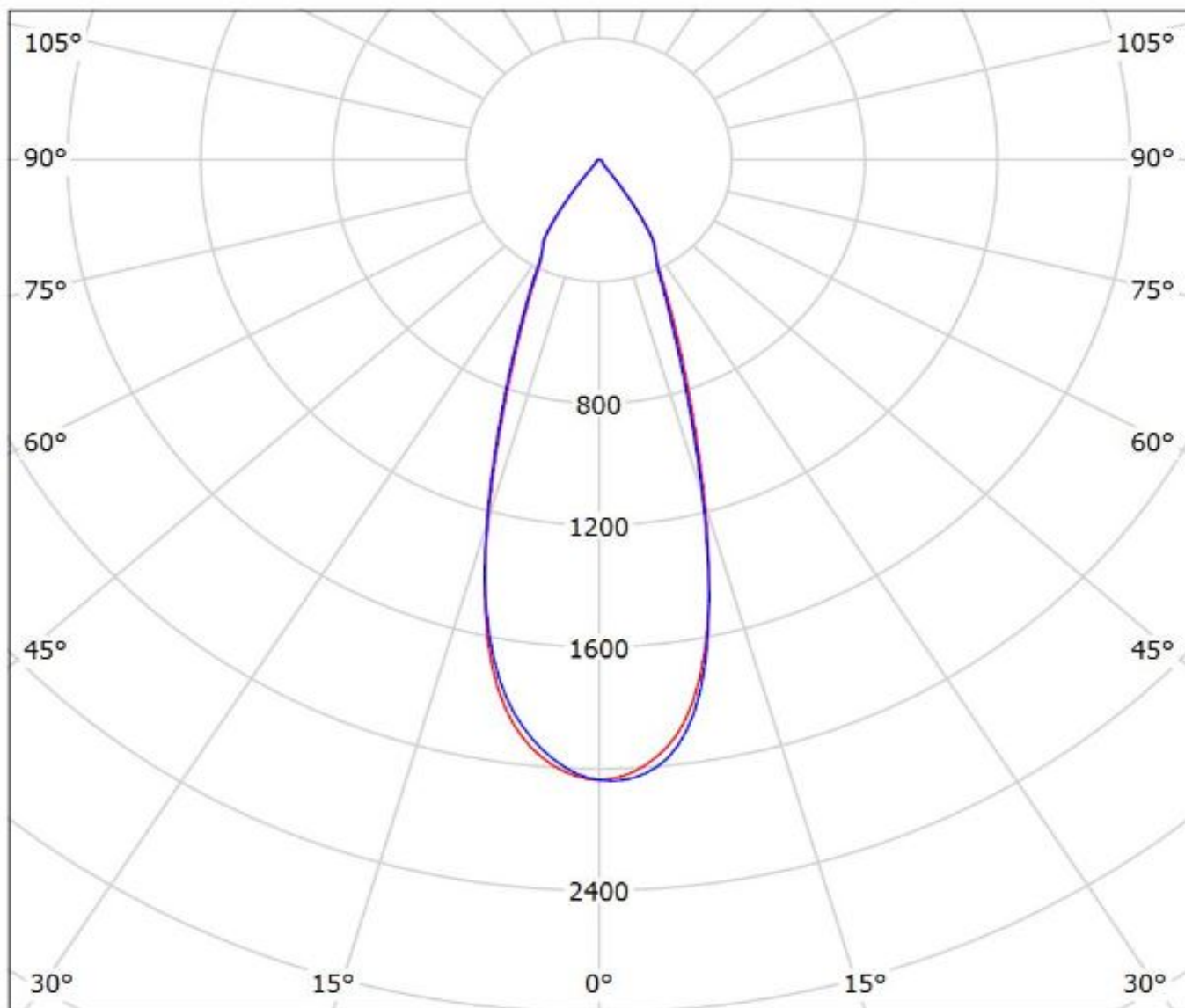

cd/klm

— C0 - C180 — C90 - C270

$\eta = 91\%$

Luminaire: Ledil Oy C11553_Barbara-W_CXA20 C11553_Barbara-W_CXA20
Lamps: 1 x Cree CXA20

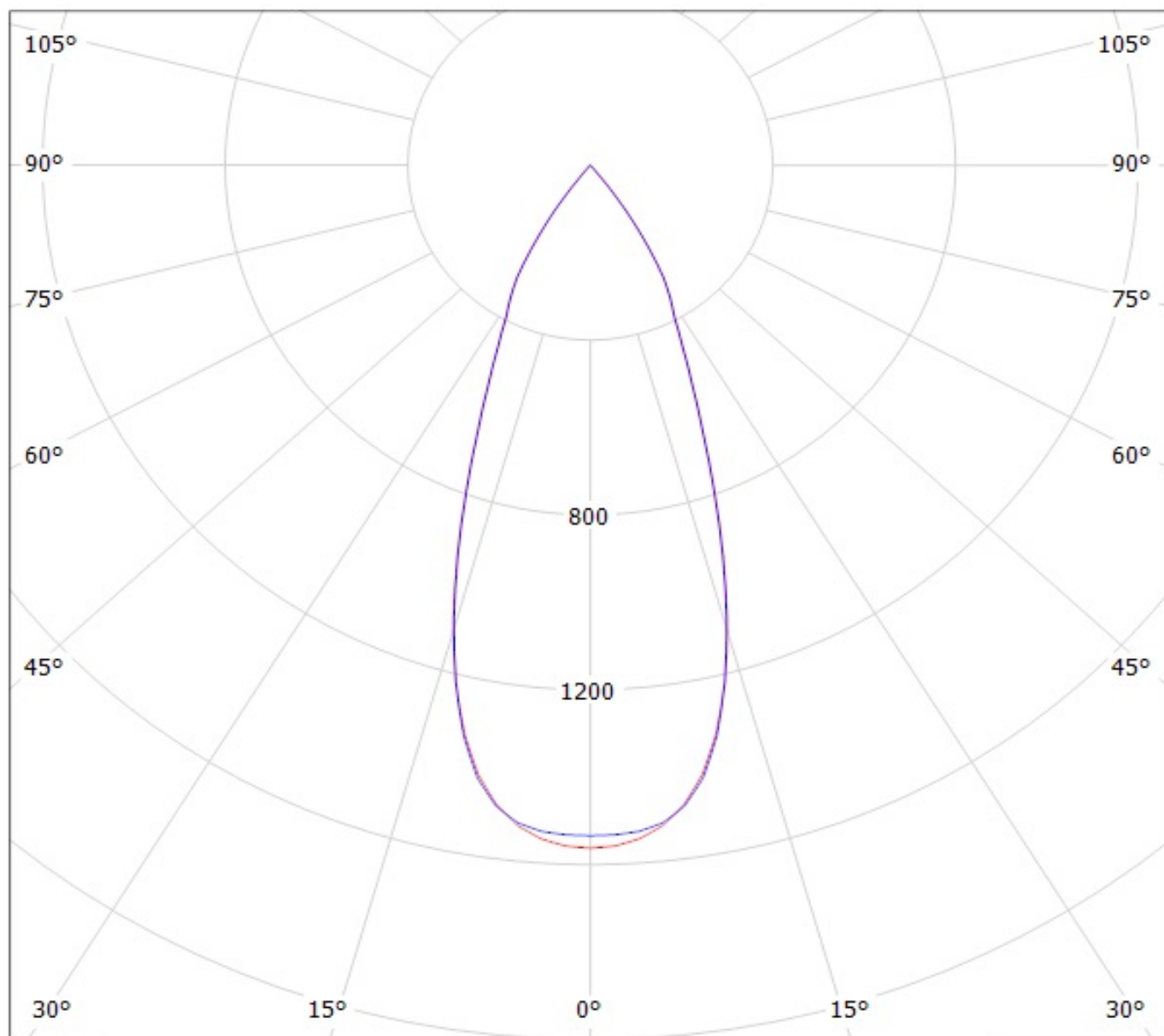

cd/klm

— C0 - C180

— C90 - C270

Luminaire: LEDil Oy C11553_BARBARA-W_(CXM-14)

Lamps: 1 x Luminus CXM-14 (1058.75lm @ 250mA) CCT=3100K P=8.3W I=250mA

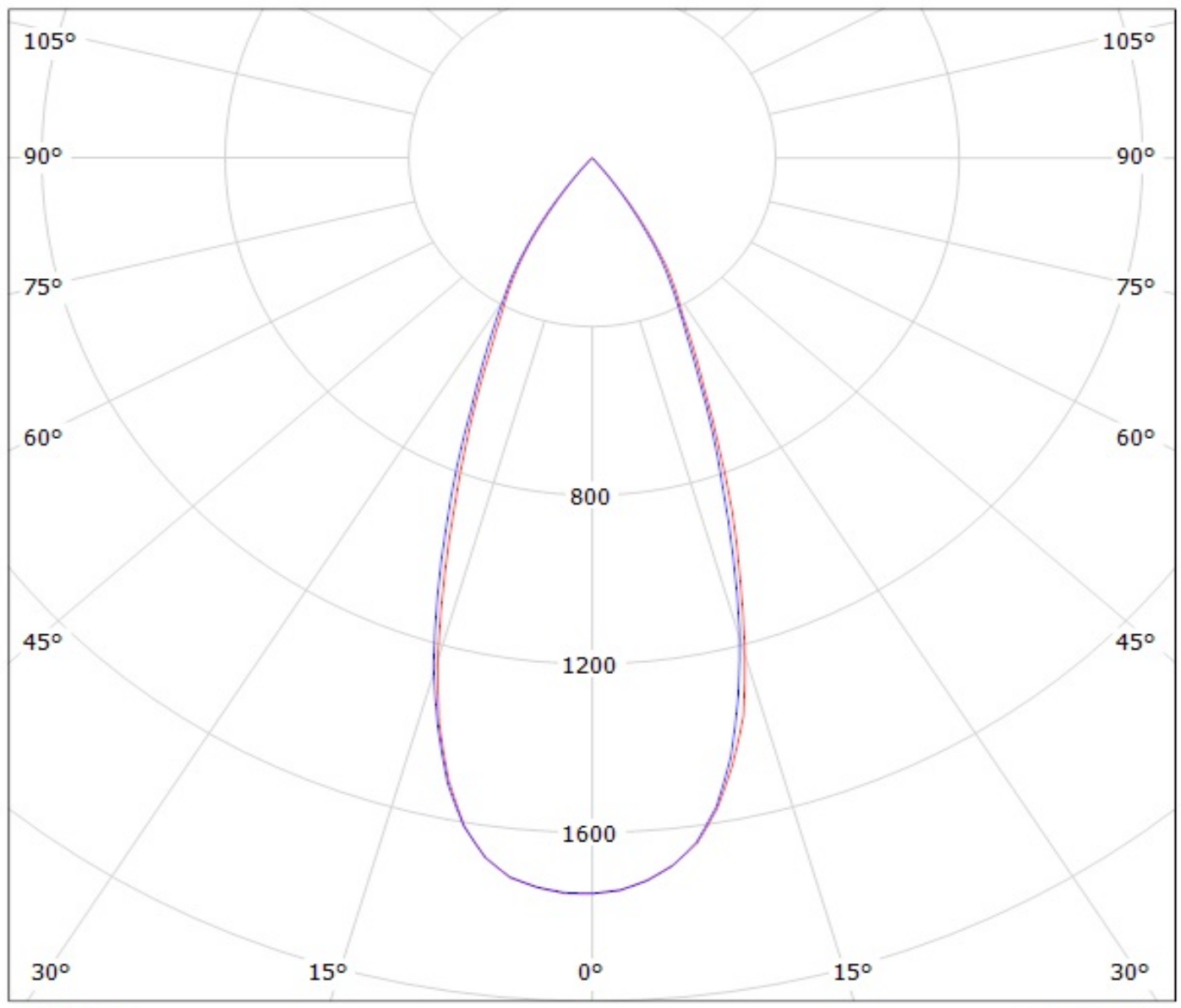

cd/klm

— C0 - C180

— C90 - C270

$\eta = 90\%$

Luminaire: Ledil Oy C11553_BARBARA-W_(NSBxL110)_SIMULATED
Lamps: 1 x Nichia NSBxL110 (NSBLL110)

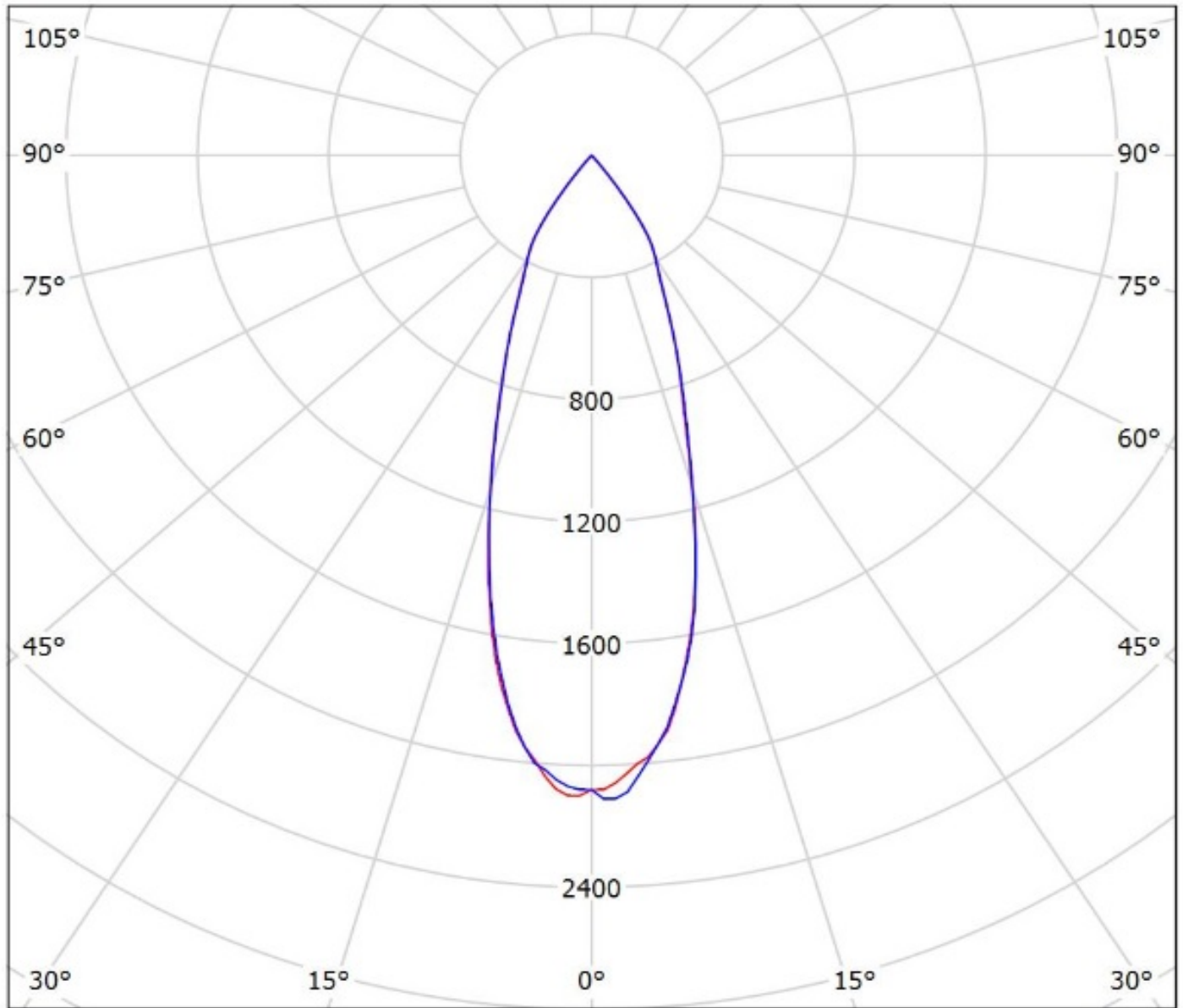

cd/klm
— C0 - C180 — C90 - C270

$\eta = 90\%$

Luminaire: LEDiL Oy C11553_BARBARA-W_(SLE_G3_LES17) Eff.90.9%

Lamps: 1 x TRIDONIC_STARK_SLE_G3_LES17_(STARK-SLE-PURE_G3-17-2000-840-CLA)_1011.62lm@250mA_P=8.29243W_I=249.9mA

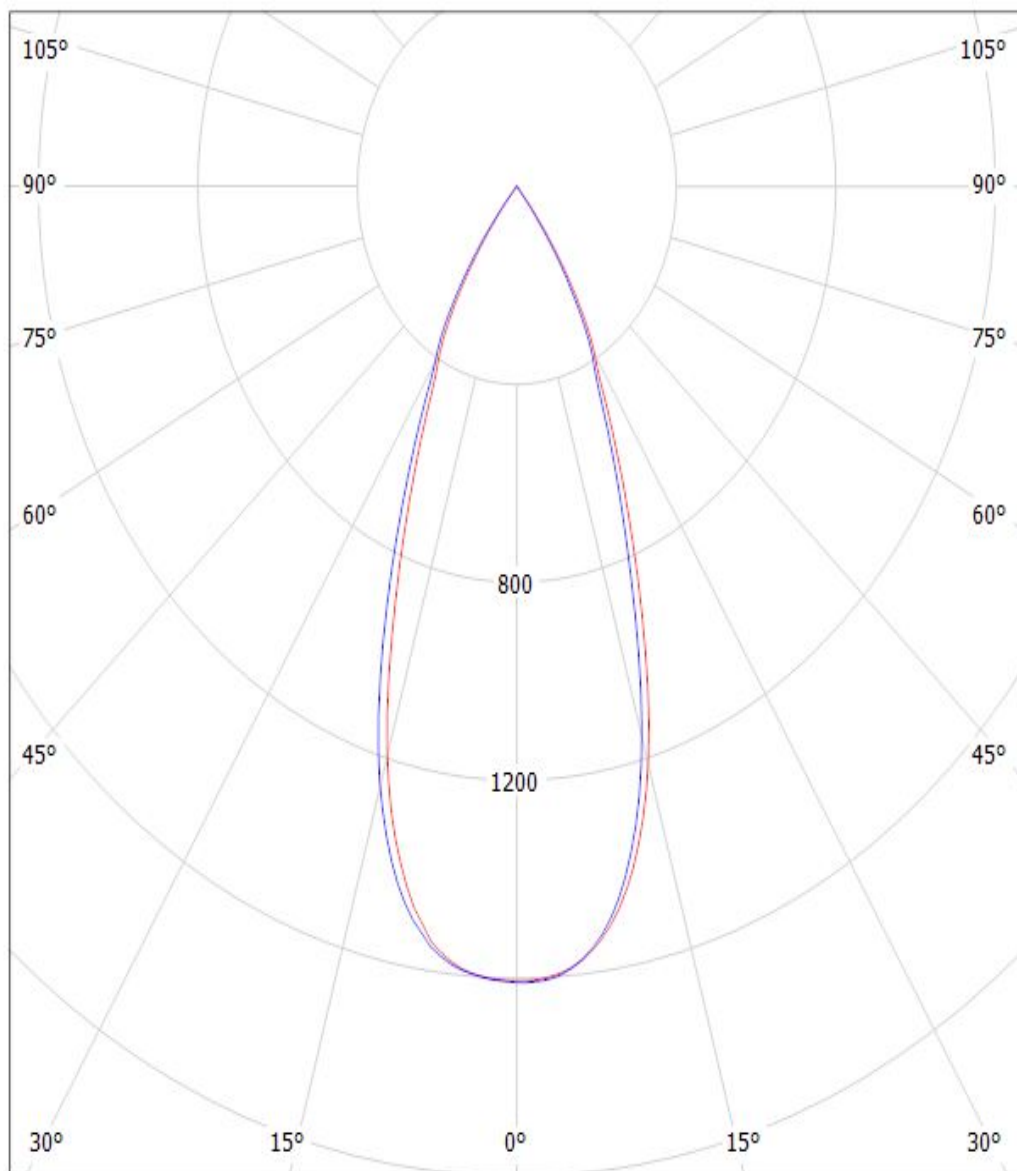

cd/klm

η = 91%

— C0 - C180

— C90 - C270

Luminaire: LEDiL Oy C11553_BARBARA-W_(SLE-G5_LES-15)
Lamps: 1 x Tridonic_SLE-G5_LES-15_1280.24lm@250mA_P=8.6273W_I=0.250A

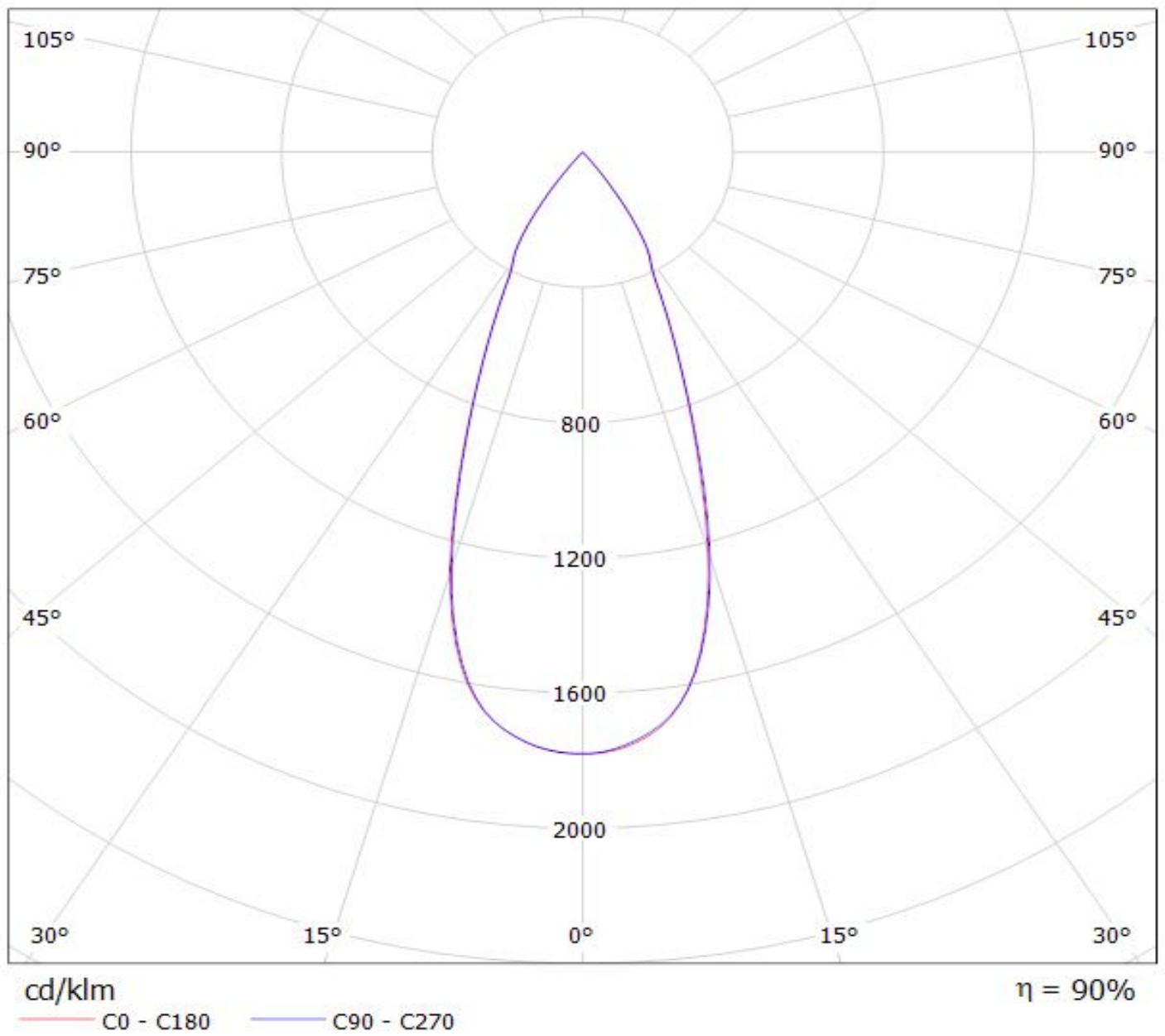

NOTE: The typical divergence will be changed by different color, chip size and chip position tolerance. The typical total divergence is the full angle measured where the luminous intensity is half of the peak value.

GENERAL INFORMATION

- Product series especially designed & optimized for series of LEDs.
- Special care taken to make light distribution as uniform as possible.

Note! Due to use of high power COB's with this product, special attention to proper thermal design is highly recommended. LEDiL has no liability for direct, indirect or consecutive damages arising from the LEDiL products being used outside of the recommended temperature range.