

# Connector

## Ejector Header 2.54mm(0.100")

### Electrical Characteristics:

Current Rating: 1 AMP  
 Insulator Resistance: 5000MΩmin. at DC 500V  
 Contact Resistance: 20mΩmax. at DC 100mA  
 Operating Temperature: -45°C~+105°C

### Material:

Housing: 30% Glass filled PBT UL94V-0  
 Contacts: Brass  
 Plating: Gold plated: 2u". over 50u" nickel

### Features:

- \* Fully shrouded provides ultimate reliability,
- \* Black or gray insulator available.
- \* Choices of Eject lever.

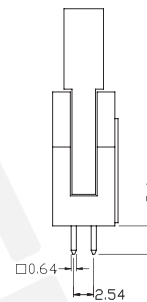
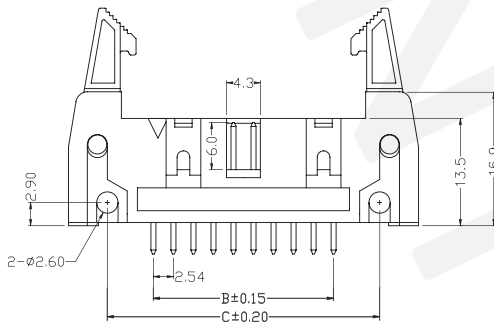

Straight Type

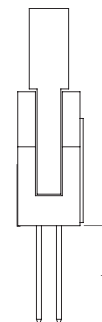

Long Dip

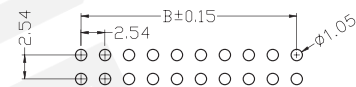
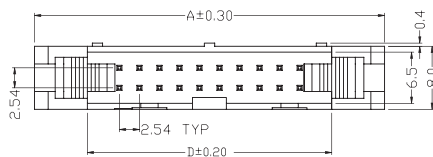

P. C. B Layout

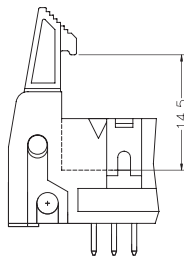

Long Lever

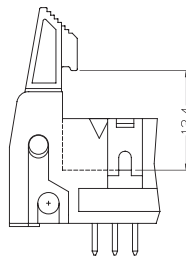

Short Lever

### Dimension

position	A	B	C	D
06	26.52	5.08	16.76	13.22
08	29.06	7.62	19.30	15.76
10	31.60	10.16	21.84	18.30
14	36.68	15.24	26.92	23.38
16	39.22	17.78	29.46	25.92
20	44.30	22.86	34.54	31.00
26	51.92	30.48	42.16	38.62
30	57.00	35.56	47.24	43.70
34	62.08	40.64	52.32	48.78
40	69.70	48.26	59.94	56.40
50	82.40	60.96	72.64	69.10
60	95.10	73.66	85.34	81.80
64	100.18	78.74	90.42	86.88