

## IRIS-M

~25° medium beam with sublens and holder

### TECHNICAL SPECIFICATIONS:

Dimensions	Ø 38.0 mm
Height	30 mm
Fastening	glue, screw
ROHS compliant	yes ⓘ

### MATERIAL SPECIFICATIONS:

Component	Type	Material	Colour	Finish
IRIS	Single lens	PMMA	clear	
IRIS-HLD	Holder	PC	black	
LEDILSTAR-SUB	Sublens	PC		



### ORDERING INFORMATION:

Component		Qty in box	MOQ	MPQ	Box weight (kg)
CN10953_IRIS-M	Single lens	348	116	116	0.0
» Box size:					

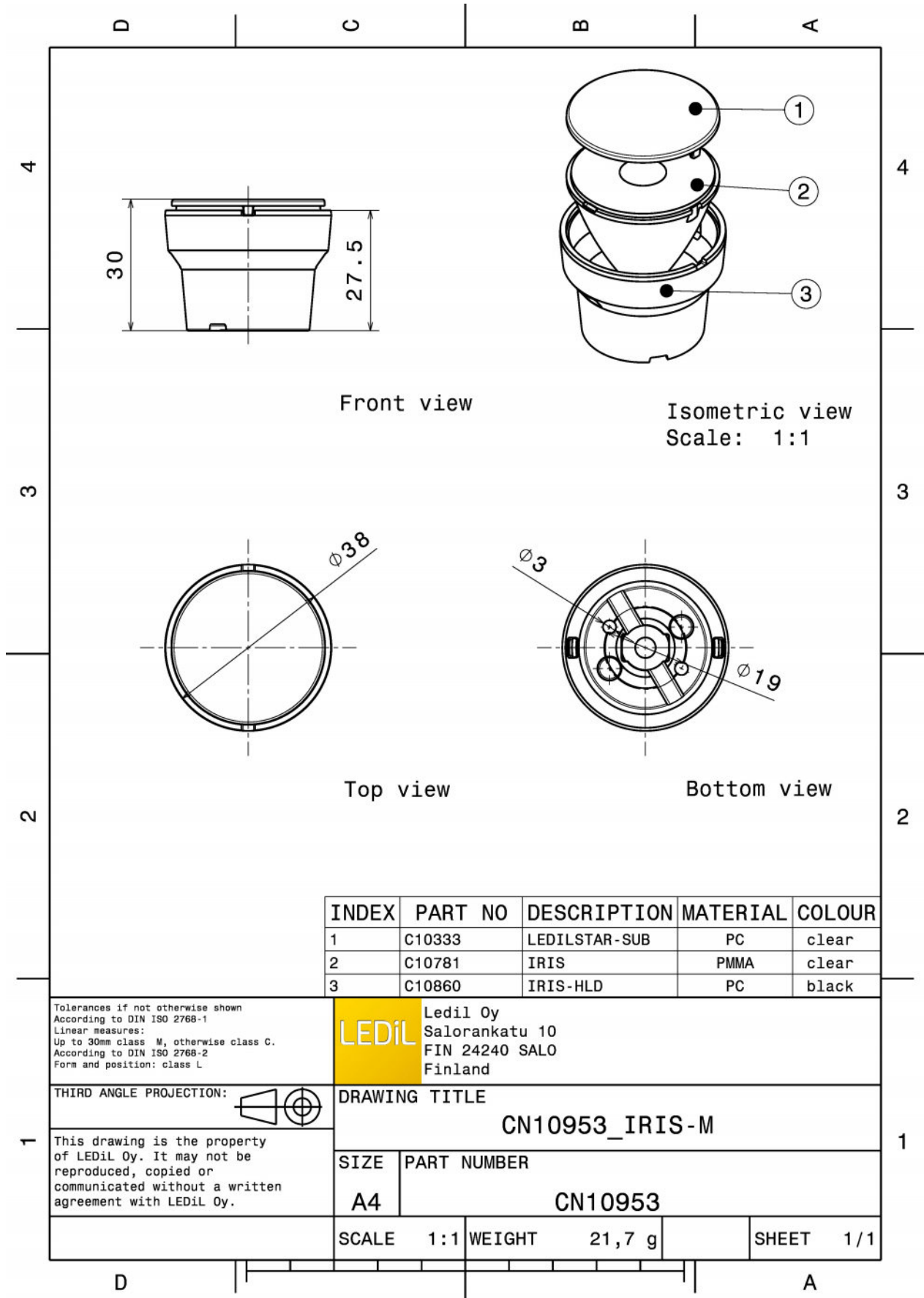

See also our general installation guide: [www.ledil.com/installation\\_guide](http://www.ledil.com/installation_guide)

### PHOTOMETRIC DATA (MEASURED):

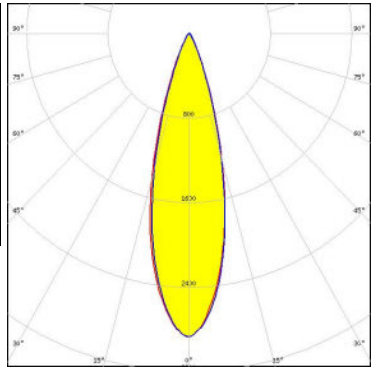
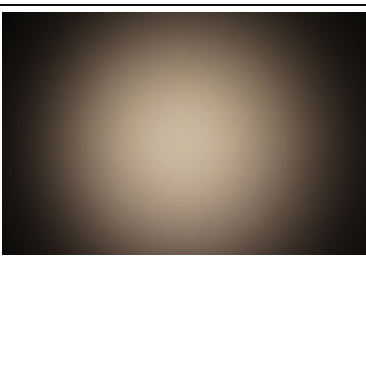
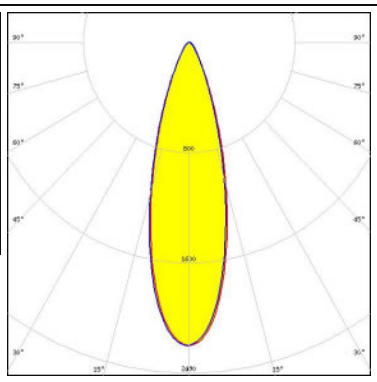
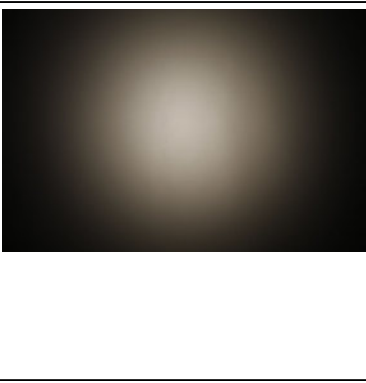
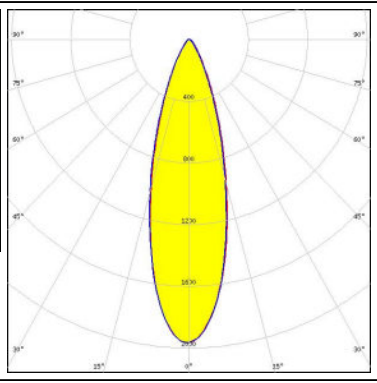
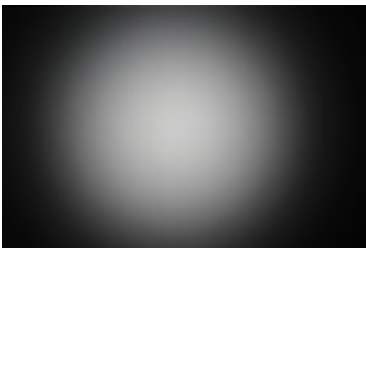
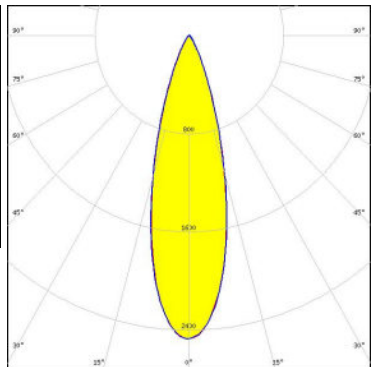
<p><b>CREE</b> → <b>LED</b></p> <p>LED MC-E            FWHM / FWTM 28.0° / 48.0°            Efficiency 81 %            Peak intensity 2.9 cd/lm            LEDs/each optic 1            Light colour White            Required components:</p>		
<p><b>CREE</b> → <b>LED</b></p> <p>LED MHD-E/G            FWHM / FWTM 30.0° / 58.0°            Efficiency 93 %            Peak intensity 2.2 cd/lm            LEDs/each optic 1            Light colour White            Required components:</p>		
<p><b>CREE</b> → <b>LED</b></p> <p>LED XHP50            FWHM / FWTM 30.0° / 60.0°            Efficiency 75 %            Peak intensity 2 cd/lm            LEDs/each optic 1            Light colour White            Required components:</p>		
<p><b>CREE</b> → <b>LED</b></p> <p>LED XHP50.2            FWHM / FWTM 29.0° / 53.0°            Efficiency 77 %            Peak intensity 2.5 cd/lm            LEDs/each optic 1            Light colour White            Required components:</p>		

### PHOTOMETRIC DATA (MEASURED):

**OSRAM**  
Opto Semiconductors

LED Duris S10  
FWHM / FWTM 30.0° / 56.0°  
Efficiency 75 %  
Peak intensity 2.4 cd/lm  
LEDs/each optic 1  
Light colour White  
Required components:

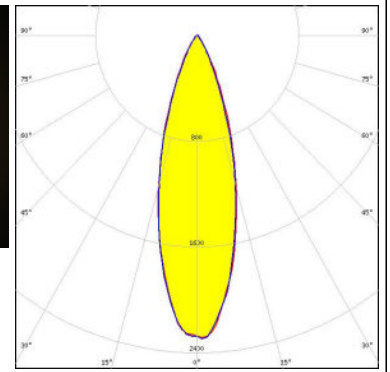

### PHOTOMETRIC DATA (SIMULATED):

#### CREE → LED

LED XD16  
 FWHM / FWTM 12.0° / 24.0°  
 Efficiency 76 %  
 Peak intensity 13.1 cd/lm  
 LEDs/each optic 1  
 Light colour White  
 Required components:

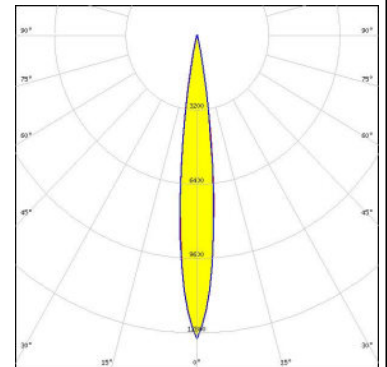

#### CREE → LED

LED XHP35 HD  
 FWHM / FWTM 14.0° / 28.0°  
 Efficiency 84 %  
 Peak intensity 10.4 cd/lm  
 LEDs/each optic 1  
 Light colour White  
 Required components:

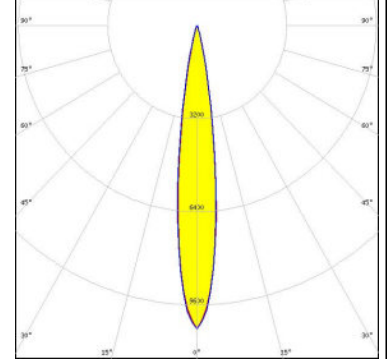

#### CREE → LED

LED XHP35 HI  
 FWHM / FWTM 13.0° / 24.0°  
 Efficiency 84 %  
 Peak intensity 13.5 cd/lm  
 LEDs/each optic 1  
 Light colour White  
 Required components:

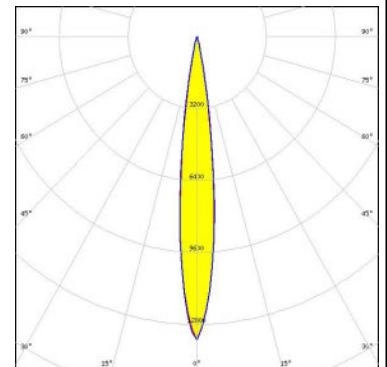

#### CREE → LED

LED XHP50.3 HD  
 FWHM / FWTM 15.0 + 16.0° / 28.0°  
 Efficiency 80 %  
 Peak intensity 9.5 cd/lm  
 LEDs/each optic 1  
 Light colour White  
 Required components:

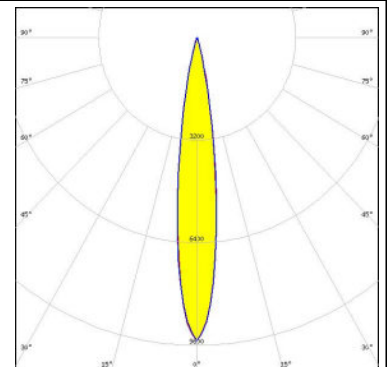

### PHOTOMETRIC DATA (SIMULATED):



LED XP-E2  
FWHM / FWTM 12.0° / 22.0°  
Efficiency 83 %  
Peak intensity 15.6 cd/lm  
LEDs/each optic 1  
Light colour White  
Required components:

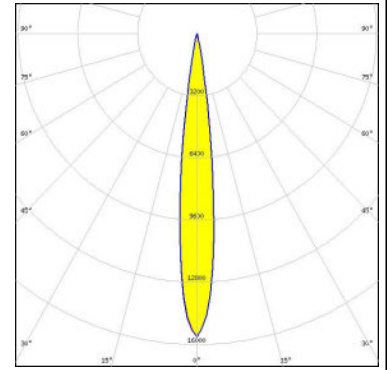

LED OSLOM Square Flat  
FWHM / FWTM 15.0° / 30.0°  
Efficiency 80 %  
Peak intensity 8.7 cd/lm  
LEDs/each optic 1  
Light colour White  
Required components:

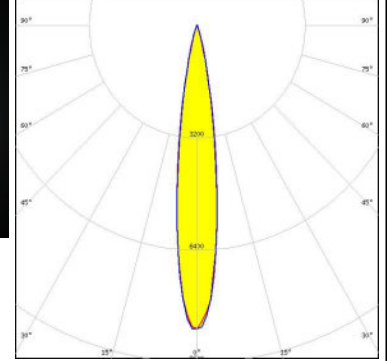
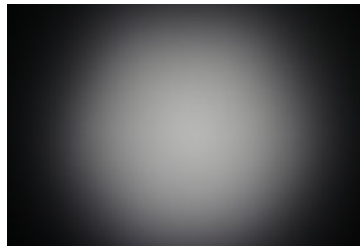

### GENERAL INFORMATION:

NOTE: The typical beam angle will be changed by different color, chip size and chip position tolerance. The typical total beam angle is the full angle measured where the luminous intensity is half of the peak value.

### MATERIALS:

As part of our continuous research and improvement processes, and to ensure the best possible quality and availability of our products, LEDiL reserves the right to change material grades without notice.

### PRODUCT DATA USER AGREEMENT AND DISCLAIMER:

The measured data in the provided downloadable LEDiL Product Datasheets and Mechanical 2D-Drawings is rounded and provided as reference for planning. LEDiL Oy's optical specifications have been verified by conducting performance testing of the products in accordance with the company's quality system. The reported data are averaged results of multiple measurements with typical variation. LEDiL Oy reserves the right to without prior notification make changes and improvements to its products.

LEDiL Oy assumes neither warranty, nor guarantee nor any other liability of any kind for the contents and correctness of the provided data. The provided data has been generated with highest diligence but the provided data may in reality not represent the complete possible variation range of all intrinsic parameters. Therefore, in certain cases a deviation from the provided data could occur.

LEDiL Oy reserves the right to undertake technical changes of its products without further notification which could lead to changes in the provided data. LEDiL Oy assumes no liability of any kind for the possible deviation from any provided data or any other damage resulting from the usage of the provided data.

The user agrees to this disclaimer and user agreement with the download or usage of the provided files.

#### LEDiL Oy

Joensuunkatu 13  
FI-24240 SALO  
Finland

#### LEDiL Inc.

228 West Page Street  
Suite D  
Sycamore IL 60178  
USA

#### Ledil Optics Technology (Shenzhen) Co., Ltd.

# 405 , Block B  
Casic Motor Building  
Shenzhen 518057  
P.R.CHINA

#### Local sales and technical support

[www.ledil.com/  
where\\_to\\_buy](http://www.ledil.com/where_to_buy)

#### Shipping locations

Salo, Finland  
Hong Kong, China

#### Distribution Partners

[www.ledil.com/  
where\\_to\\_buy](http://www.ledil.com/where_to_buy)